

BUILDING WITH EARTH

A CONSULTER SUR PLACE

Authors:

P. Doat, A. Hays, H. Houben,
S. Matuk & F. Vitoux (CRATerre, France)

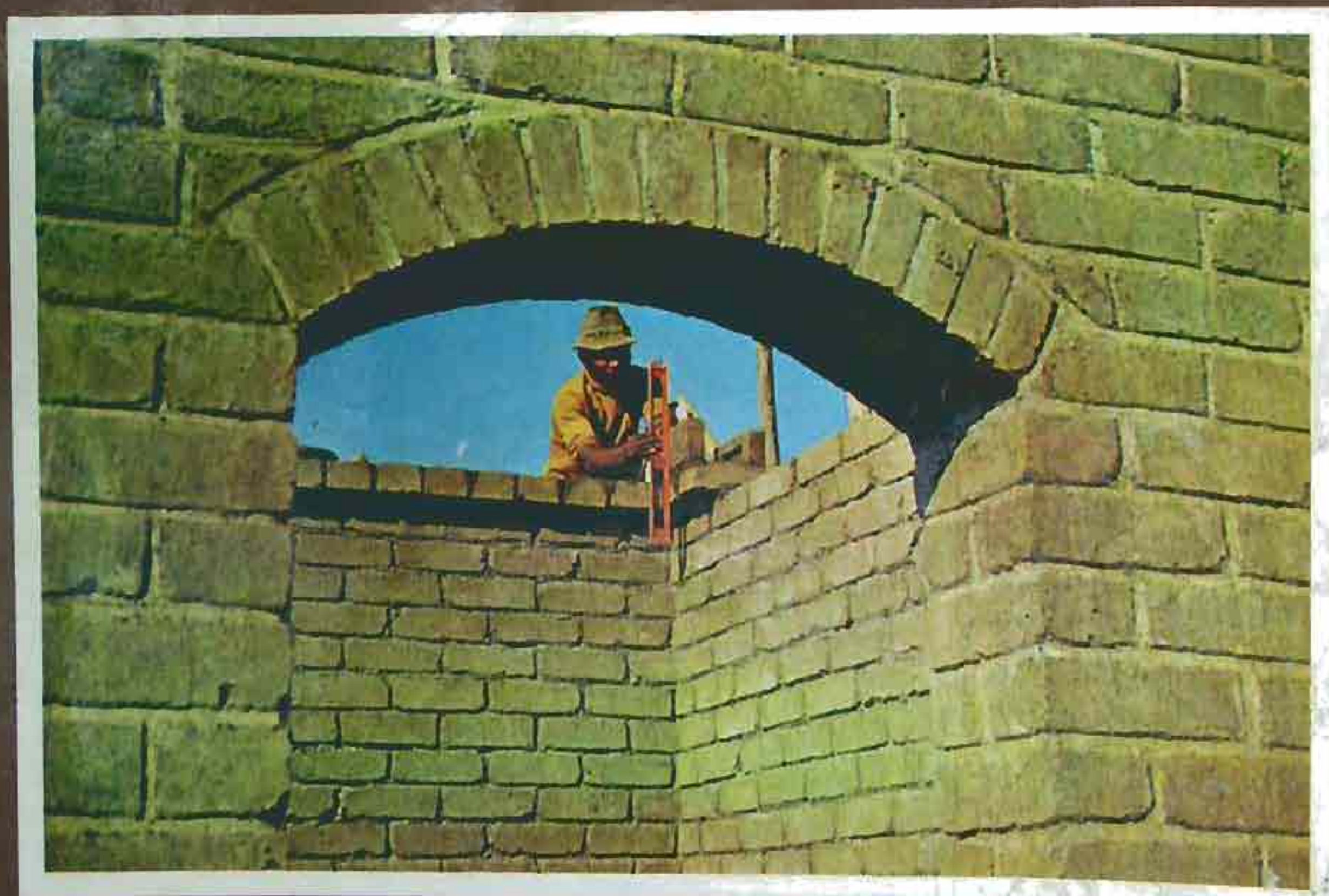

72



*the
mud village society*

BUILDING WITH EARTH

The industrial age revolutionized the value system by creating a system based on economic development with a focus on modern technology. The modern construction techniques and materials are cost and energy intensive. Whereas the modern concrete technology has caused the depletion of resources and energy, it has also caused the depletion of the earth's resources which have caused the depletion of the earth's resources.

The industrial age revolutionized the value system by creating a system based on economic development with a focus on modern technology. The modern construction techniques and materials are cost and energy intensive. Whereas the modern concrete technology has caused the depletion of resources and energy, it has also caused the depletion of the earth's resources which have caused the depletion of the earth's resources.

translated by Asha Puri
in collaboration with Manu Bhatnagar

revised by Claire Norton

The industrial age revolutionized the value system by creating a system based on economic development with a focus on modern technology. The modern construction techniques and materials are cost and energy intensive. Whereas the modern concrete technology has caused the depletion of resources and energy, it has also caused the depletion of the earth's resources which have caused the depletion of the earth's resources.

The industrial age revolutionized the value system by creating a system based on economic development with a focus on modern technology. The modern construction techniques and materials are cost and energy intensive. Whereas the modern concrete technology has caused the depletion of resources and energy, it has also caused the depletion of the earth's resources which have caused the depletion of the earth's resources.

The industrial age revolutionized the value system by creating a system based on economic development with a focus on modern technology. The modern construction techniques and materials are cost and energy intensive. Whereas the modern concrete technology has caused the depletion of resources and energy, it has also caused the depletion of the earth's resources which have caused the depletion of the earth's resources.

The industrial age revolutionized the value system by creating a system based on economic development with a focus on modern technology. The modern construction techniques and materials are cost and energy intensive. Whereas the modern concrete technology has caused the depletion of resources and energy, it has also caused the depletion of the earth's resources which have caused the depletion of the earth's resources.

The industrial age revolutionized the value system by creating a system based on economic development with a focus on modern technology. The modern construction techniques and materials are cost and energy intensive. Whereas the modern concrete technology has caused the depletion of resources and energy, it has also caused the depletion of the earth's resources which have caused the depletion of the earth's resources.

The industrial age revolutionized the value system by creating a system based on economic development with a focus on modern technology. The modern construction techniques and materials are cost and energy intensive. Whereas the modern concrete technology has caused the depletion of resources and energy, it has also caused the depletion of the earth's resources which have caused the depletion of the earth's resources.

The industrial age revolutionized the value system by creating a system based on economic development with a focus on modern technology. The modern construction techniques and materials are cost and energy intensive. Whereas the modern concrete technology has caused the depletion of resources and energy, it has also caused the depletion of the earth's resources which have caused the depletion of the earth's resources.



the
mud village society

24, Chitra Vihar (FF), New Delhi - 110092

Tel : 222-5338 FAX : (91-11) 222-3374

© First English Edition, 1991, **The Mud Village Society**, New Delhi, India.
Translated from the original third French Edition entitled *Construire en Terre*.

© Editions Alternatives, Paris, France, 1985.

All rights of the original French and this English edition are reserved.

Published with the assistance for translation by the Office of the
Counsellor for Cultural, Scientific and Technical Cooperation,
Embassy of France, New Delhi, India.

Production : Micron Computers & Allied Services,
Coordination : 55D, Pocket A, Sukhdev Vihar, New Delhi-110 025

Produced by : Design & Print

Typeset by : Wordtronic
111/56 Nehru Place, New Delhi-110 019

Printed by : Rakmo Press Pvt. Ltd.
C-93 Okhla Phase-I, New Delhi-110 020

FOR SALE ONLY IN SOUTH ASIA

(Bangladesh, Bhutan, India, Myanmar, Nepal, Pakistan & Sri Lanka)

the
mud village society

34, Chitra Park (N.T.), New Delhi - 110032

Foreword

The ancient Indian architecture had developed through the years reflecting the social systems of Hindu and Moughal Empires, the early ethnic values, the rise of power and had continued right up until the start of mechanical age. One characteristic of social values prevailed throughout the time span. It was autocracy — the minority rule, which manifested itself in the architecture of power and had no relevance for the general masses. These buildings consumed vast resources, time and energy. The present value system which has influenced the nature of design standards and ideals of today's architects, builders etc. is perhaps deeply rooted in the history of architecture.

The industrial age reinforced this value system by creating a myth based on economic development through exploitation and high technology. The modern building industry lays emphasis on sophisticated construction techniques and materials which are cost and energy-intensive. Whereas the recent concern regarding the environmental degradation, resource depletion and energy crisis have threatened the basic foundation upon which the modern economic empires have been built.

The process of urbanisation in the developing countries have created both rural and urban poverty and the large section of society are marginal both socially as well as economically. There is a need to evolve a value system in architectural practice which is based on need and survival. The architecture must become *natural* and must reflect a social system where individuals and communities build as they need shelter, warmth, protection and a sense of belongingness. The buildings should simply be constructed out of materials which possess natural characteristics of the different locations. Construction techniques must be simple, efficient and appropriate which would make building ecologically sensitive.

Buildings constructed in mud are cool in summers and warm in winter. They are energy efficient and are responsive to their natural surroundings. Interestingly enough, in various parts of the world, buildings are still made with mud. Therefore, it would be wrong to reject mud on the ground that it is an outmoded building material. Instead, it still can carve out a niche of its own and can be integrated into the designing and development process. There are number of ways of making this material impermeable with new mixture or special renderings and improve its durability and workability.

"Building with Earth" is a valuable and praise worthy research in this direction. This is a well written and brilliantly illustrated book, authored by five professionals from CRATerre, the International Centre for Earth Construction in France. This book provides an in-depth study on building with earth as it zooms over different continents and time frames upto the present day. If it helps in achieving a little change in the value system associated with our building industry, the purpose of this fruitful research would be met.

Housing & Urban Development Corp.
HUDCO House, Lodhi Road,
New Delhi-110003.

S.K. Sharma
Chairman & Managing Director
HUDCO

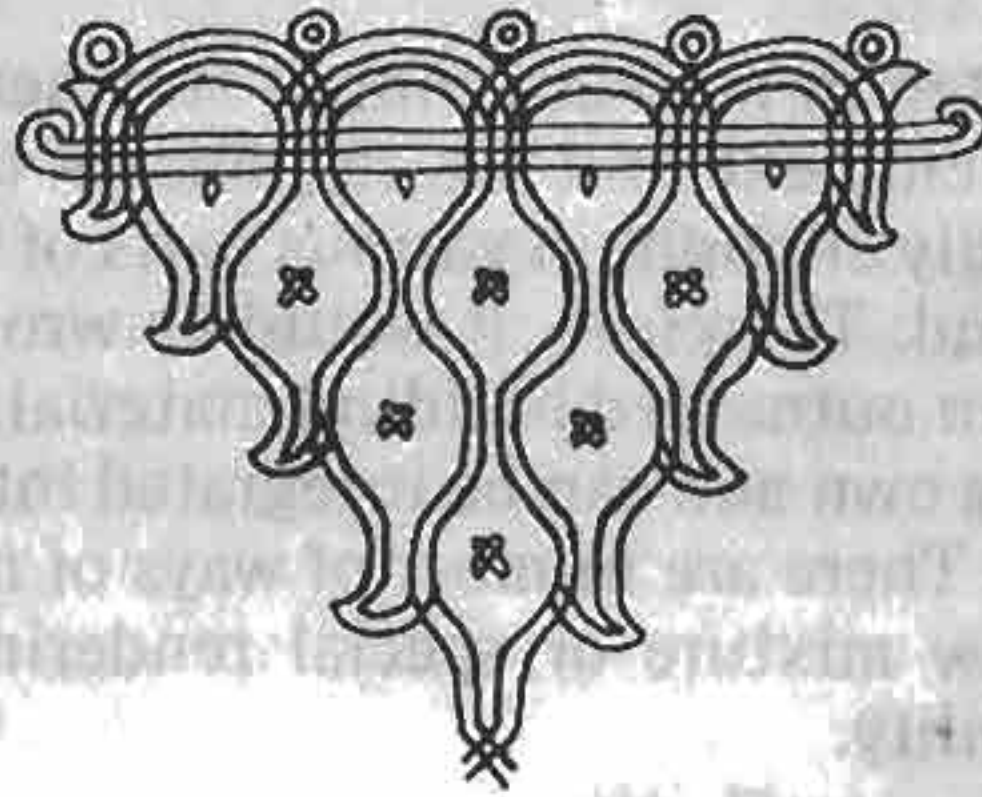

Publisher's Note

Across the world all those concerned with the serious issues of natural resource depletion and ecological disruptions are turning to the oldest, time-tested natural renewable resource of earth in the building industry. This industry is one of the major energy-guzzlers in terms of its production requirements, cooling, heating and lighting purposes. Moreover, the thermal performance of mud is remarkable, which has often been used with other local materials in our indigenous dubbed as *vernacular* building designs that are a direct expression of adaptation to local climate and resources. These are some of the finest examples of climate-responsive and energy-efficient building designs that harmonize with Nature.

Building with Earth goes in-depth into the earth construction process across different continents and historical periods. We see in each example that it is essentially a *local technology* rooted in time and space as opposed to a homogeneous, industrial product with its alleged *universality* accompanied with some ahistorical design that is passed off as an *international style* of architecture. Thus, this not another imported technology baggage but a well-documented piece of research by five professionals from CRATerre, the International Centre for Earth Construction in France, a premier NGO in this field.

We at MVS decided to bring out this vibrant publication of approx. 300 pages and 284 illustrations to the reader-users of the developing countries of South Asia at accessible rates. This entailed going into the *production* and *distribution* aspects ourselves bypassing the inflationary commercial publisher-distributor combine. A fifty percent discount will be given to students of architecture and engineering. Despite the translation, revision & vetting delays by which time we witnessed steep paper price hike, we managed to mobilise the necessary resources chiefly through institutional finance and individual credit-finance of our supporters, some of whom are listed below making it a *participatory* venture: 1) Mr. Anil Kumar Sharma, 2) Mr. A.G. Krishna Menon, 3) Ms. Kuku Chhiba, 4) Ms. Lajjawati, 5) Ms. Nutan Pandit, 6) Ms. Radha Kapoor.

The Council for Advancement of People's Action and Rural Technology (CAPART) were one of our major distributors whose assistance came as advance sales.

Lastly, it would not have been possible to bring out this publication in English without the translation assistance given by the French Embassy and the pivotal role Ms. Danielle Wozny had played in liasing and even giving critical translation assistance in various parts of the text.

February 1991

Nina Kapoor
Executive Director
The Mud Village Society, New Delhi

Publisher's Note

The world of architecture is a vast and diverse one, and it is our aim to provide a platform for the best of it. In this issue, we have a special feature on the work of the late architect, Mr. A.C. Kishore. His work was a blend of traditional Indian architecture and modern architectural techniques. He was a pioneer in the use of concrete and steel in Indian architecture. His work was a blend of traditional Indian architecture and modern architectural techniques. He was a pioneer in the use of concrete and steel in Indian architecture.

Building with earth has been the main construction process across different continents and historical periods. We see in early civilisations that it is essentially a local technology rooted in time and space. It is accompanied with some historical design that is rooted in the local conditions of architecture. Thus, the architectural design is not a universal technology, but a well-documented history of design. The international profession from CRATP, the International Commission for the Study of Architectural and Town Planning Problems in France, a pioneer NGO in this field, has been instrumental in the study of earth building.

We at MVS decided to bring out this vibrant book which is a tribute to the earth building movement. The book is a collection of 284 illustrations by the author, Mr. A.C. Kishore, and 284 photographs by the author and other photographers. The book is a collection of 284 illustrations by the author, Mr. A.C. Kishore, and 284 photographs by the author and other photographers. The book is a collection of 284 illustrations by the author, Mr. A.C. Kishore, and 284 photographs by the author and other photographers.

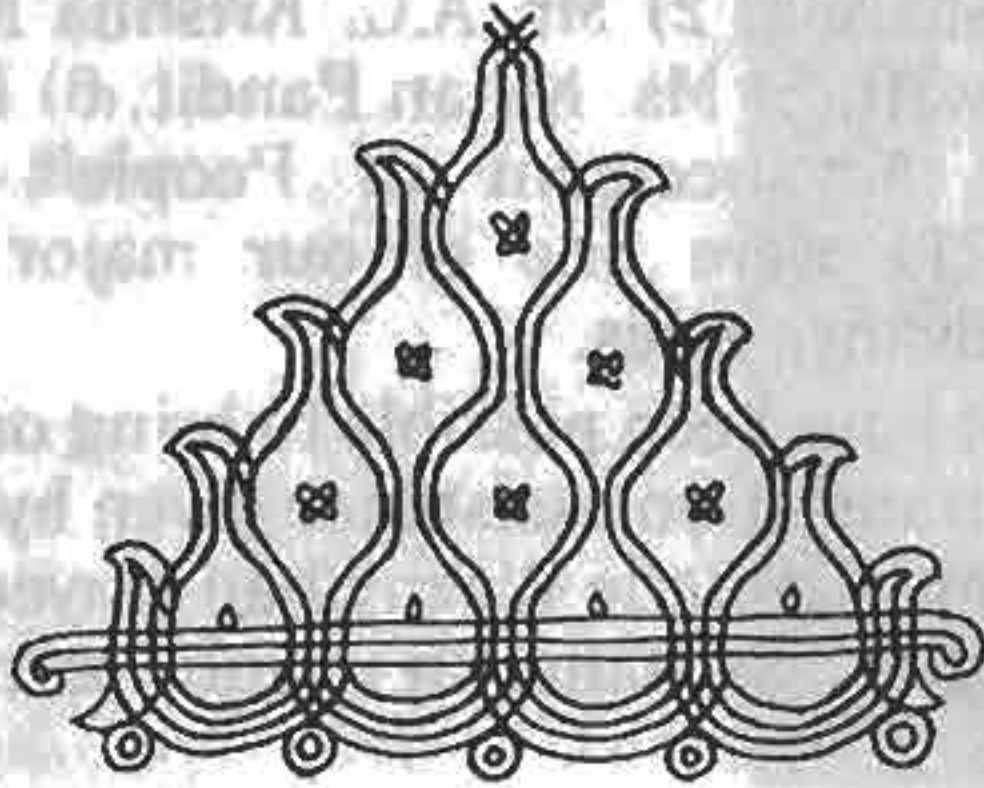

The Mud Vihara Society, New Delhi
February 1991

TABLE OF CONTENTS

PREFACE	4
ABOUT THE AUTHORS	7
ACKNOWLEDGEMENTS	7
1ST INTRODUCTION	8
2ND INTRODUCTION	9
TABLE PRESENTING THE VARIOUS APPLICATIONS OF EARTH	11



1. RAMMED EARTH CONSTRUCTION

I - TRADITIONAL RAMMED EARTH BUILDING

• Tools used	13
- Formwork	13
- End-board	15
- Vertical posts	15
- Putlocks	16
- Wedges	16
• The soil used	17
- Selection	17
- Extraction and preparation	17
• Building the walls	21
- Methods used in the Auvergne and Lyonnais regions (France)	21
- Vertical and slanting joints	22
- The "Bugey" method	24
- Wall thickness	25
- Ring or tie beams	26
- Corners	26
- Openings	27
- Floors	28
- Gable-end walls	28
- Roofing	28
COINTERAUX IN 1790	29
• Traditional house of the Lower-Dauphiné regions (France)	30
• Rammed earth building in 1972 (Conversation with a carpenter)	34
• Rammed earth construction in Morocco: another dimension	37
• Rammed earth in the Andes Cordillera: Tapia	39
II - RAMMED EARTH TODAY	41
• Problems relating to the material	44
- Choosing a suitable soil	44
- Stabilization	44
- Compaction	45

• Compaction	45
- Manual compaction	45
- Mechanized compaction	48
- Impact compaction machines	49
• Foundations	53
• Formwork	53
- Rigidity	53
- Stability	53
- Manoeuvrability	69
- Correcting the plumb	69
- The problem of putlocks or transverse ties	69
- Scaffolding	69
- Upper transverse ties	69
- Corners	69
- Flexibility	70
- Incorporating prefabricated elements	71
- Distance between the formwork panels	71
- Lining	71
- Maintenance	71
- Special forms	71
- Shuttering of the entire building	71

VIGNIEU: THE CONSTRUCTION OF AN EXPERIMENTAL RAMMED EARTH HOUSE IN THE ISERE REGION (FRANCE)	73
THE FARMING VILLAGE OF MOSTEFA BEN-BRAHIM	82
- Climate	82
- Architectural description	82
- Technical description	83
- Financial considerations	88



A VARIATION: POURED LIQUID EARTH	91
- The Zeralda experience	91
- The Brazilian experience	91
2. DIRECT MOULDING AND COB	93
Black Africa	94
- One example of rural housing: the compound	94
- The construction of a round house	95



Earth building in North Yemen	98
Europe	101
- The material used	101
- Application	102
In conclusion	105

3. ADOBE

I - Making adobe bricks	107
● Brick production in ancient times	107
- Babylon	107
- Greece	108
- Egypt	108
● Soil selection	111
- Excavation	112
- Sieving	112
- Preparing the earth	112
- Stabilization	112
● Moulds and how to use them	113
- Inventory of adobe brick moulds	113
- Filling the mould	113
- "Ball" moulding or so-called wet impact method	113
- Using a mould with a base: so-called sand impact method	118
- Drying and stocking	118
- Mechanical moulds	119
- Large-scale production	119
- Other methods	120
- Cutting up an adobe "slab"	120
- Extruded adobe	120
● Wall building	121
- Mortars	121
- Masonry bonding patterns	121
- Protecting the corners	126
- Reinforcing the structure	126
- Reinforcing the masonry: reinforcing bars etc.	126
- Openings	128

AN ADOBE HOUSE IN A PERUVIAN PEASANT COMMUNITY EARTHQUAKES AND ADOBE BUILDINGS

- Factors likely to lead to building damage during an earthquake



● Cayalti Project	133
- Brick production at Cayalti	134
- Wall-building	135
● Lima project	135

4. COMPRESSED EARTH BRICKS

Manually compressed earth blocks	137
Presses	138
● Table of 28 presses	140

● Press characteristics	141
● CRATerre's "Palafitte" press	142
● Our selection of commercially available presses of particular interest	149
- Cinva-Ram	149
- Tek Block	149
- Ellson Blockmaster	151
- "Terstaram"	153
- C.L.U. 2000	153
- M.M.H. 2000	154
● Other commercially available presses	154-155
- A.B.I.	154
- Hallumeca	155
- Drosthalm L3	155
● The press museum	156

A PROJECT FOR SETTING-UP A BRICK-YARD IN ROSSO (MAURITANIA)

CHOOSING BETWEEN RAMMED EARTH, ADOBE AND COMPRESSED BRICKS

5. SOIL ANALYSIS

I. Soil composition	165
- gravel, sand, silt and clay	165
II. Soil identification	167
● Collecting samples	167
● Laboratory testing	167
- Particle Size Analysis	167
- Sedimentation Analysis	168
- Optimum particle size distribution	170

PARTICLE SIZE ANALYSIS OF RAMMED EARTH BUILDINGS IN THE LOWER DAUPHINE REGION (FRANCE)

- Consistency states	174
- Proctor test	175
● Site tests	176
- Smell, Chewing, Observing the shine, Touch, Hand-washing, and Visual observation tests	179



- Simplified sedimentation test	179
- Tests on the finer soil components	180
- Summary table	182
● Quick clay identification test (Emerson test)	182

6. THE CHARACTERISTICS OF EARTH AS A BUILDING MATERIAL



General characteristics	185
-------------------------	-----

Standardized tests	185
Norms and recommendations	186
7. STABILIZATION	188
• Definition and natural laws	189
• Stabilization in practice	190
- Stabilization of soils in the ground	190
- Stabilization of extracted earth	190
- Main physico-chemical stab.	191
- Some conclusions	192
Stabilization in practice	194
• Improvement through increased density	194
- Compaction parameters	195
- Effects of compaction	196
- Variation as a result of the method of compaction	198
- Conclusions	199
• Improvements through amending the particle size distribution	199
- Mixing soils	199
- Optimum particle size distribution mixes	200
Physico-chemical stabilization.	203
• Cement	204
- Constituents	204
- Earth	204
- Effects of cement-stabilization	207
- Conditions under which stabilization is applied	209
- Additives	210
• Lime	210
- Different kinds of lime	210
- The soil	211
- Effects of lime stabilization	211
- Conditions under which it is applied	212
- Additives	212
• Bitumen	212
- Terminology	212
- Principle of bitumen stabilization	213
- Fluidised bitumen or cut-back	213
- Emulsions	214
- Bitumen dosage	214
- The soil	215
- Effects of stabilization on bitumen	215
- Mixing	216



• Unconventional stabilizers	216
- Natural products	216
- Industrial products	218
- Commercial stabilizers	219

8. COMBINED TECHNIQUES 220

Timber-frame	221
"Earth and post" building	222
Horizontal elements	222
- Flooring	222
- Prefabricated elements	224

9. EARTH ROOFS 225

• Flat roofs	226
• Clay-bonded thatch "tiles"	226
• Mud brick vaults	229
- Design principles	230
- Vault building with formwork	230
- Vault building without formwork	231

• Domes	233
- Pyramidal vault	233
- Domes on squinches	233
- Domes on pendentives	234
- Building domes	234

0910. RENDERS AND PAINT 236

Renders	237
- Should earth buildings be rendered?	237
- Principles	237
- Various renders, and how to mix them	238
- Preparing the wall	240
- Applying the render	241
- Stabilizers	242

Paint	243
- White-wash	243
- Banana juice	243
- Industrial paint	243
- Chemical products	243
- Natural products	243

11. MECHANICAL MIXERS 245

Table	246
Characteristics	247
Mixer models	249
- Turbomixer	249
- Vertical mixer	249
- Grindstone mixer	250
- Horizontal mixer with baldes	250
- Linear mixer	250
- Motor-cultivator with milling cutters	250

WHAT IS NEW AT CRATerre ? 251

- CRATerre	251
- CRATerre Peru	251
- Membership	252
- Recent, current and forthcoming events	252
- Did you know?	253
- New projects	254
- Studies	255
- Courses	255
- Presses	256
- Extruded products	259
- Pulverisers	259
- Mixers	261
- Formworks	261

BUILDING WITH EARTH IN PERU 262

A medical center in compressed earth blocks: the introduction of a non-traditional technology	263
Producing a new press: the search for a suitable tool	264
The "CRATerre" press: specification	265
A typical faena day	266
The building stage: compressed earth blocks and eucalyptus reinforcements	267
Specification of the medical center	267
La Punta: an adobe agricultural warehouse: improving a traditional technology	269
Specification of the agricultural warehouse	270

RECENT, CURRENT AND FUTURE RESEARCHES AND ACTIVITIES—AN OVERVIEW 273

GLOSSARY 275

LIST OF ORGANISATIONS 279

BIBLIOGRAPHY 281

The merits of earth as a building material no longer need to be spelt out. And yet despite the fact that it has been used in numerous places throughout the world since prehistoric times, it seems that today this material is in need of some reevaluation.

It has been the victim on the one hand of the general devaluation associated with minor architectures and on the other of its own unstable nature. Architecture was in stone, which would last forever, or not at all. But theoretical certainties are once again being called into question, the process of architectural democratization has been set in motion and once again, economic considerations have begun to dictate choice.

Hence the fact that earth, freely available, malleable, easy to work with, endowed with remarkable qualities of plasticity and thermal inertia, has caught the eye of the experts. What we are now witnessing is the transfer of knowledge from craftsmen and builders who will soon have lost touch with the techniques that have been handed down over the millennia, to specialists who are attempting to record the accounts of those who have kept this ancestral skill alive. Where they once scorned these humble techniques and skills, architects have now begun to reappraise them, elevating them to the ranks of scientific knowledge and experimentation. The balance is being redressed, and rightly so, but will this rehabilitation be enough? The image architects themselves have created is reflected back to them, and they find themselves up against the contempt of the public at large, which concedes the use of earth reluctantly, if at all.

Pleading the case for earth will be a lengthy process, requiring a great deal of experimentation and a great deal of convincing. The architectural qualities of vernacular architecture must be rediscovered: one has only to consider the many examples in the south-west regions of North America, amongst the decimated Indian population; in North Africa, at the edge of the Sahara, or again in West Africa, where many nations are struggling to shake off cultural colonialism; in the Middle East, where oil wealth threatens to condemn these more modest techniques at least for a time; and finally in China where the word used to describe the process of compacting earth for rammed earth construction also means to build.

Quietly and patiently, a team based in Grenoble, once students at the School of Architecture there and now architects, researchers and teachers, have over the years amassed a store of information, led numerous studies, given of their advice and conducted experiments at Vignieu in the Isère region (France), in Africa and in Latin America. They share with us here the fruits of their experience, their research, the skills they learnt on site, the technical details and practical tips which will be invaluable to anyone who wants to roll up their sleeves and get to work. The process of technical rehabilitation has begun; architectural examples which exploit to the full all the plastic and dynamic qualities of this material will surely follow.

Pierre Clément,

June 1979.

This book has been written jointly by the members of

CRATerre

**International Centre for the Research and
the Application of Earth Construction**

(see introduction to CRATerre page 254)



From left to right: Sylvia, Hugo, Alain, Patrice and Francois.

- DOAT Patrice** - Architect - France
- HAYS Alain** - Architect - France
- HOUBEN Hugo** - Engineer - Belgium
- MATUK Sylvia** - Architect - Peru
- VITOUX Francois** - Architect - France

With the collaboration of:

DAYRE Michel
IRIGM

- Engineer - France.
- Institute of Interdisciplinary Geological and Mechanical Research
Participation in the chapters of Soil Analysis and Stabilization.

SABATIER Nathalie
ADETEN

- Ethnologist, France.
- Association for the Development and Experimentation of New Techniques and Energy sources.

UPAG
ADAUA

- Architecture Teaching Unit of Grenoble.
- Association for the Natural Development of African Architecture and Urbanism.

This book has been corrected by
RWEGERA Damien — Ethnolinguist — Rwanda

We would like to thank all those who have helped us in our work:

Gilles Garby, member of GRET, Paris - logistical support.

Hildegard Erhart, West Germany - for her active cooperation.

Dirk Belmans
Bijan Rafii
Ignès Brito
Jacques Debiesse
Adolfo Saloma
Oscar Concha Bustamente
José Honores

The members of ADETEN for their collaboration:

Patrice Ambacher
Abdou et Sophie Ibnyahya
Guy Issanjou
Jean-Francois Lyon-Caen
Jean-Philippe Denis
Luc Bazin
Francois Coutos-Thevenot
Guy Schneegans
Yann Leberre
Francoise du Boisberranger

We would also like to thank:

Raph Sallis
Pierre Saunier
Evelyne Grange
Mr. and Mrs. Aimone
Gilbert Bérardin
Hassan Fathy
Francois Philippe
Anne-Monique Bardagot
Philip Langley
and the merry Palafitte team.

For documents, drawings, photos, texts:

Pierre Bonneville
Genevieve Bellon
Charles Boyer de Bouillane
Philippe Durand
Suzanne et Max Hirschi

And most particularly the inhabitants of Vignieu, André Grange, Mr and Mrs Chabou, Pierre Barthélémy who allowed us to conduct experiments on site, Mr Huguet - carpenter -, Albert and Marie for the warmth of their welcome and their recollections.

Introduction

This manual is the fruit of the collective efforts of all the members of CRATerre. Each chapter has been critically debated many times and represents the synthesis of our personal experiences. We might add that this has proved to be a fascinating and rewarding experience, both as regards our knowledge of the material and our understanding of the techniques used.

For us, building with earth means this: enabling the underprivileged to improve their living conditions, but also -thanks to this very special building material - allowing a new set of relationships to evolve, giving the end-user greater control over his or her living environment. The need to react against the domination of a certain type of "imperialism" in the production of the built environment is indeed urgent. Whether this response occurs at a local or a national level, as is the case in certain Third World countries, or on an individual scale, the problem has been stated and the various approaches to resolving it may well have many points in common.

This manual brings together a certain number of tests, studies, interviews and documents. We have drawn principally on the experiments in which we have been involved in France and in Algeria, on studies undertaken in the Dauphiné, Bresse and Auvergne regions of France, as well as in other European, African and Latin American countries, where we have been in touch with many organisations working on earth construction.

The almost total absence of publications in France on the subject prompted us to present the widest possible range of options. The main emphasis has therefore been laid on the material and its practical application. Our hope is that the reader will find the points of reference he or she needs in order to be able to select and develop solutions appropriate to his or her surroundings and ambitions. It is for this reason that we have chosen to combine examples from countries as diverse as the Yemen, Germany and Peru. Clearly, solutions developed in the context of particular socio-cultural and climatic conditions are not interchangeable, but we felt that their juxtaposition was one important way of stimulating creative ideas and research into original solutions.

VILLAGE DAUPHINOIS

Cliché Chollet



Cliché Chollet, burgliste — Chimilin

Earth is undoubtedly one of the most ancient construction materials known to man. The Persian, Egyptian, Assyrian and Babylonian civilizations all made abundant use of it and the examples which have come down to us show that our forefathers did not hesitate to use it in buildings of often huge proportions, such as the Ctesiphon arch in Iraq, nor from entrusting their most precious belongings to it for all eternity, witness the Egyptian (1st dynasty) pyramids and mastabas at Saqqarah. Less well-known are the Chan Chan ruins of Peru, the biggest pre-Columbian complex of South America, covering a surface area of 14 km².

Nor is earth architecture merely an archaeological curiosity; it is estimated that today more than half of the world's population lives in earth buildings.

As a building material it continues to predominate in nearly the whole of Africa, the Middle East and Latin America. It also represents one form of vernacular dwelling in China. In Europe, though largely forgotten today, earth buildings remain a familiar part of the everyday landscape. They are to be found in Sweden, Denmark, Germany and the East European countries, as well as in Great Britain and Spain. In France, there are numerous examples of various applications:

- rammed earth in the Dauphine, Lyonnais,

Auvergne, Brittany and Beauce regions;

- sun-dried bricks in the Garonne valley and on the Ile-de-France;

- lath and plaster in Alsace, Normandy, Picardy and Bresse;

- cob in the Vendee and Camargue areas.

Amongst industrialized countries today, there are two aspects to the current revival of interest in earth building. The first, which emerged in the South-Western states of the USA, is a response to the desire for a more "human" environment, an alternative to the cold and soulless technology which has come to be symbolized by concrete and plastic, those synonyms of modern progress.

Throughout the "South-West" (New Mexico, Arizona, Southern California) adobe (sun-dried brick) construction is currently witnessing an ever-increasing popularity. There are 28 adobe brick manufacturers in the region, 15 of them in New Mexico, as well as many small-scale professionals. With its roots in Indian and Spanish traditions, adobe architecture has acquired a regional character, unique in the United States. A recent survey into what adobe buildings meant to their users (conducted amongst 20 economically "better off" families, with incomes of over \$25,000 per annum, in the region of Tuscan, Arizona) revealed the emotional value placed on the material:

"The house is built with walls which are alive; people are against artificial things, plastic, and the manufactured world when it comes to their own 'natural' house 'growing' out of the earth".

"Adobe is at one with nature. Its thick walls give you a feeling of security. The adobe house provides a "center", it creates an environment which is in harmony with the South-West."

"The house is adapted to the context of the desert; it belongs to it."

Should this idea of the "naturalness" of earth be regarded as a passing phase or a response to

the failure of conventional architecture to meet the requirements of the inhabitants of houses?

The second consideration to have led to a revival of interest in earth construction is the accelerating rise in energy costs, which has an impact on products such as cement and fired bricks. McKillop has shown that if the energy needed to produce a fired brick is 2 Kw.h, a cement-stabilized brick of the same size requires only 0.05 Kw.h. Recent analyses of the "ecological costs" of construction methods which take account of the "social cost" (maintenance of communication networks, social services etc.) show that using the cheapest commercially available materials (cement blends) is perhaps not in the long-term the best solution.

Viewed in this light the ecological advantage of earth becomes self-evident. The answer may lie in sun-dried blocks. This is one of the techniques to evolve from the conventional brick-making process, but in which firing has been replaced by a greater degree of compaction and the use of stabilizers (cement, lime, chemicals). Thanks to this process entrepreneurs can manufacture and ensure the quality-control of products directly available on the market. German and Danish companies have developed sun-dried stabilized brick production units based on siliceous lime brick presses which are capable of reaching an hourly output of 1,500 bricks. Large scale brick-making plants can also be envisaged, but so too can small workshops using lighter equipment, such as hydraulic or mechanical presses.

Earth construction technology is today sufficiently confident to compete against conventional materials. Rooted firmly in popular tradition, it has all the advantages resulting from technological simplicity. Requiring very little capital investment, it is highly adaptable and suitable for use in widely differing production contexts: industrial or workshop production, owner-builder cooperatives, rural self-help builders, etc. Faced with a technology so rich in potential, one might ask oneself if it is right to add compressed bricks or SSC to the list of new products already on the market, or if this means of building might not afford the end-user the opportunity to control the creation of his own living environment.

To be able to fulfill the latter role, a technology has above all to possess potentialities for assimilation. Modern technology is becoming more and more remote from ordinary people. Sophisticated, therefore costly, and refined, it is now in the hands of the experts. Caught in the

very trap of their own progress, and anxious to protect their powerbase or at least to justify their role in society, the latter have gradually built up for themselves, thanks to standards, regulations and specifications, a kind of monopoly over technology and most of its day-to-day applications. House-building, for example, which was in traditional societies part of a common core of skills, has today become a science for professionals, confronted with which the end-user stands defenseless.

It is time that human beings re-appropriated the technical skills needed for their own development. However simple a technique, if it has not been re-appropriated by the group which would have made it theirs, it will remain inadequate. And this is all the more apparent in the case of Western technologies grafted onto environments quite incapable of absorbing them, as is often the case in the Third World, where all they achieve is the destruction of the structure and equilibrium of cultures often still seeking to establish their own identities.

One of the characteristics of earth construction is the wide range of its possible applications. In France alone we find rammed earth, lath and plaster, sun-dried bricks, and cob building - and in each case completely different buildings.

We describe here the techniques of rammed earth, poured earth, direct moulding, adobe (or sun-dried bricks), compressed bricks, as well as "combined" techniques in which earth is used in conjunction with another material (vegetable fibre or wood). These are the techniques most widely-known and used throughout the world. We do not consider fired bricks, cob on posts, excavated or trogloditic buildings, nor the very specialized techniques of cutting bricks directly from the ground, sod-building or projected earth.

The table (fig. 2) lists the possible applications of earth according to the "state" of the material at the time of its use: solid, plastic, liquid or dry. If the soil, when dry, displays approximately the same physical characteristics, however it was used, the degree of wetness or plasticity of the material will strongly influence the manner of its use. Techniques for moulding wet earth are quite different from those for dry earth, drying times vary enormously etc. The table thus highlights the possibilities open to builders for adapting the material by concentrating on varying its water content.

FIGURE 2

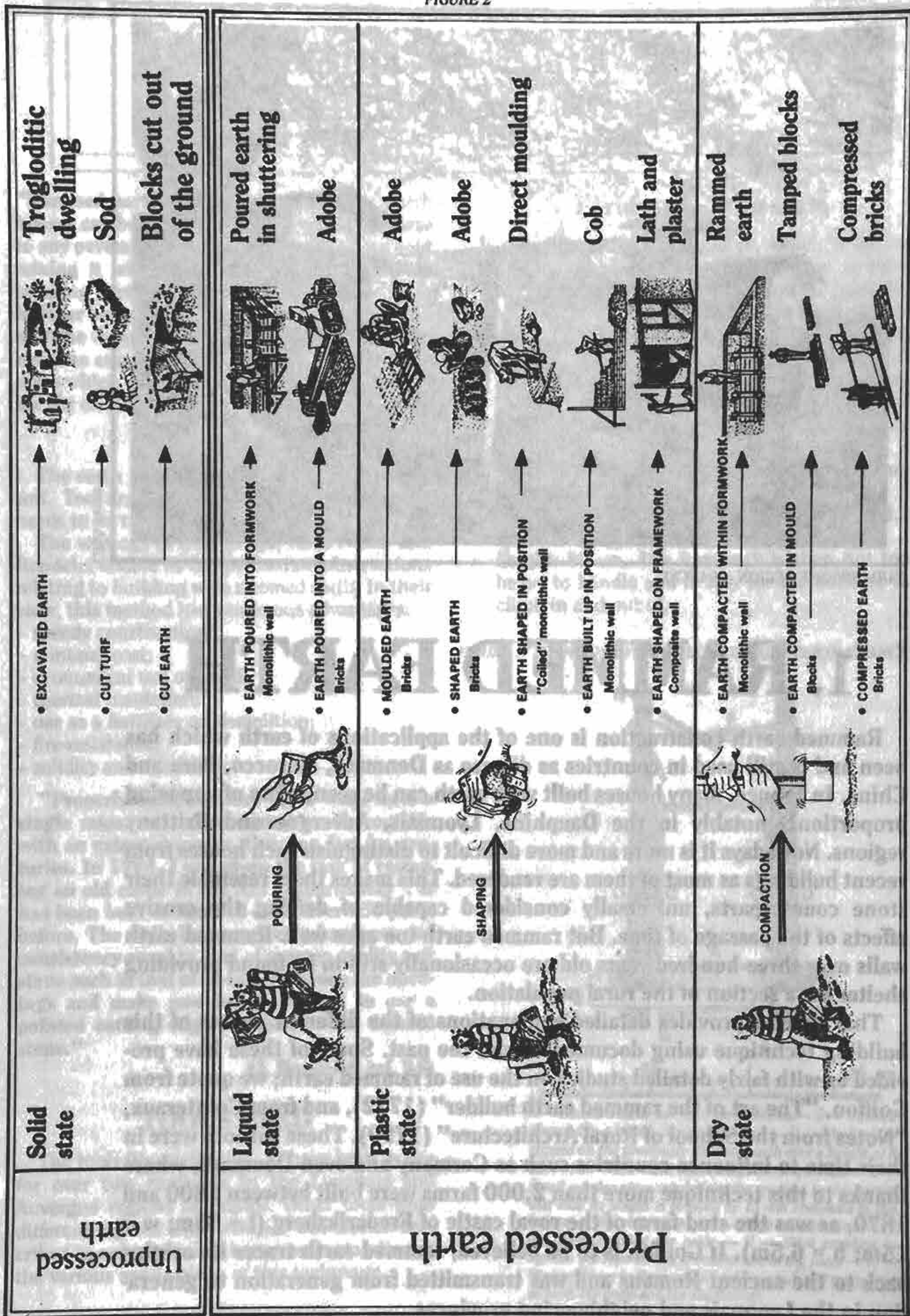

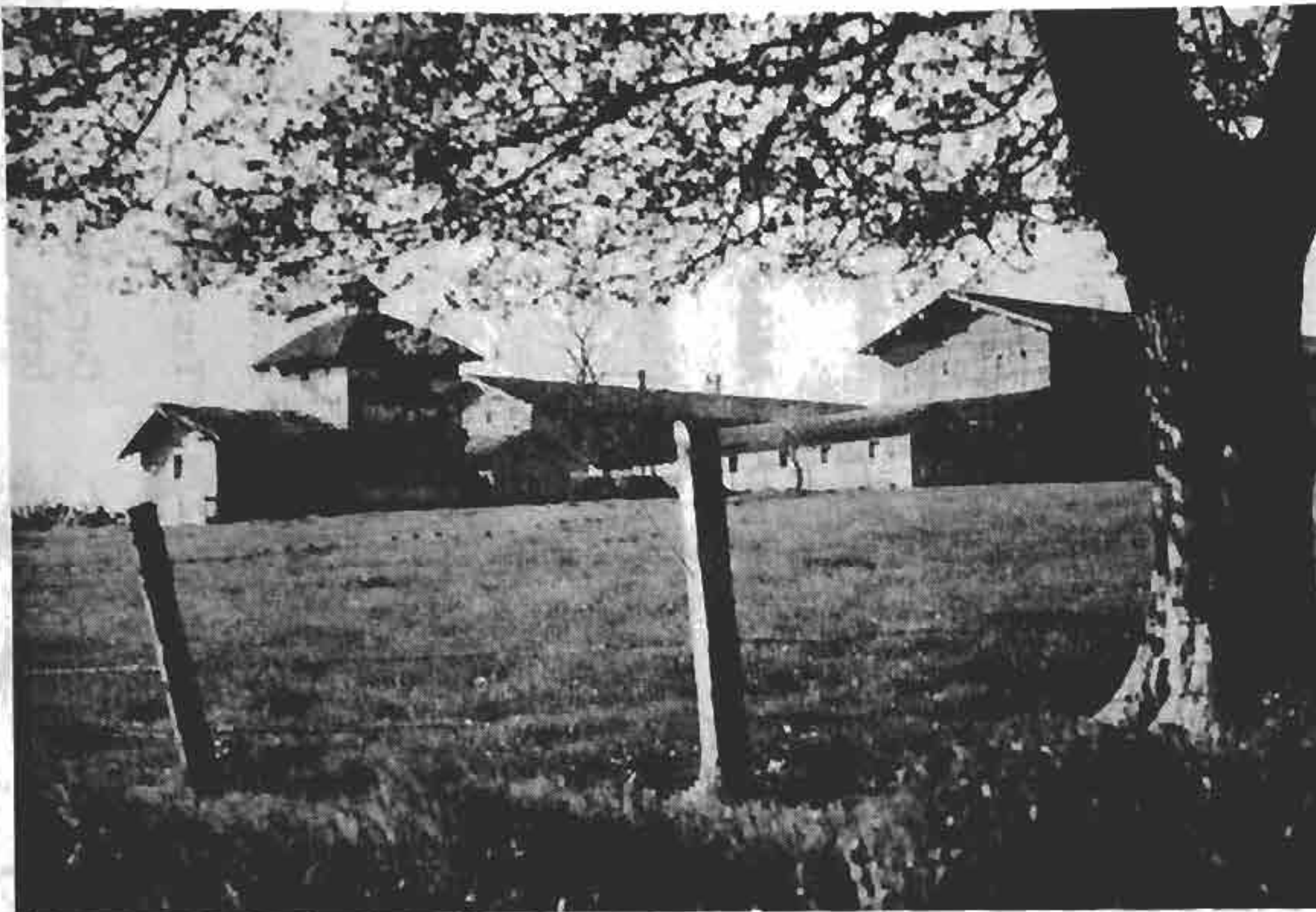

CRA Terre

FARM, BRESSE REGION (FRANCE).

1. RAMMED EARTH

Rammed earth construction is one of the applications of earth which has been and is still used in countries as diverse as Denmark, Morocco, Peru and China. In France, many houses built with earth can be seen, often of imposing proportions, notably in the Dauphiné, Lyonnais, Auvergne and Brittany regions. Nowadays it is more and more difficult to distinguish such houses from recent buildings as most of them are rendered. This makes them resemble their stone counterparts, universally considered capable of defying the erosive effects of the passage of time. But rammed earth too ages well. Rammed earth walls over three hundred years old are occasionally still to be found providing shelter for a section of the rural population.

This chapter provides detailed explanations of the different phases of this building technique using documents from the past. Some of these have provided us with fairly detailed studies on the use of rammed earth; we quote from Goiffon, "The art of the rammed earth builder" (1772), and from Cointeraux, "Notes from the School of Rural Architecture" (1790). These authors were in their time to influence countries such as Germany and even Denmark, where thanks to this technique more than 2,000 farms were built between 1800 and 1870, as was the stud-farm of the royal castle of Frederiksberg (l = 89m; w = 15m; h = 6.5m). If Goiffon is to be believed, rammed earth traces its origins back to the ancient Romans and was transmitted from generation to genera-

I - TRADITIONAL RAMMED EARTH BUILDING

“Rammed earth is a method thanks to which houses can be built with earth without recourse to any permanent wooden support, and without mixing it with straw or fibre. It consists in tamping earth prepared for this purpose layer by layer between planks to the normal thickness of stone walls. Once tamped, it sticks together, acquires consistency and forms a homogeneous mass which can be built up to any height suitable for dwellings.”

Cointeraux

The earth used is extracted directly from the soil. Too dry to afford adequate cohesion, it needs to be tamped.

The writings of Cointeraux, Abbé Rosier and Rondelet enable us to note certain observations relating to building with rammed earth. In their view, this method had numerous advantages:

- speedy construction;
- minimal cost;
- economical use of wood;
- thermal insulation;
- use as a fertilizer on demolition;
- fire-resistance;
- solidity and durability.

“Properly built, rammed earth walls form a single mass, and when coated on the outside with an external render, they can last for centuries. In 1764, I was given the task of restoring an old castle in the Ain “département”. It had been built of rammed earth over 150 years before. The walls had acquired a hardness and consistency equal to that of average quality soft stone such as that of St-Leu. To widen the openings and make new holes, we had to use a pointed cutting edge hammer, as for dressed stone.”

(J. Rondelet, ref. 24)

TOOLS USED

The tools illustrated (fig. 7) have been in use for over two centuries in the Lyonnais and Auvergne regions of France. Other tools from different regions and countries will also be described in order to gain a better understanding of the various applications of this technique.

Formwork (figs. 8 and 9)

Each side of the formwork, which is 90 cm high, is made up of three or four straight wooden planks (with as few knots as possible) approximately 3 cm thick, 3.25 m long, and 30 cm wide. The planks are planed in order to achieve a smooth surface on the inside and to prevent lumps of earth from sticking to them. They are then held together by four pairs of vertical planks, 27 cm wide for the two end pairs and 21 cm wide for the intermediate ones.

The dimensions recommended by Goiffon are as follows:

length: 2.60 m (minimum 1.6 m; maximum 4.2 m);

height: 80 cm. The formwork is then not too heavy to handle and is easy for the builders to climb in and out of.

FIGURE 8: FORMWORK FROM THE LYONNAIS REGION (FRANCE).

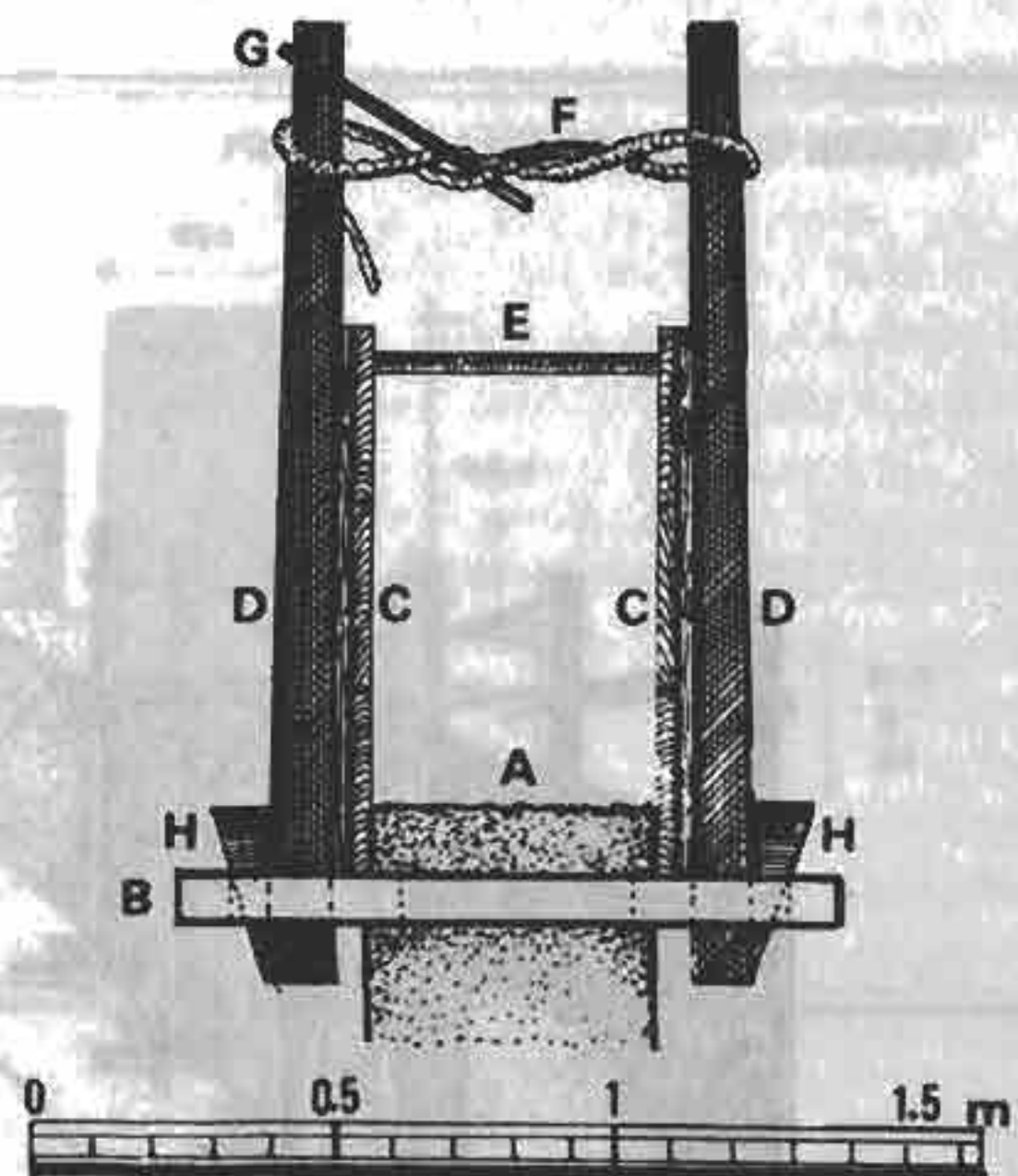

A — Rammed earth wall 48.6 cm thickness — B — Putlock disposed in a trench crossing the wall — C — Shutterings clipped on the previously Rammed earth over a height of 8 cm — D — Posts fixed with clamps in the putlock — E — Small wooden piece regulating the spacing. In this particular case its length is reduced by 13 mm compared to the bottom of the shuttering — F — Rope of approximately 7 cm diameter tying the posts — G — Stick enabling to tighten the ropes and fix it behind one of the posts — H — Wedger driven in the mortiser of the putlock and tightening as such the posts and the shutterings

Tools used for rammed earth construction

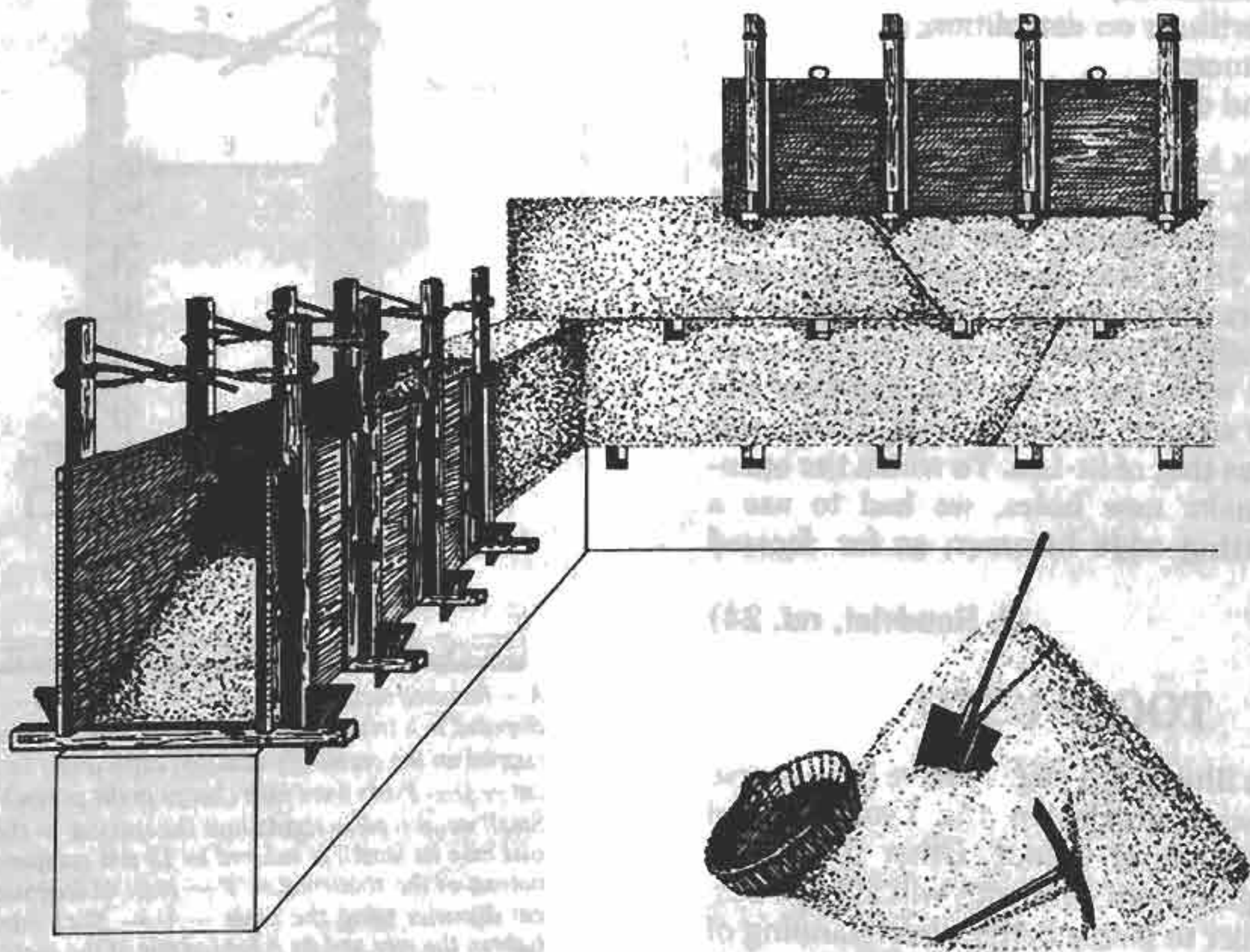
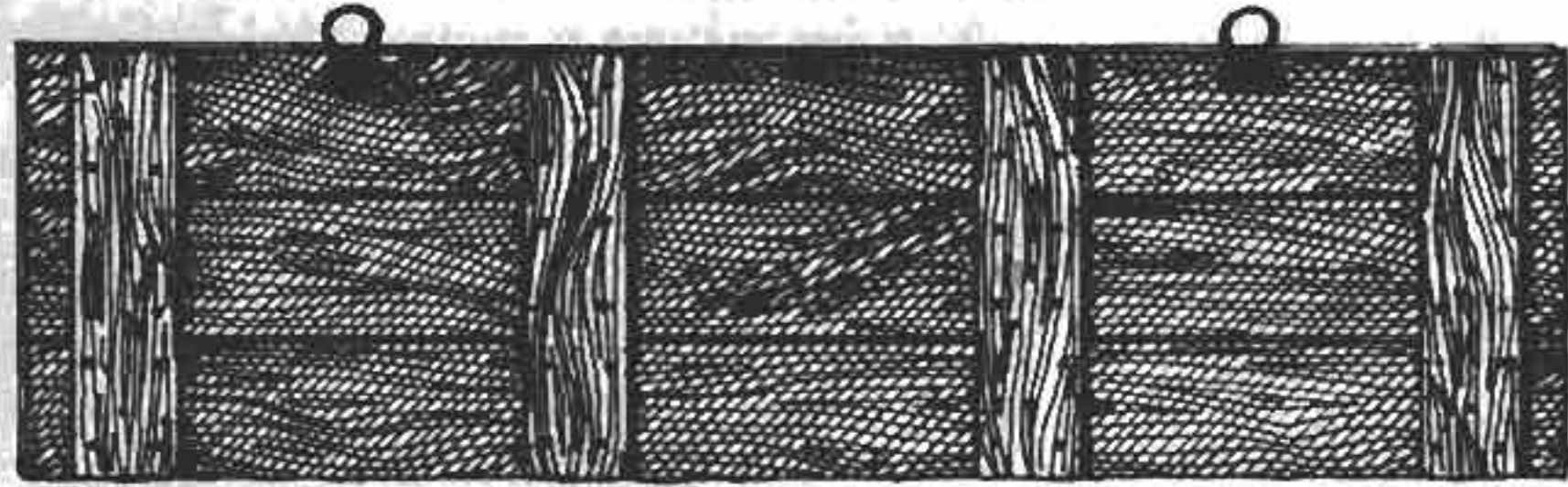
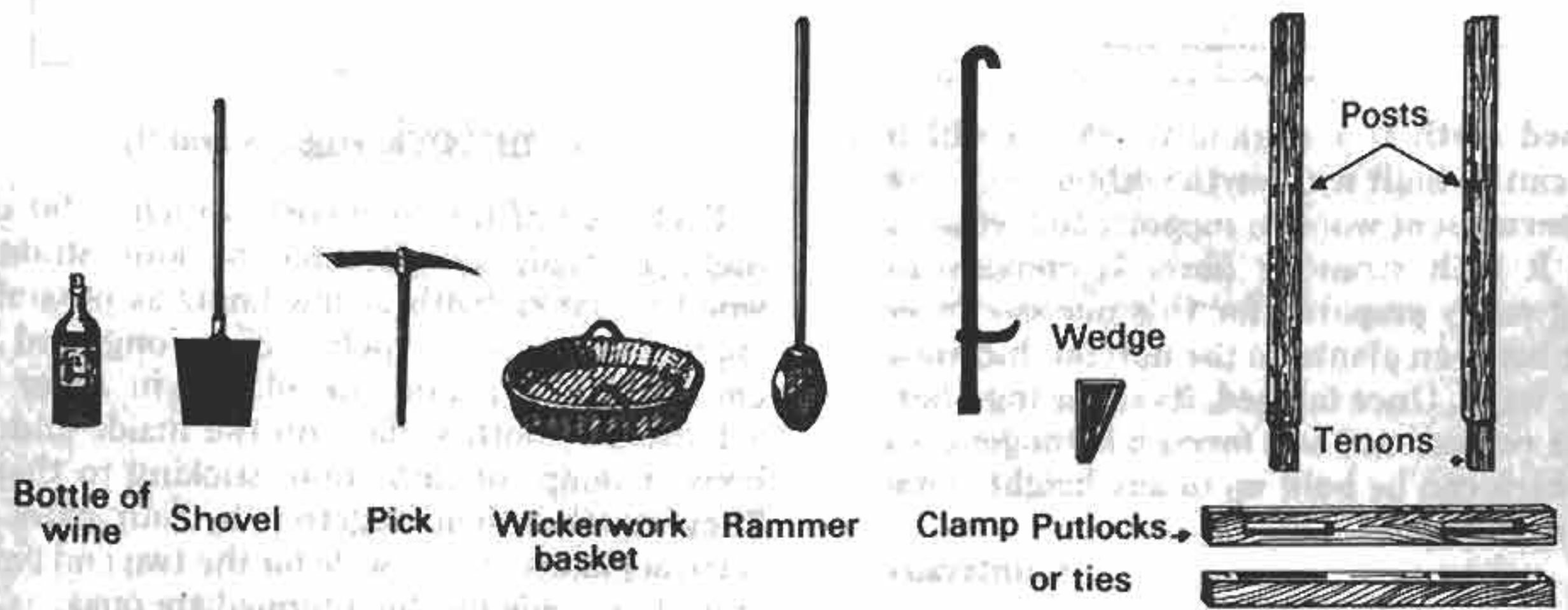

D'après J. Rondelet

FIGURE 9: FORMWORK SHUTTERING

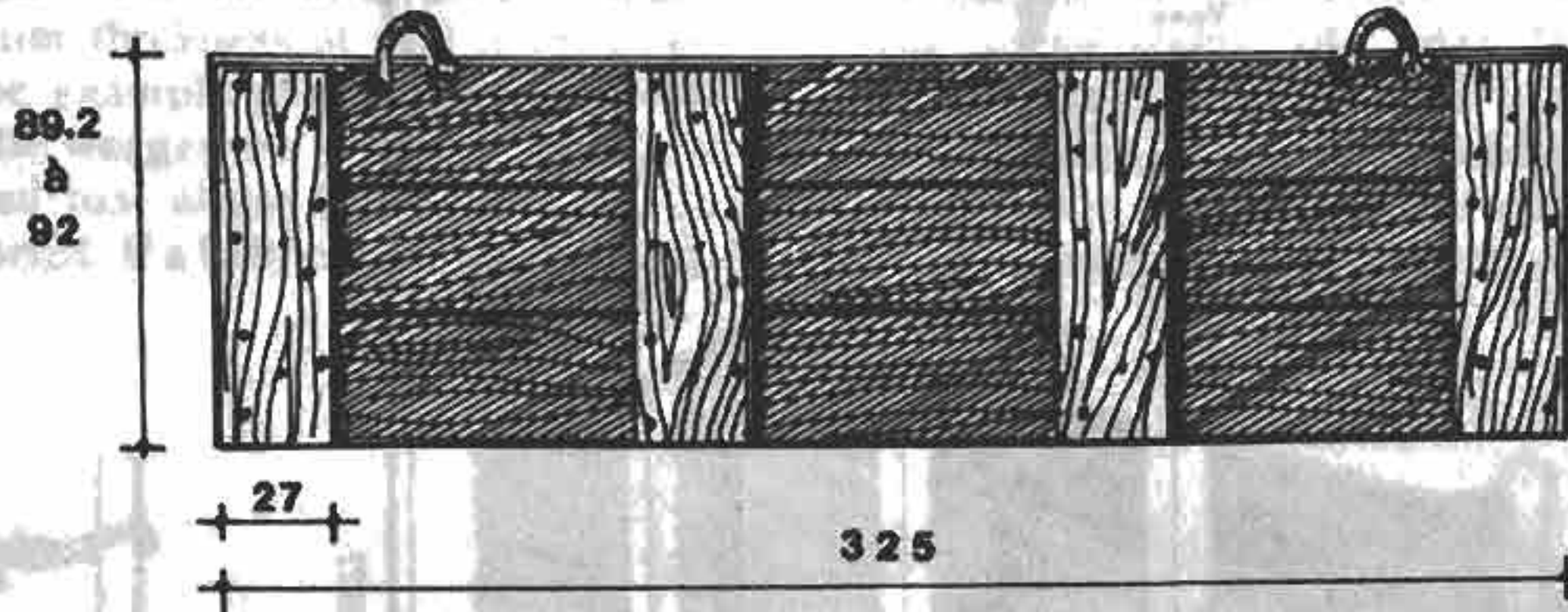

CRATerre from Cointeraux

The tongue and groove planks are knocked together and iron handles are added to make the formwork easier to manipulate.

In Auvergne in the Puy de Dôme region of France, the formworks differ slightly.

- The putlocks are cut out of rafters and are slightly conical in shape to make it easier to remove them from the walls (fig. 10).

End-board

Also known as the closer or formwork head (fig. 12), each "head" is made up of two planks held together on the outside by two small cross-pieces. Heads which are wider at the bottom than at the top allow the wall to taper.

FIGURE 10



Putlock in the shape of a pyramid frustum.

Auvergne (France).

CRATerre

- So-called "yokes" (fig. 11) are used to hold the vertical posts in place at the top. These yokes are not normally conical in shape, but a putlock can be used as a yoke, whereas the reverse is not true.

- In addition to the spacing sticks, "spreaders" are wedged on a slant between the vertical posts and are used to ensure that the formwork is vertical with the help of a plumb line fixed to the yoke and hanging down the inside of the formwork. The spreader lends rigidity to the rectangle created by the putlocks, the two vertical posts and the yoke, and prevents it from losing its shape.

FIGURE 12: END-BOARD AND WEDGE

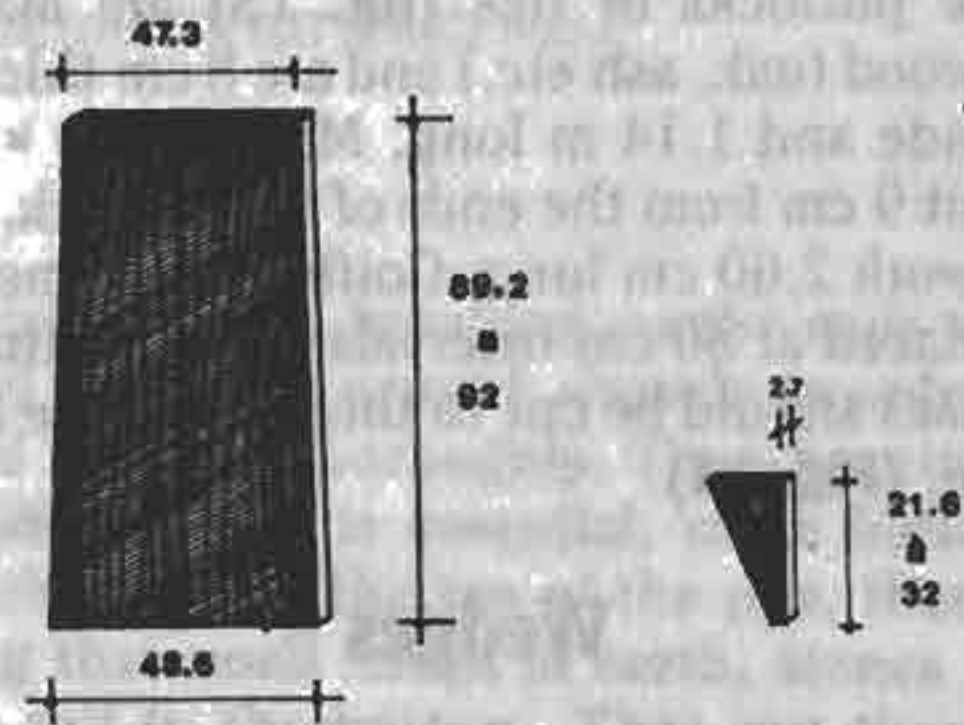

CRATerre from Cointeraux

Vertical posts

The posts or struts (fig. 13) 1.62 m high, are cut from sawn squared timber, rafters or joists. They protrude by at least 50 cm above the formwork. Goiffon suggests the following dimensions: height: 1.14 m; width: 5.4 cm. The posts end in a tenon 2.7 cm thick.

FIGURE 11: SHUTTERING FROM THE AUVERGNE REGION, FRANCE.

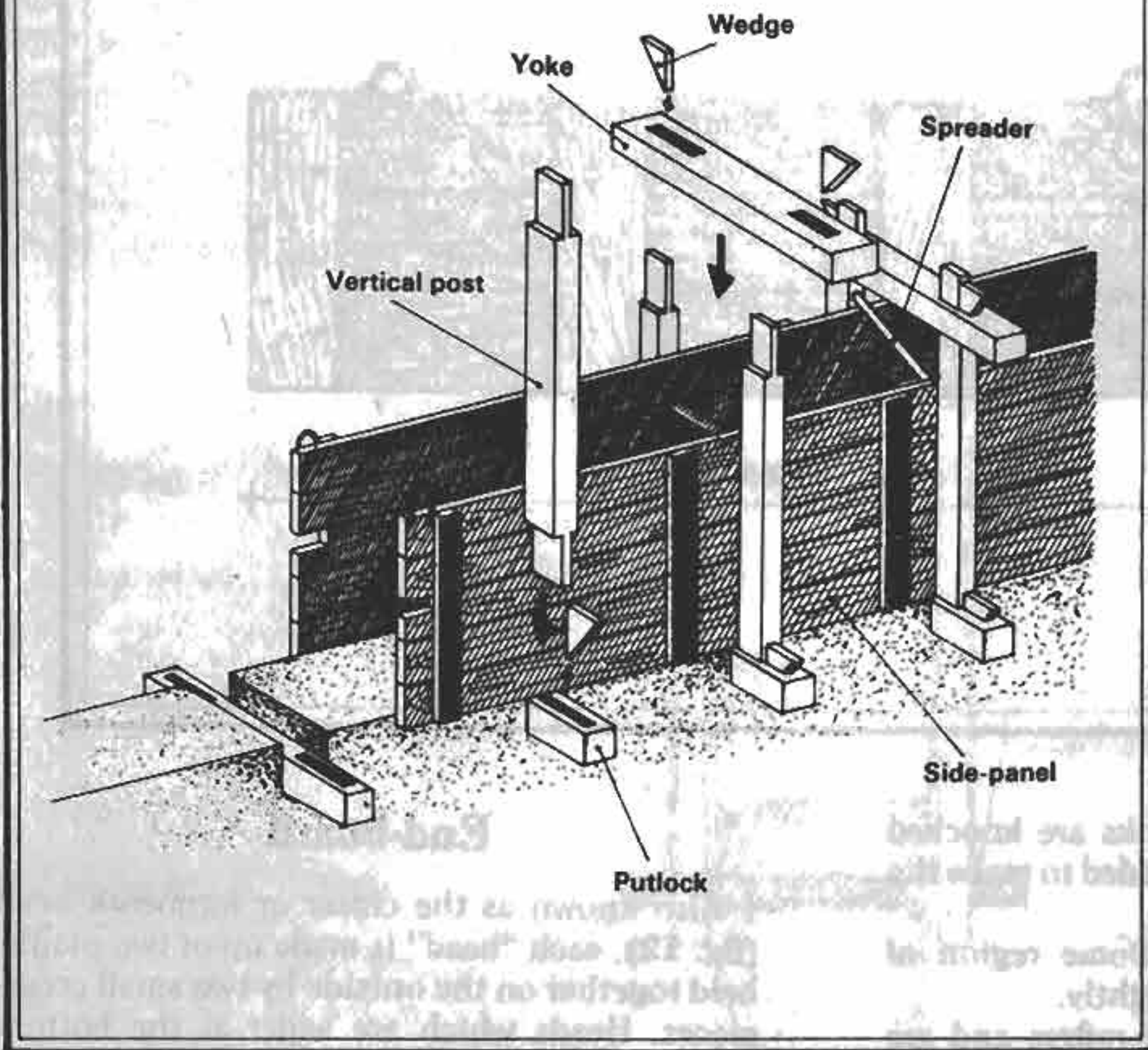

CRA Terre from Maison Paysanne de France n° 3, 1977

Putlocks

The putlocks or ties (fig. 13) are made of hardwood (oak, ash etc.) and are 8 cm thick, 9.5 cm wide and 1.14 m long. Mortises 20×3 cm are cut 9 cm from the ends of the putlock. For a formwork 2.60 m long, Goiffon recommends 4 ties placed at 80 cm intervals and adds that the mortises should be cut to the same angle as the wedge. (Fig. 14).

Wedges

The wedges driven into the putlocks brace the posts and thus the side-panels on the previous course of the wall. They play an important part in ensuring the perpendicularity of the formwork and the edge of the wedge adjacent to the posts should be completely vertical. The angle of the wedge on the other hand should be sufficiently small to ensure good bracing and the mortise is often cut to the same angle as the wedge.

According to how deeply they are driven in, they determine the thickness of the wall. For example, given a putlock with two 19 cm mortises, 43 cm apart, if the wedges are 11 cm wide and 43 cm high, and if the posts and side-panels

FIGURE 13: POSTS AND PUTLOCK

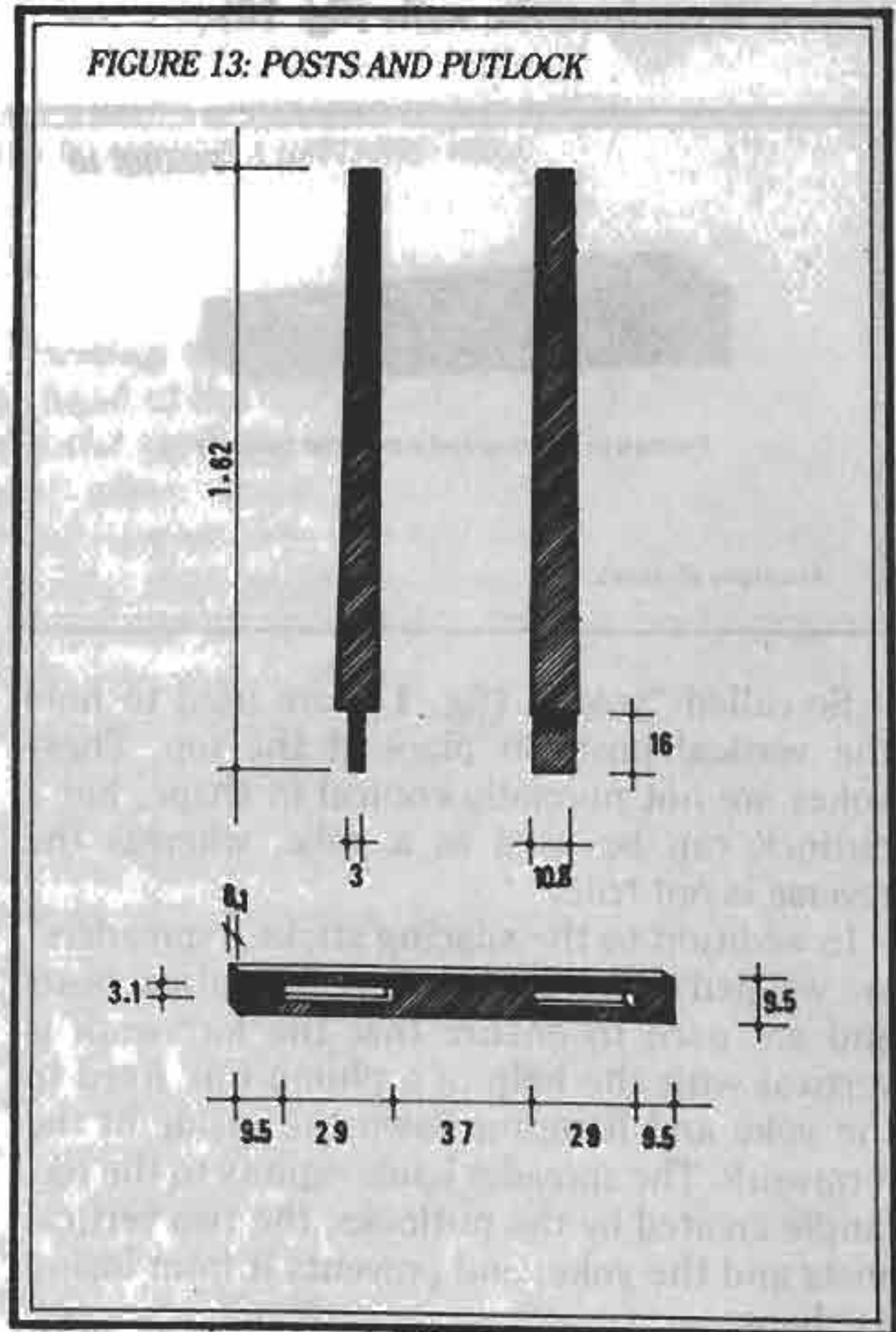

CRA Terre from Cointeraux

are 8 cm and 2.5 cm wide respectively, the minimum width of 38 cm will be obtained when the wedges are driven into the mortises to their maximum depth (fig. 14a).

If the wedges are driven in as little as possible, a maximum thickness of wall is obtained (54 cm in the example given) (fig. 14b). To ensure that the wedges are driven in equally a hole is pierced just above the putlock and a small pin inserted. If a battered wall is required,

that is with the outer surface leaning inwards (making it narrower towards the top as was very common in rammed earth buildings), a small extra wedge is inserted between the wedges proper and the external post. This is known as the "batter-wedge" (fig. 14c). The angle of the external surface of the wall is dictated by the dimensions of the wedge. A triangular wooden wedge at a slope 5 mm for every 32.5 cm in height served as a batter-wedge.

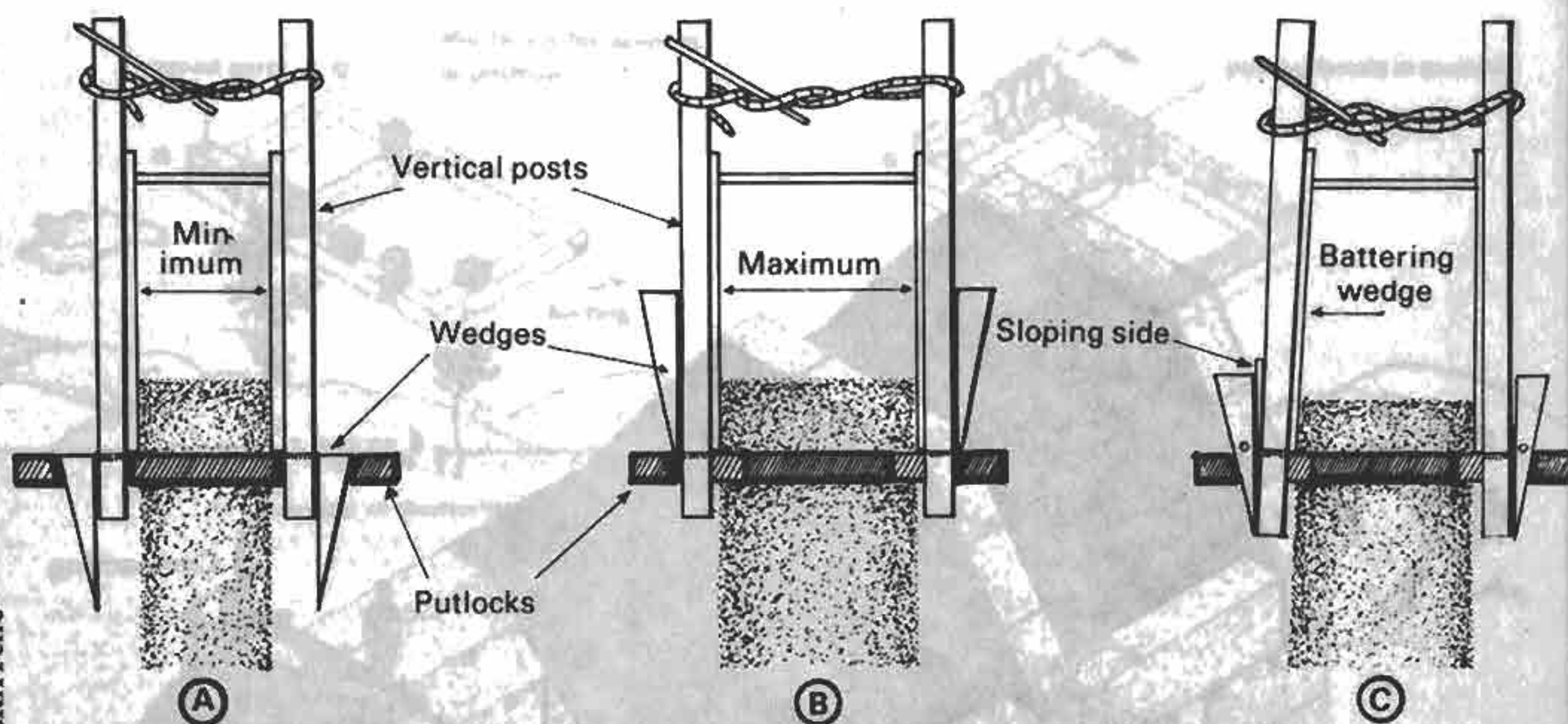

FIGURE 14 (a) and (b): THE GAP BETWEEN THE SIDE-PANELS VARIES ACCORDING TO THE DEPTH TO WHICH THE WEDGES ARE DRIVEN IN — (c) HOW TO ACHIEVE A BATTERED WELL.

THE SOIL USED

Selection

Not all soil is suitable for rammed earth construction. Ideally, the soil should be made up of:

- gravel: 0 - 15%
- sand: 40 - 50%
- silt: 35 - 20%
- clay: 15 - 25%

According to builders who used to use this technique in the Izeaux region (France), a "red" non-organic earth, not too wet, should be chosen, and building work should take place preferably in the Spring, when "the sap is rising" in the soil.

Extraction and preparation

According to Cointeraux, this requires:

"hoeing the soil, breaking up the sods with the head of the hoe or with shovels in order to split the earth up thoroughly. Then heaping it up in piles, which is essential, since builders always shovel onto the top of the pile, thereby ensuring that small lumps of earth, stones and pebbles roll to the bottom. They can then be easily removed with a rake which only pulls out stones and pebbles bigger than a walnut.

Only the quantity of soil that the builders can use during the course of the day is prepared in this way, and if it is likely to rain, a few planks, mats or canvasses must be kept at hand to prevent the rain from wetting the earth. Indeed, only earth which is neither dry nor wet can be used. It is impossible to tamp earth that has been soaked by rain, but one can moisten earth as necessary with a watering can.

All vegetable matter must be removed from the soil to be used: grass, bits of straw or hay, splinters of wood (...) which could decay (...)" 17

The site

(Axonometric view)

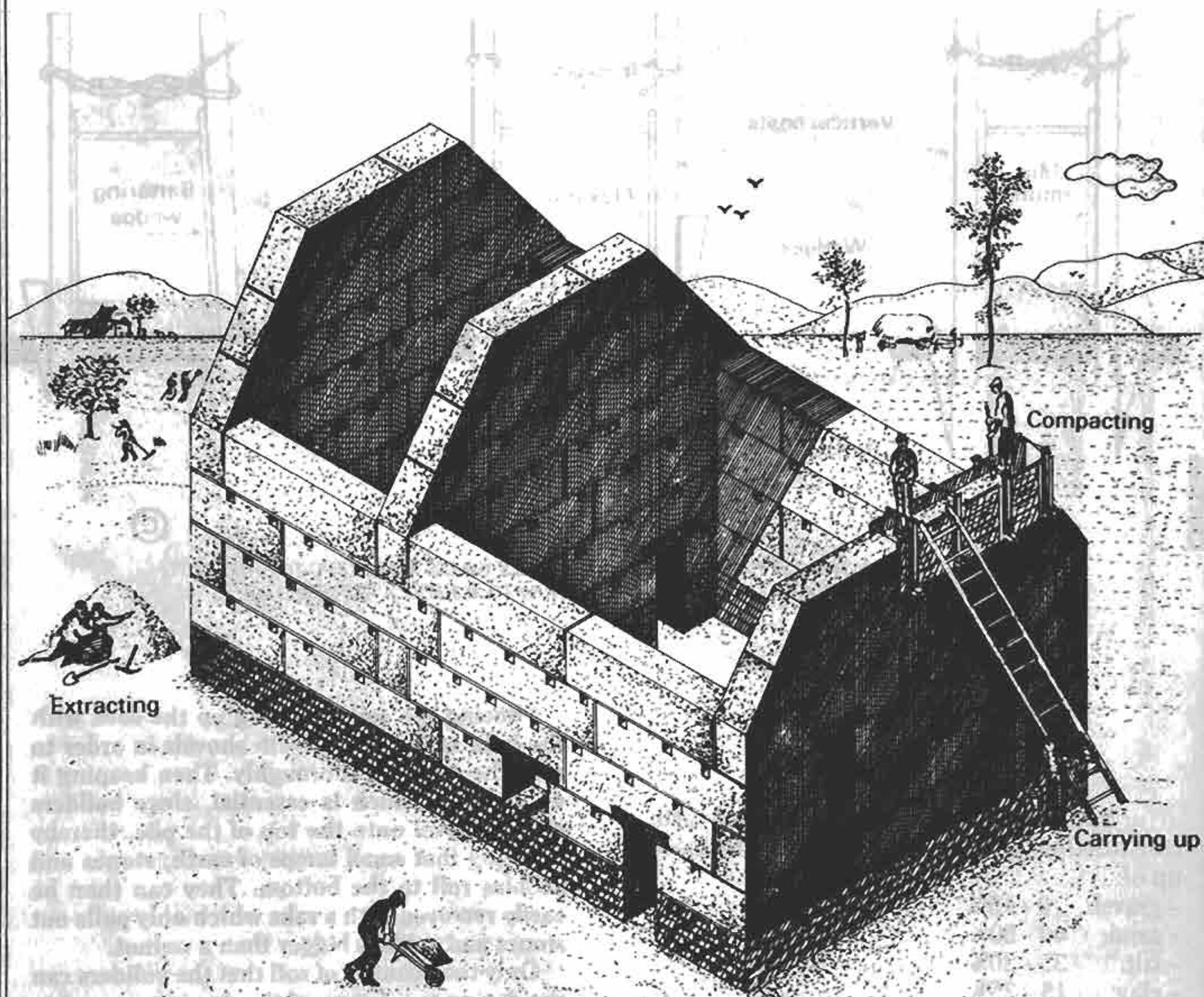

Compacting

Carrying up

Extracting

Transporting

FIGURE 16:

Watching a rammed earth house go up

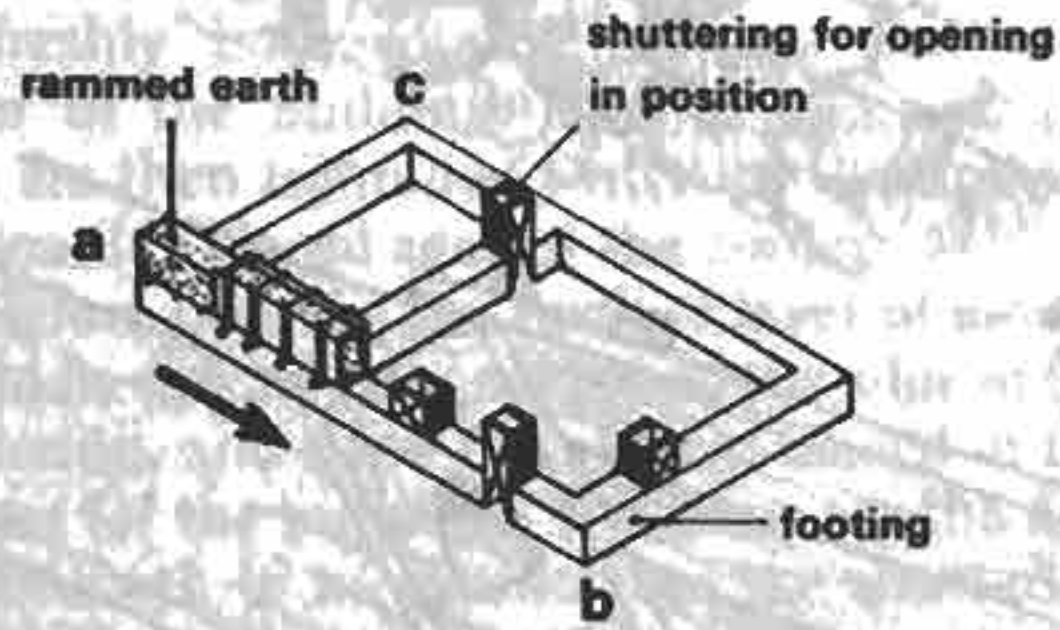

1st COURSE

direction of shuttering ab

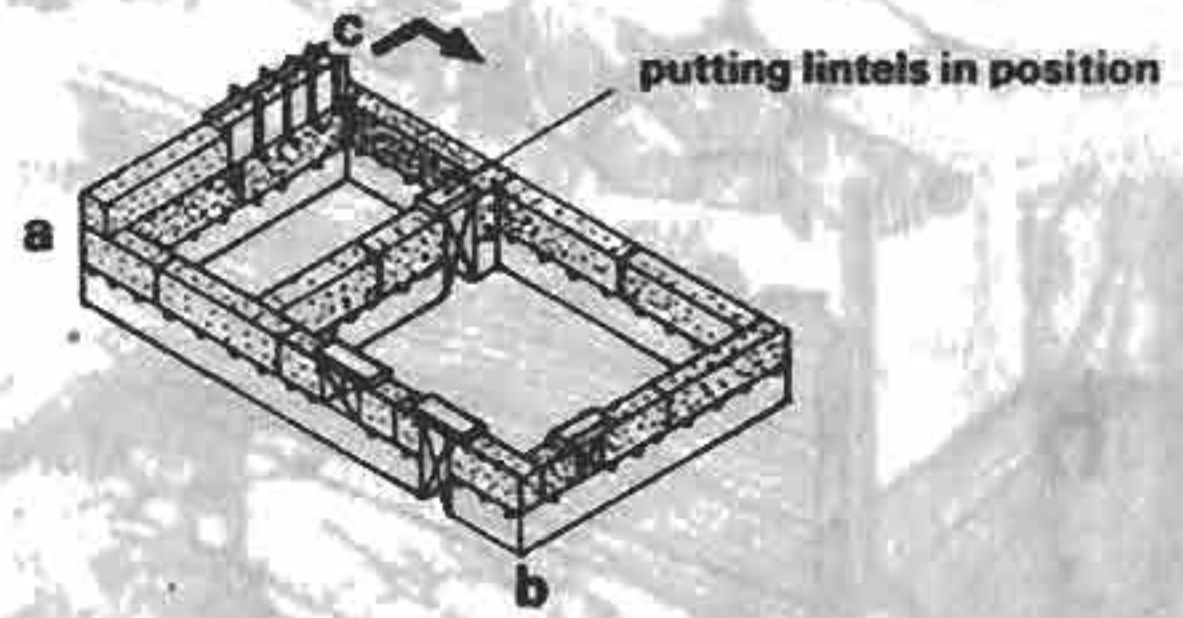

2nd COURSE

direction of shuttering ac

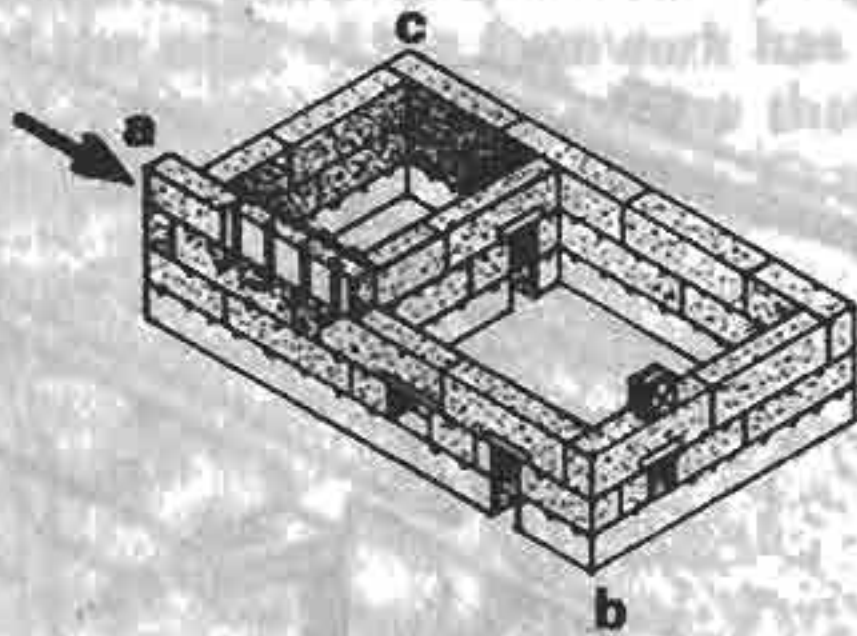

3rd COURSE

direction of shuttering ab

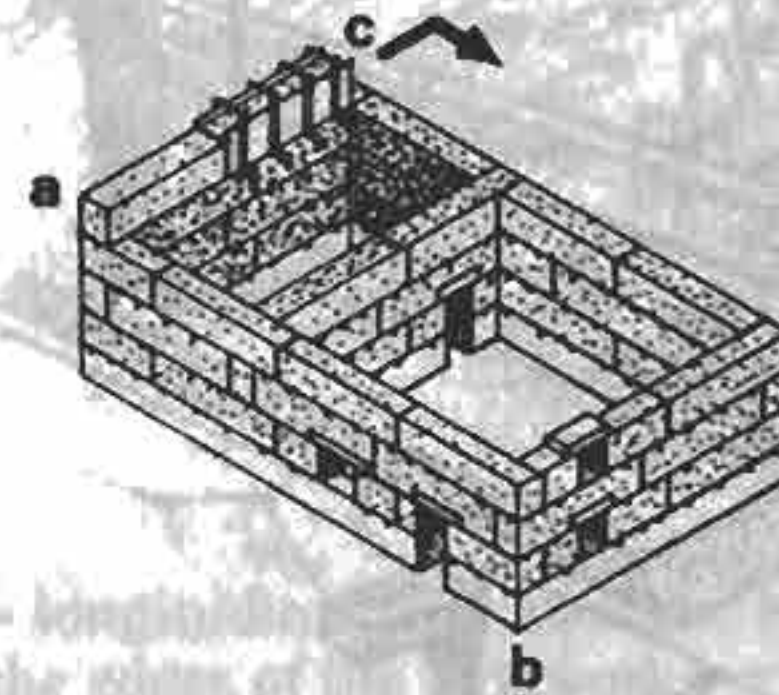

4th COURSE etc

direction of shuttering ac

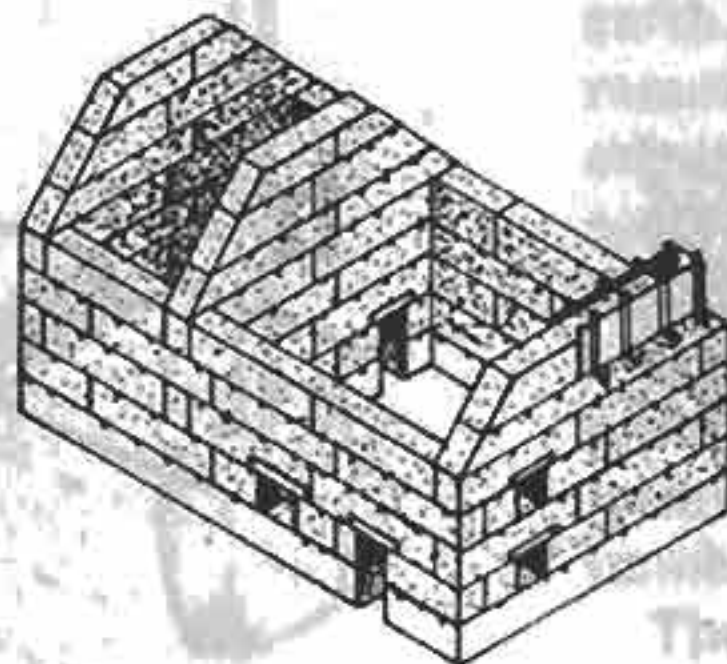

Building the gable-ends

FIGURE 17: BUILDING A SECTION OF RAMMED EARTH: THE VARIOUS STAGE

a

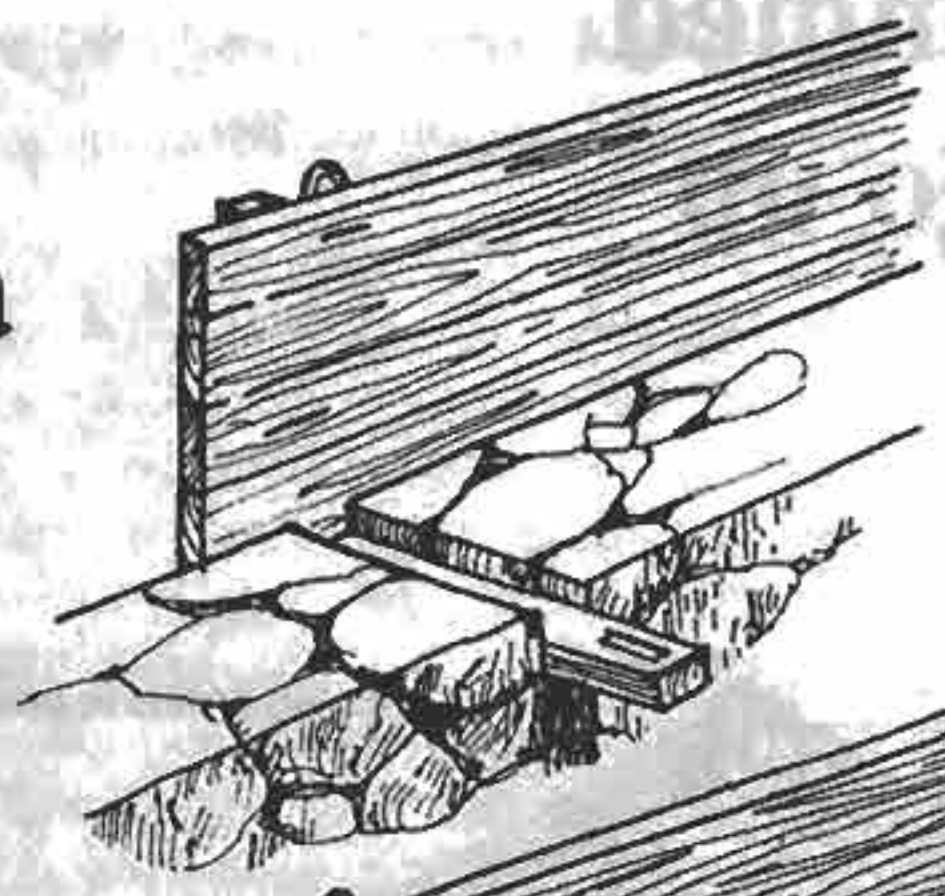

b

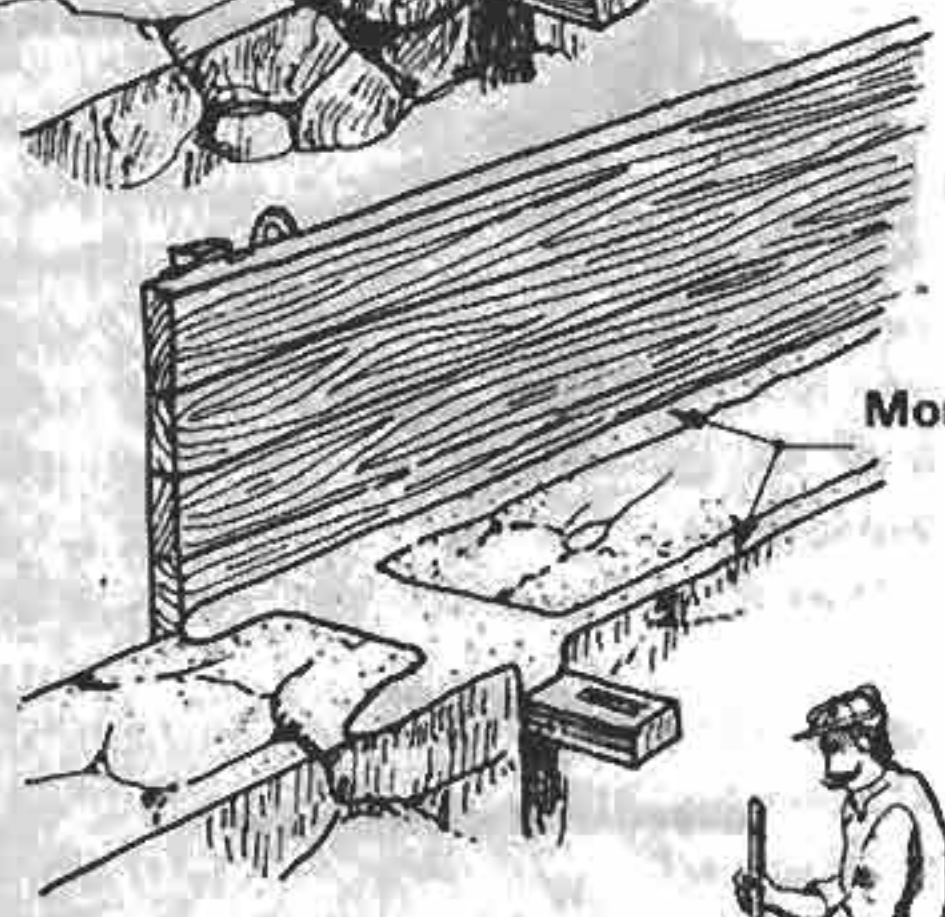

Mortar edging

c

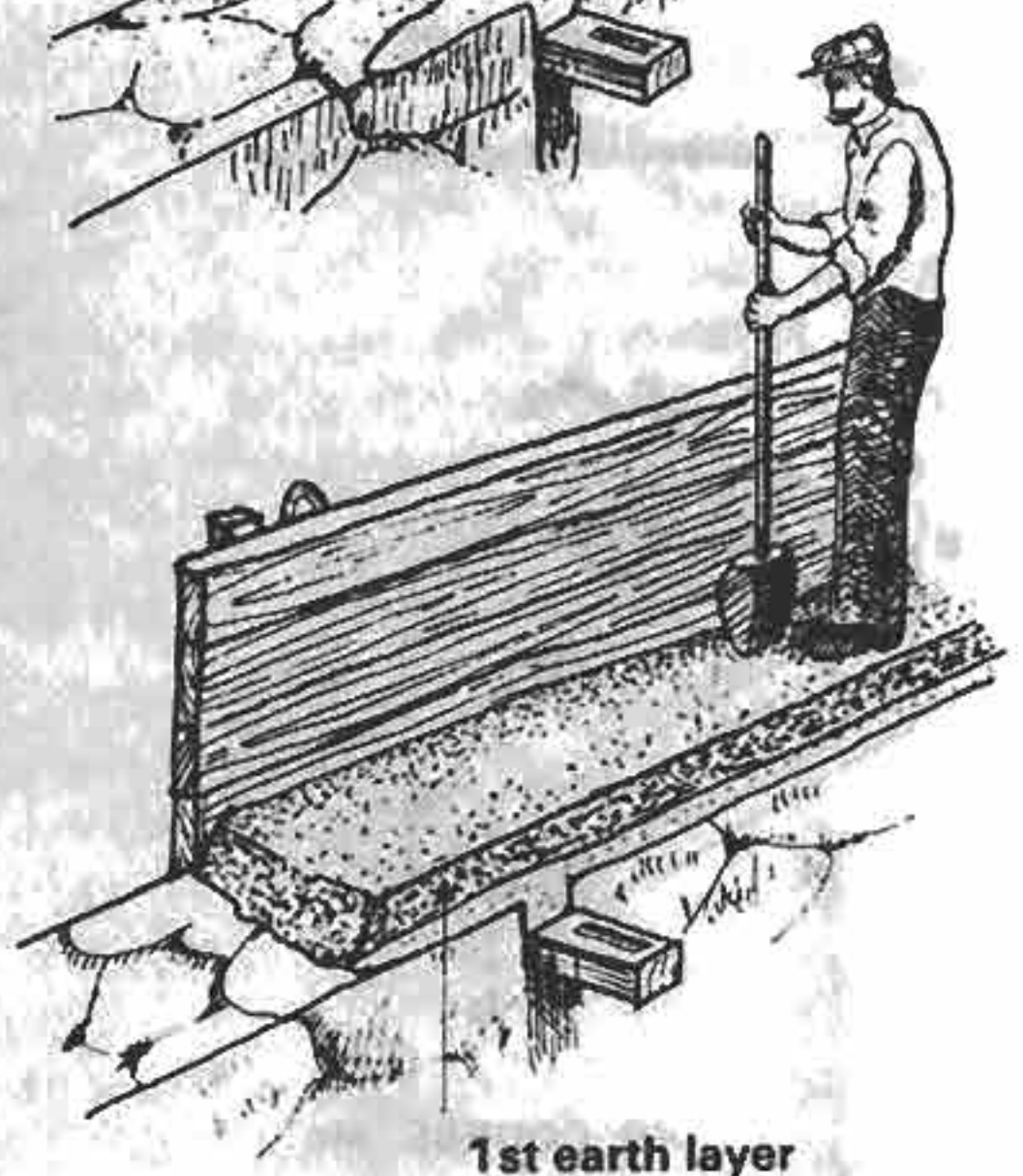

1st earth layer

d

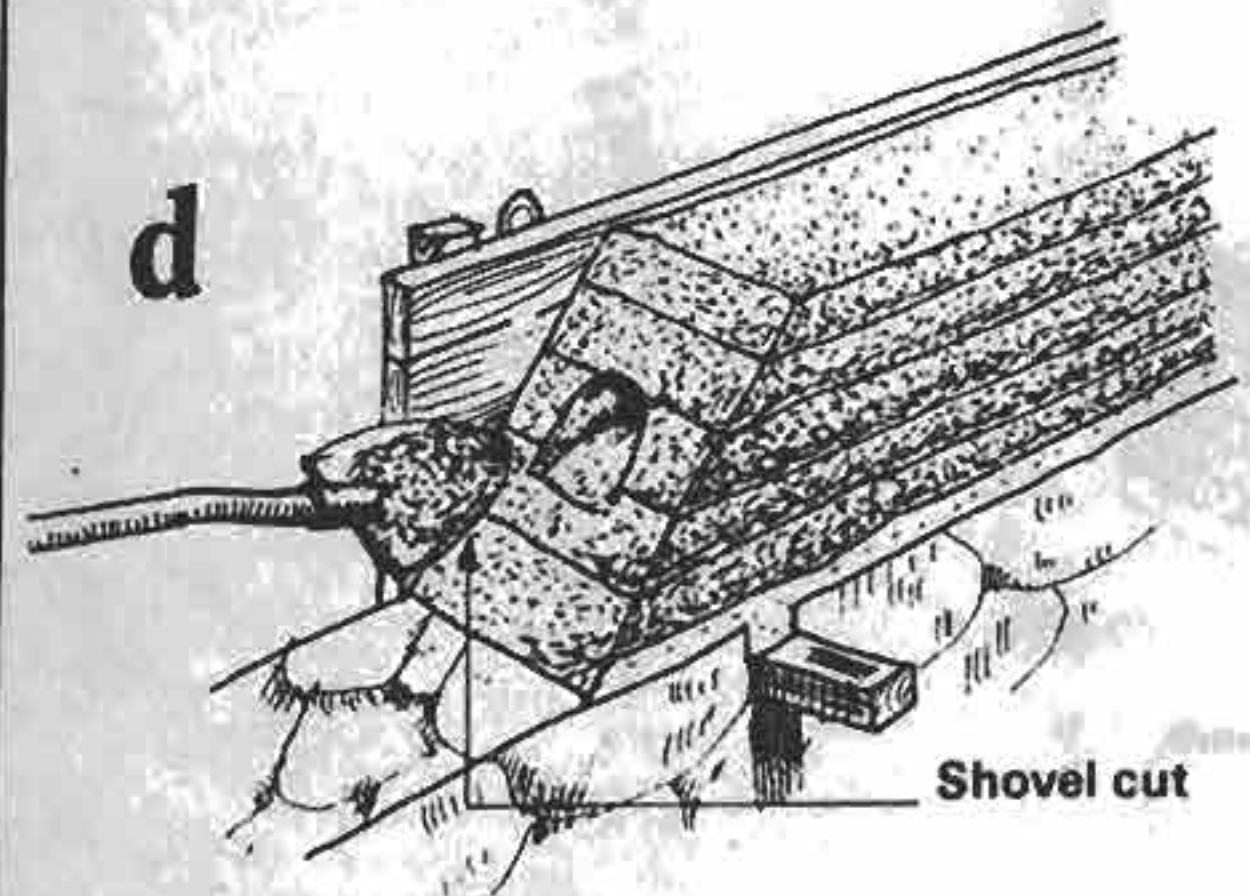

Shovel cut

e

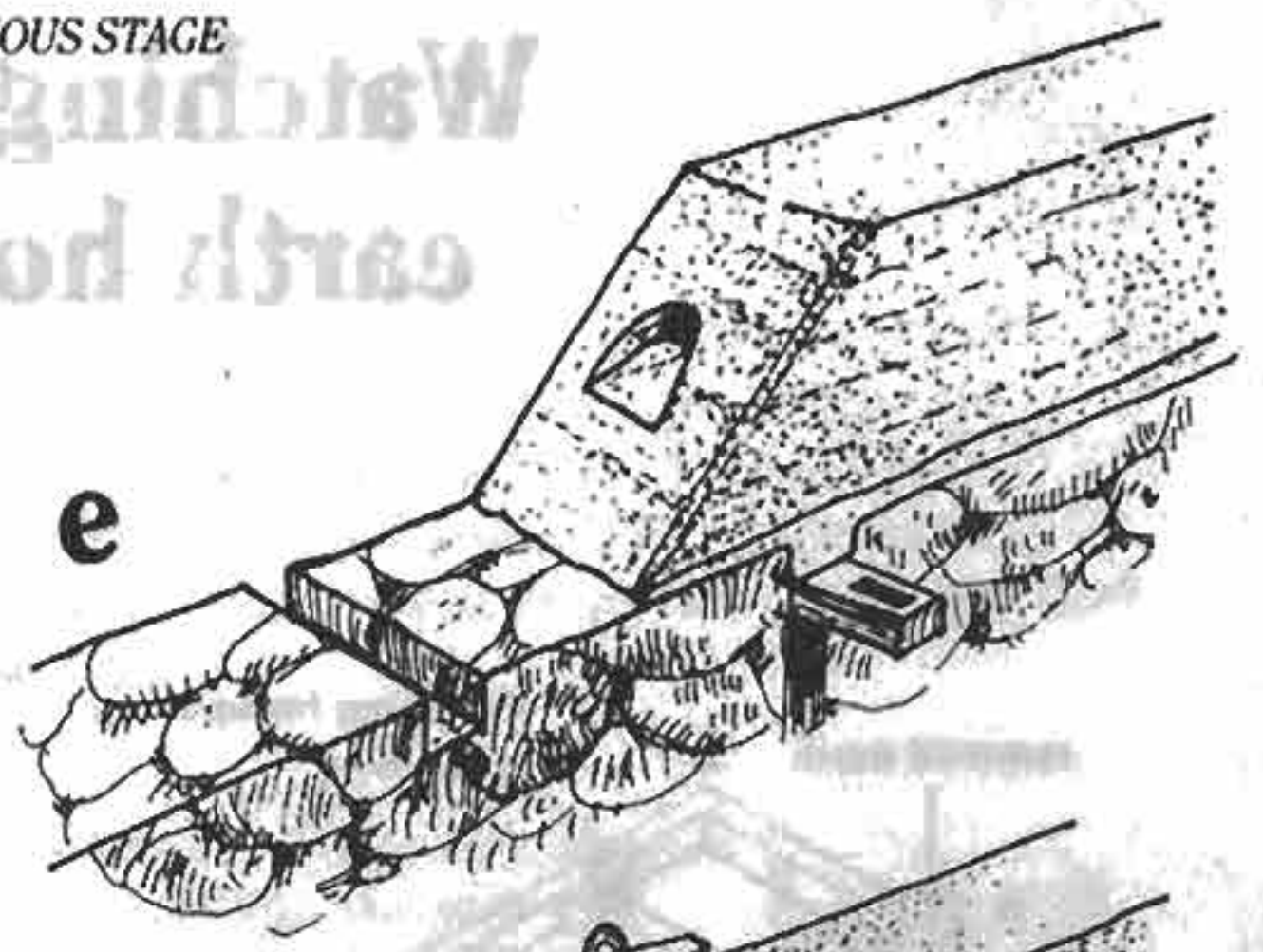

f

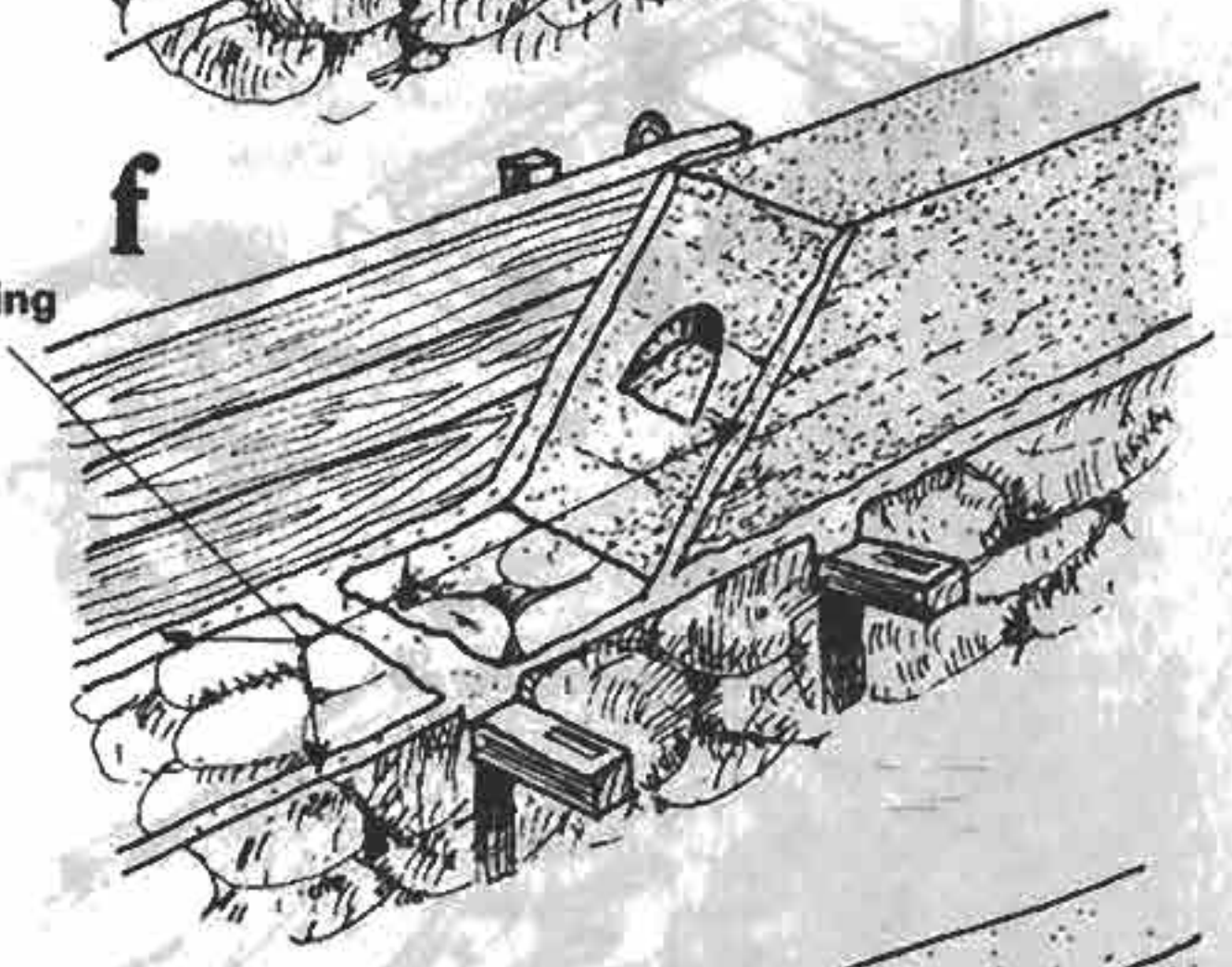

g

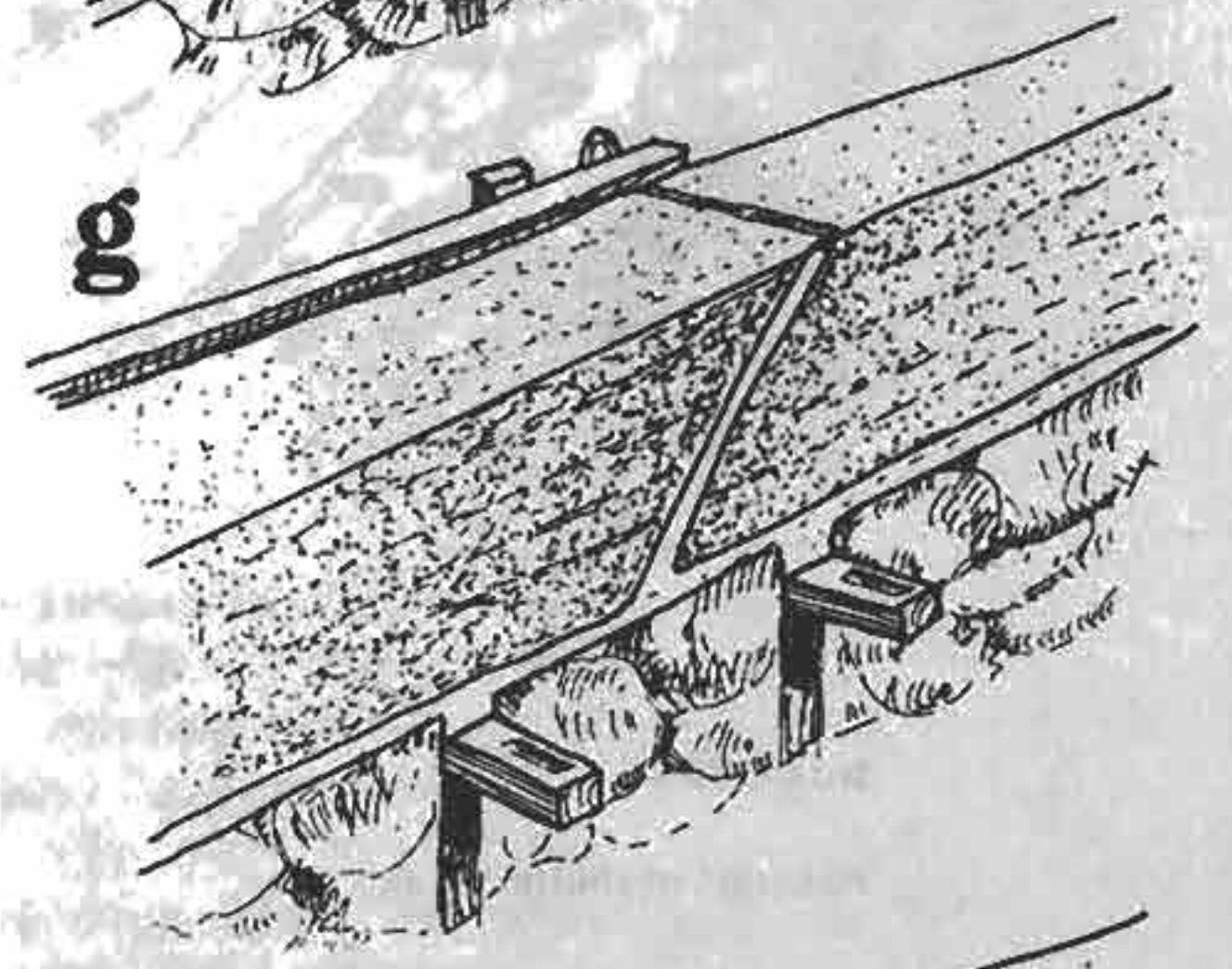

h

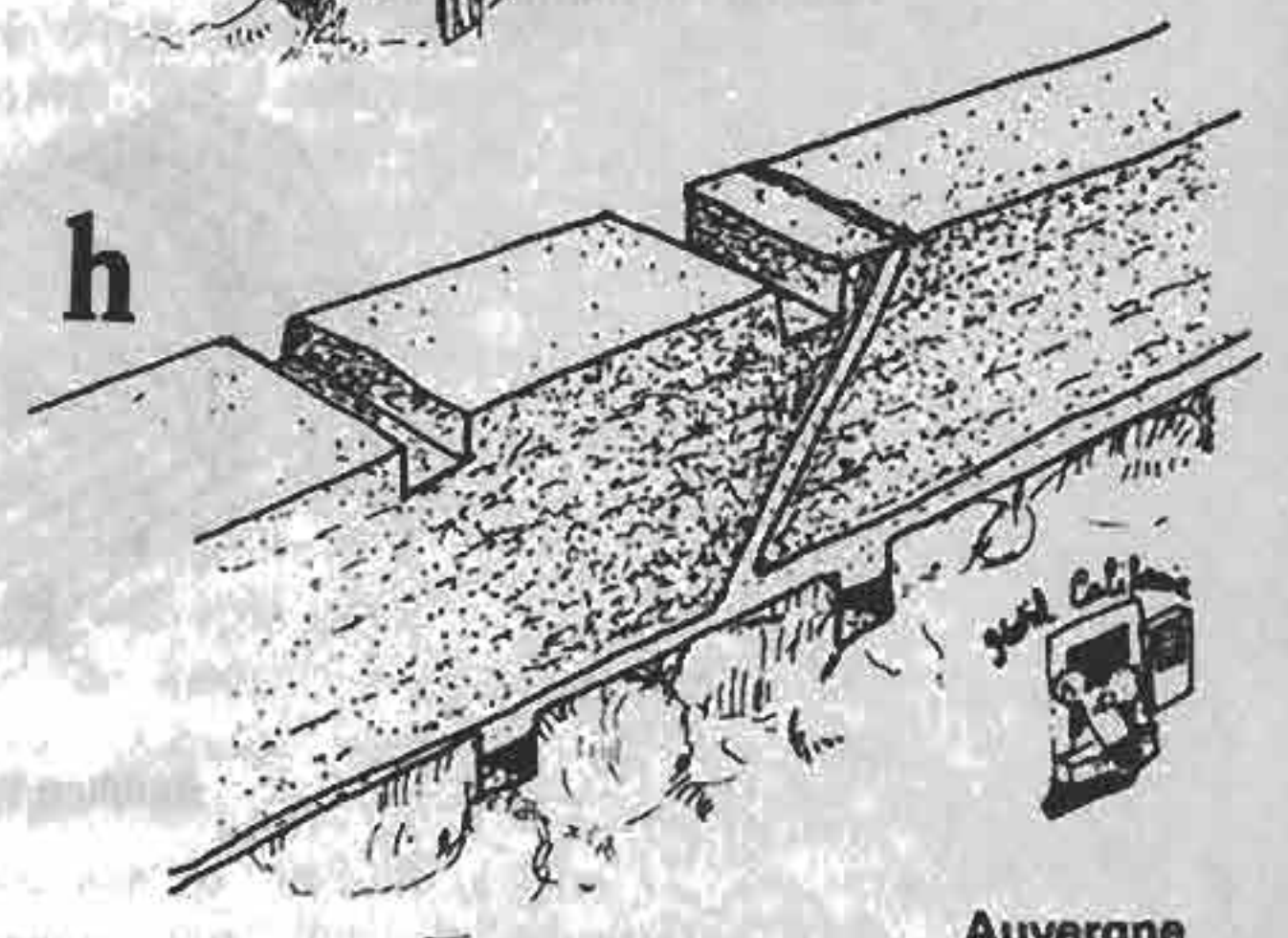

Auvergne

BUILDING THE WALLS

Methods used in the Auvergne and Lyonnais regions (France)

To build the walls (fig. 17), first the footings have to be leveled and the grooves for the putlocks marked (with black or red stone) at 97 cm centres. Between the putlocks the footings are built up 16 cm higher, bringing them to about 80 cm in height. The formwork is fixed to the freshly built footing starting from one corner of the building. The wedges and the posts are then tightened with rope ties and the end-board is placed against the corner.

- Before pouring the earth, a layer of mortar should be spread, but only round the edge of the shuttering, and a few flat pebbles placed in the grooves for the putlocks. This prevents the first load of earth to be thrown into the shuttering from filling the joints and thus allows a better finish.

- The corner is tamped from within the formwork and from time to time the verticality of the wall is checked with a plumb-line. The earth is carried into the formwork, spread out using one's feet and compacted with a rammer to a thickness of about 8 to 10 cm. Once the earth round the edge of the formwork has been compacted, crisscross strokes ensure that the earth is compacted in all directions. Care must be

taken beneath the rope ties, as here vertical strokes are not possible. As each layer (of 16 cm) is completed, a thin layer of mortar is added to the edge against the end-board in order to strengthen the corner.

Using the rammer. In the Puy-de-Dôme region (France) builders use three types of rammer (fig. 18) as follows: The builders in fact work in teams of three and carry out the following operations several times in succession, thus: (fig. 19)

FIGURE 19:
THE AUVERGNE (FRANCE) METHOD
OF TAMPING, SHOWING THE
ORDER FOLLOWED.

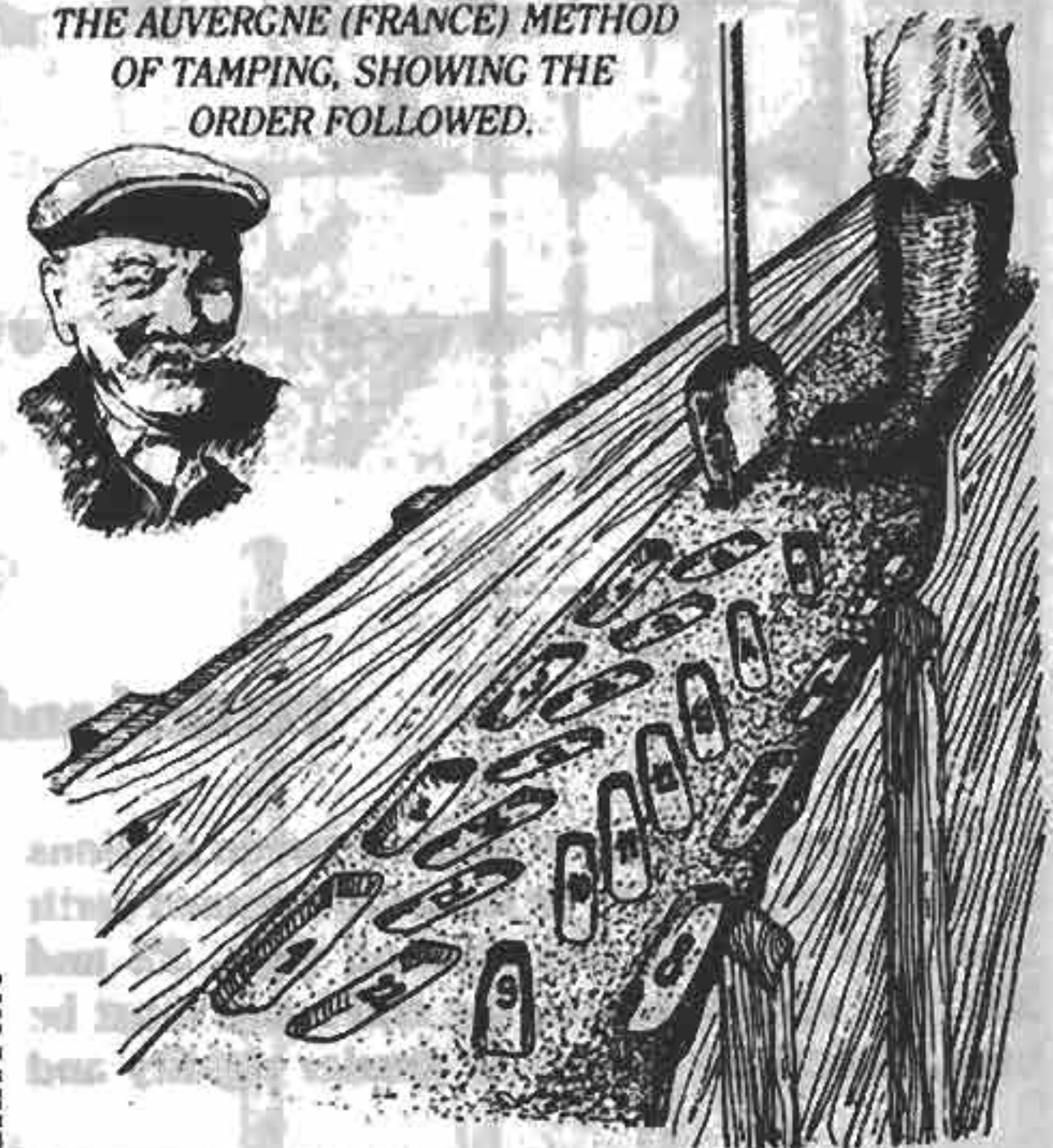

CRA Terre

- longitudinal strokes of the rammer all around the edges of the formwork;
- slanting strokes of the rammer in a "fish-bone" pattern down the middle.

The first builder uses the most pointed rammer and cuts rather than compacts the earth. With each stroke the pointed head of his rammer should touch the layer below, thus ensuring a good bond between layers. The second and third builders then ensure the compaction of the earth.

Once the first layer has been well tamped, the process is repeated layer by layer until the formwork is full. The shuttering should be immediately dismantled.

The formwork is re-erected so that it overlaps the sloping edge of the preceding section, which ensures its stability. Before beginning to fill the formwork, a mortar joint improves the bond with the previously compacted section. The process is repeated all the way round the

FIGURE 18: THE THREE TYPES OF
RAMMER USED IN AUVERGNE (FRANCE)

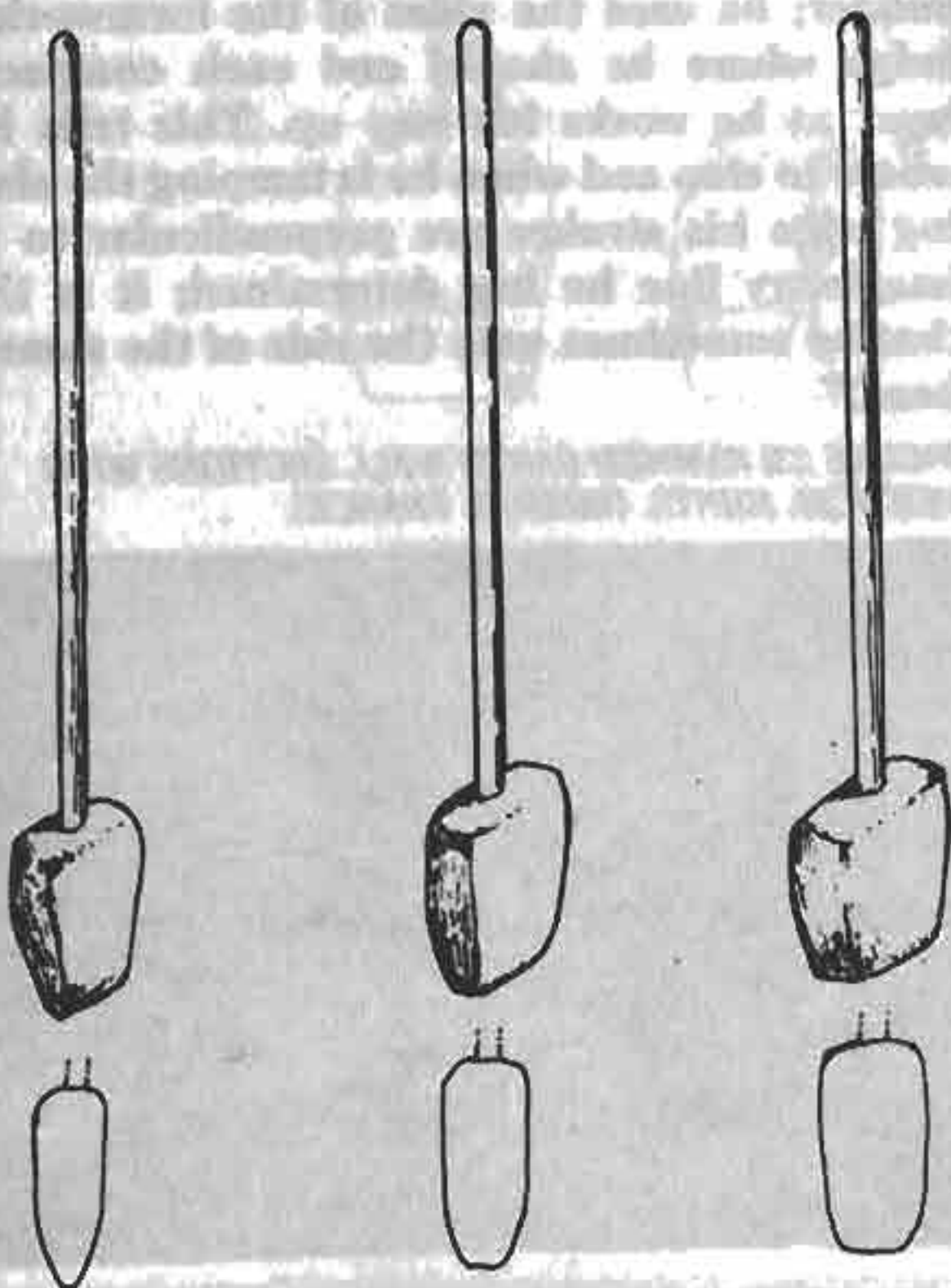

CRA Terre from Maison Paysanne de France n° 3, 1977

house. The first course is then sufficiently strong to be able to bear the weight of the builders and for another course to be added.

FIGURE 21: RAMMED EARTH SECTIONS WITH SLANTING JOINTS

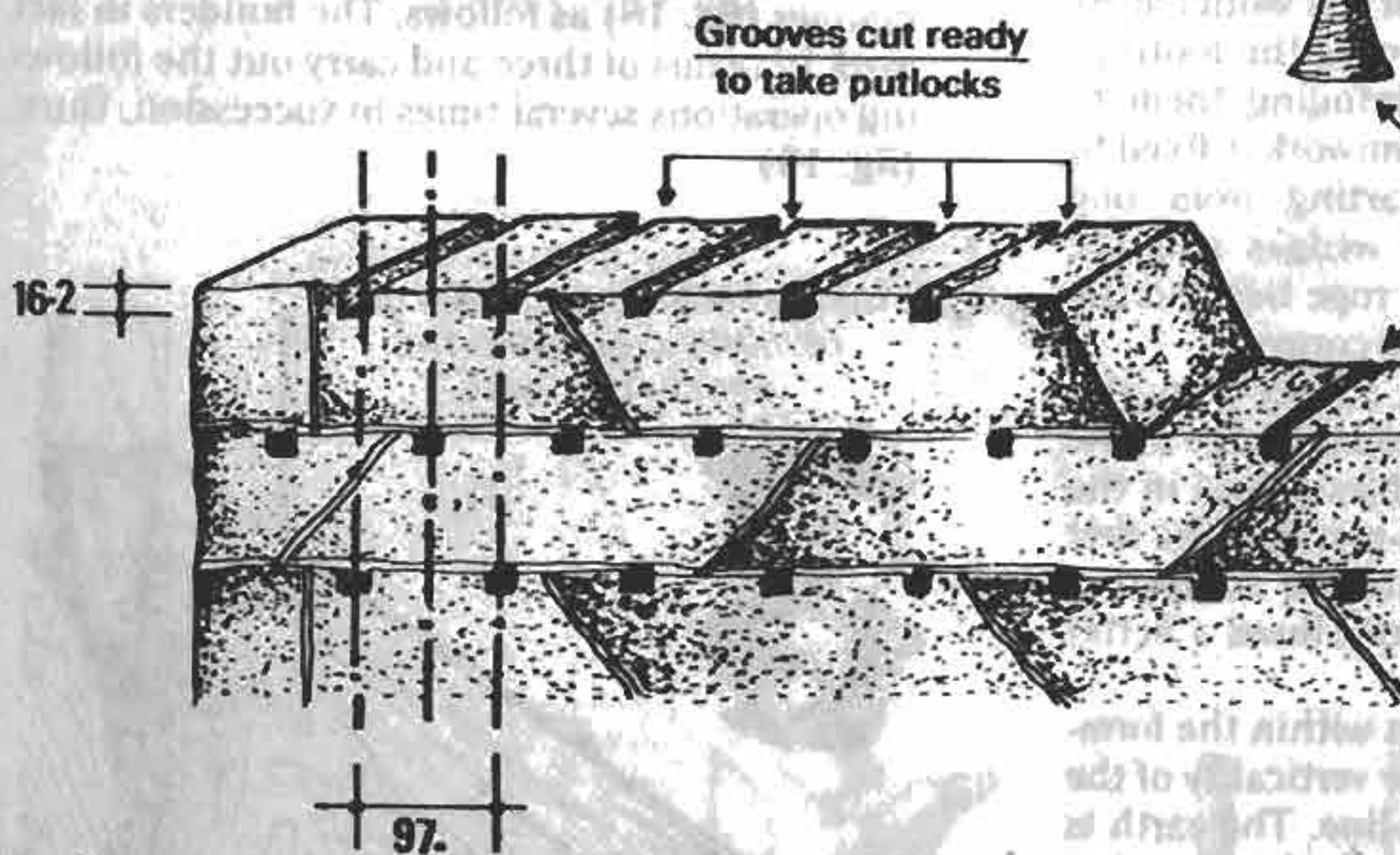

Grooves are cut in the previous course to take the transverse ties and staggered to avoid the formation of vertical cracks (fig. 21).

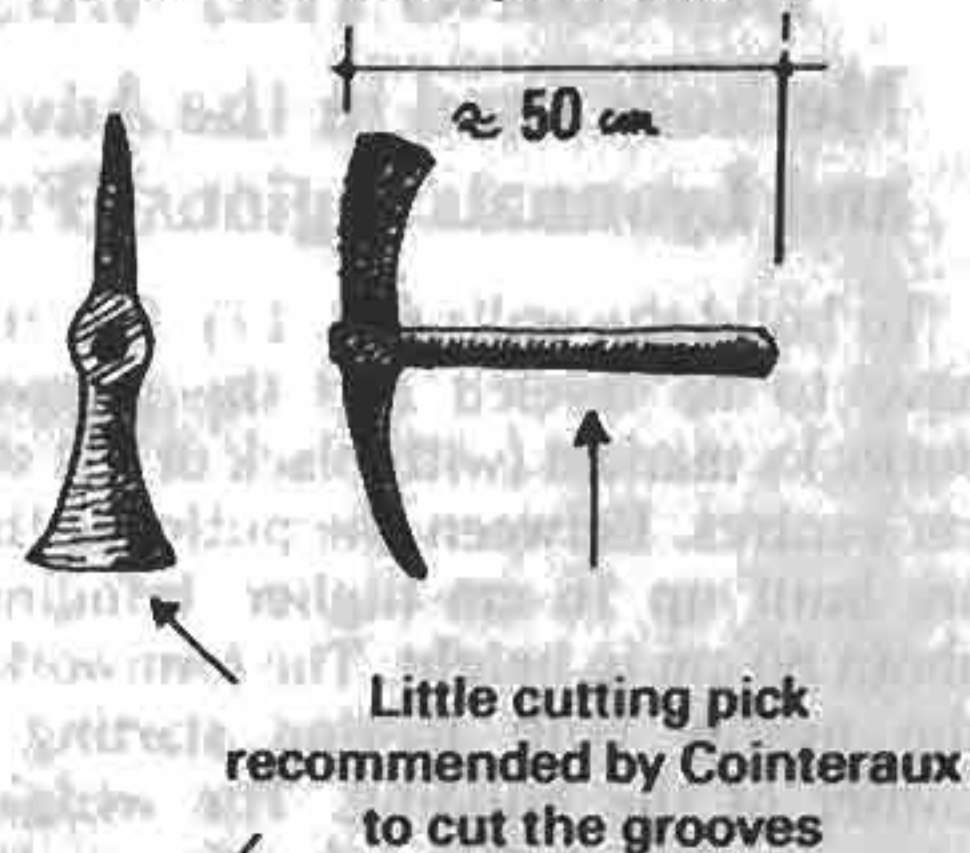

Vertical and slanting joints

There are two types of joints between sections of the same course to be found in rammed earth buildings: vertical and slanting (figs. 22 and 23). For vertical joints, the end-board must be used, giving the formwork greater rigidity and

the volume of each section of wall is reduced. Goiffon has described how the slanting joints were compacted thus:

“(...) Each section therefore ends in a slope which is shaped thanks to the skill of the builder; he uses the sides of the formwork to judge where he should end each compacted layer as he works his way up. This tells him where to stop and when he is tamping the slanting edge his strokes are perpendicular to the imaginary line he has determined; it is then that he sometimes uses the side of the rammer head.”

FIGURE 23: RAMMED EARTH WALL SECTIONS WITH VERTICAL JOINTS. (BRESSE, FRANCE).



FIGURE 22

enabling a greater volume of wall to be built in one go. Slanting joints, usually at an angle of 45°, theoretically improve the bond between two adjacent sections. They are made by tamping on a slant; the formwork no longer requires end-boards and is therefore easier to erect, but tamping a sloping surface is not very easy and



FIGURE 20: Illustration of how the rural inhabitants of the Lyonnais region (France) used to make a wooden rammer. A — a piece of hard wood is cut and squared to a thickness of 13 cms, a length of 27 cms and a width of 16 cms. B — a line is drawn around it 16.2 cms below the top. C — the other sides of the piece of wood are divided in two and lines extended to split them equally. D — two lines are drawn 4 cms apart below the central one. E — the excess wood is chiseled away from the line drawn around forming a sort of corner. F — a compass is used to trace a circle 10.8 cms in diameter on the top. G — the upper corners are cut in such a way as to link the circle on the top to the line drawn around the block, and the corners are rounded off. H — the wood is polished, particularly at the bottom, and a hole 5.4 cms deep is made to take the handle, the overall length of the tamp being approximately 1.3 m.

How to make a rammer

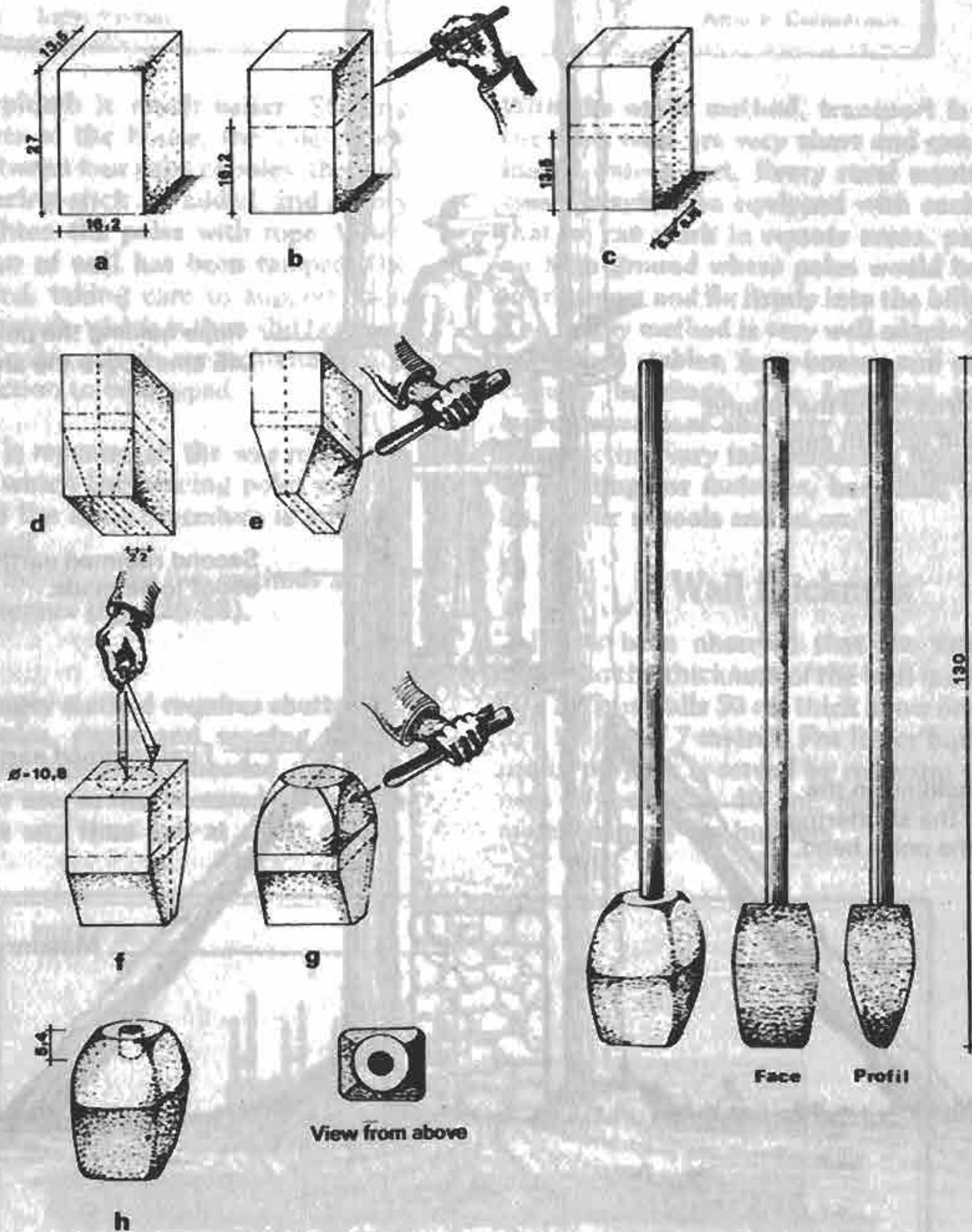

The "Bugey" method (fig. 24)

In the Bugey region (Ain, France) the formwork is not held in place by putlocks but is directly supported from the ground using long vertical poles along each side of the wall.

Once the footing is complete, wooden poles 8 cm in diameter are dug in vertically at 1m intervals on both sides of the wall tracing. When this bracing is in place, handling the formwork and

FIGURE 24:

Bugey method

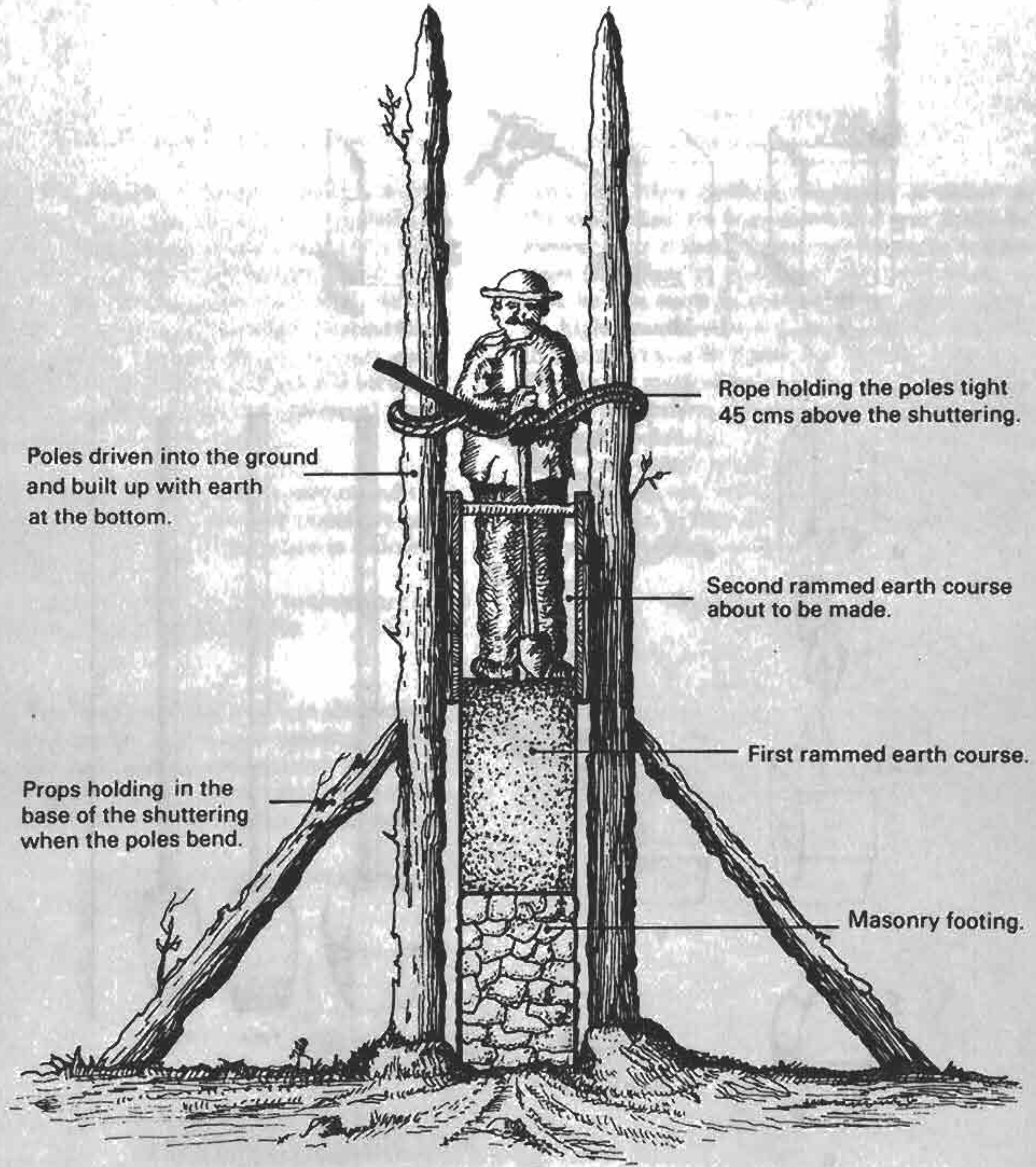

Poles driven into the ground and built up with earth at the bottom.

Rope holding the poles tight 45 cms above the shuttering.

Second rammed earth course about to be made.

First rammed earth course.

Props holding in the base of the shuttering when the poles bend.

Masonry footing.



FIGURE 25:

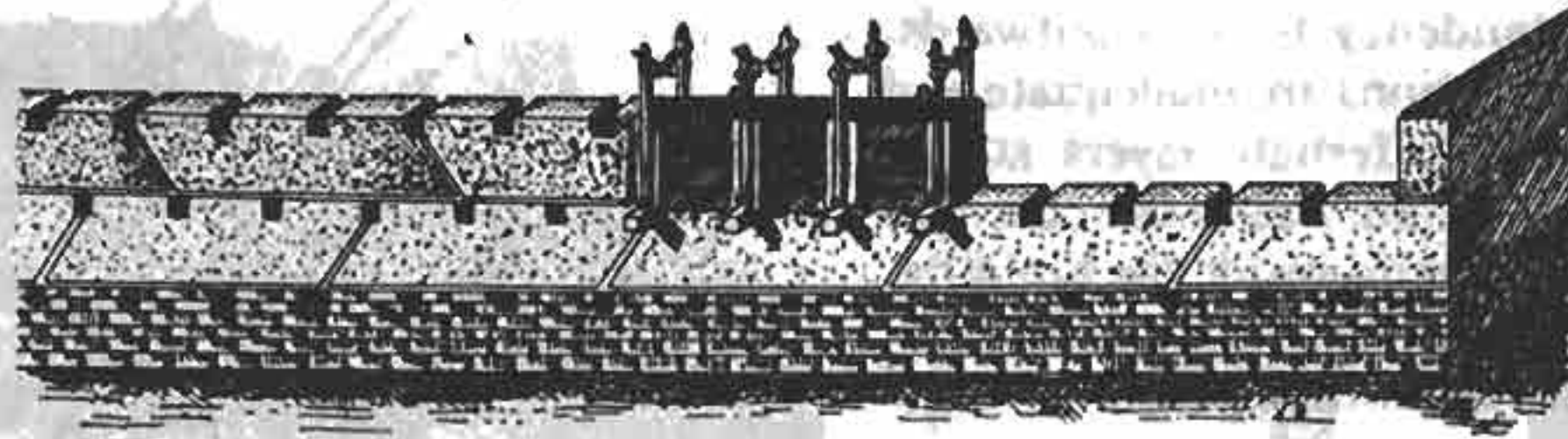

Lyon method

After F. Cointeraux.

checking the plumb is much easier. Starting from one corner of the house, the side-panels are inserted between four pairs of poles; the end-boards and spacing-stick are added; and it only remains to tighten the poles with rope. When the first section of wall has been tamped, the ropes are untied, taking care to support each side of the formwork, which is then slid between the next set of poles, which are tightened ready for the next section to be tamped.

The process is repeated all the way round the building after which the bracing poles are carried inside and the same procedure is followed for the inner wall.

The relative merits of the two methods are set out by F. Cointeraux (figs. 25-26).

“(...) The Bugey method requires shuttering, rough-hewn poles, ropes and spacing sticks; that is the only equipment needed and it is always ready for use, so that rammed earth walls can be built at any time and at short notice.

With the other method, transport is easier as the tools used are very short and can easily be loaded onto a cart. Every rural master-builder must therefore be equipped with such tools so that he can work in remote areas, particularly on high ground where poles would be difficult to transport and fix firmly into the hilly ground! The Bugey method is very well adapted to building barns, stables, farm-houses and other agricultural buildings. The Lyonnais method is more convenient and very commonly used for constructing very tall, imposing houses, either as dwellings or factories, hospitals, presbyteries, public schools and so on.”

Wall thickness

It has been observed that the ratio of the height to the thickness of the wall is a little over 10 : 1. Thus walls 50 cm thick allow one to build to a height of 7 metres. For lower buildings no useful purpose is served by reducing the thickness to less than 40 cm, because this would merely hamper the builders.

FIGURE 26:

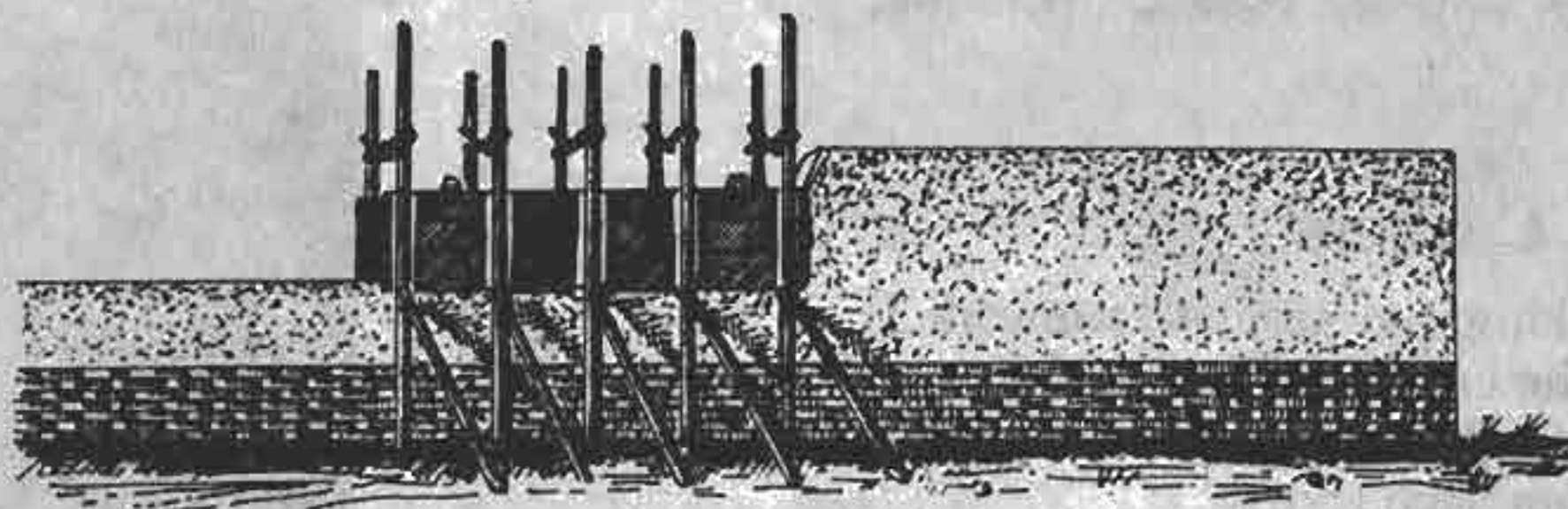

After F. Cointeraux.

Ring or tie beams

The walls of houses which have little or no ring-beam have a tendency to lean outwards, especially if the foundations are inadequate and if interlocking of the alternate layers at the corners has been neglected. Hence the common practice of adding tie-beams inside the building. These tie-beams consist of two metallic X's linked by a threaded rod which keeps the walls parallel.

Effective reinforcement can be achieved by building in horizontal wooden beams 15 cm in diameter which connect in the corners (fig. 27).



FIGURE 27: WOODEN RING-BEAM WITHIN THE RAMMED EARTH WALL

CRATerre

Timber beams are incorporated into the wall having been first dipped in a lime and sand mortar in the case of pine, or in plaster or earth in the case of oak.

"If pine is used we know from experience that a lime and sand mortar burns oak and nourishes pine: for this reason plaster masonry must be used - or if this is not possible, a good earth mortar - for any oak beams." (Goiffon, ref.17).

Corners

Generally speaking, no special formwork is needed to build the corners and it is often considered sufficient to alternate the sections at the ends of the walls on each course.

Overcoming the greater risk of erosion at corners has always posed some problems, however, and has led to various methods of reinforcing:

26 - placing a triangular fillet of wood in the

external corner of the formwork which removes the vulnerable right angle (fig. 28);

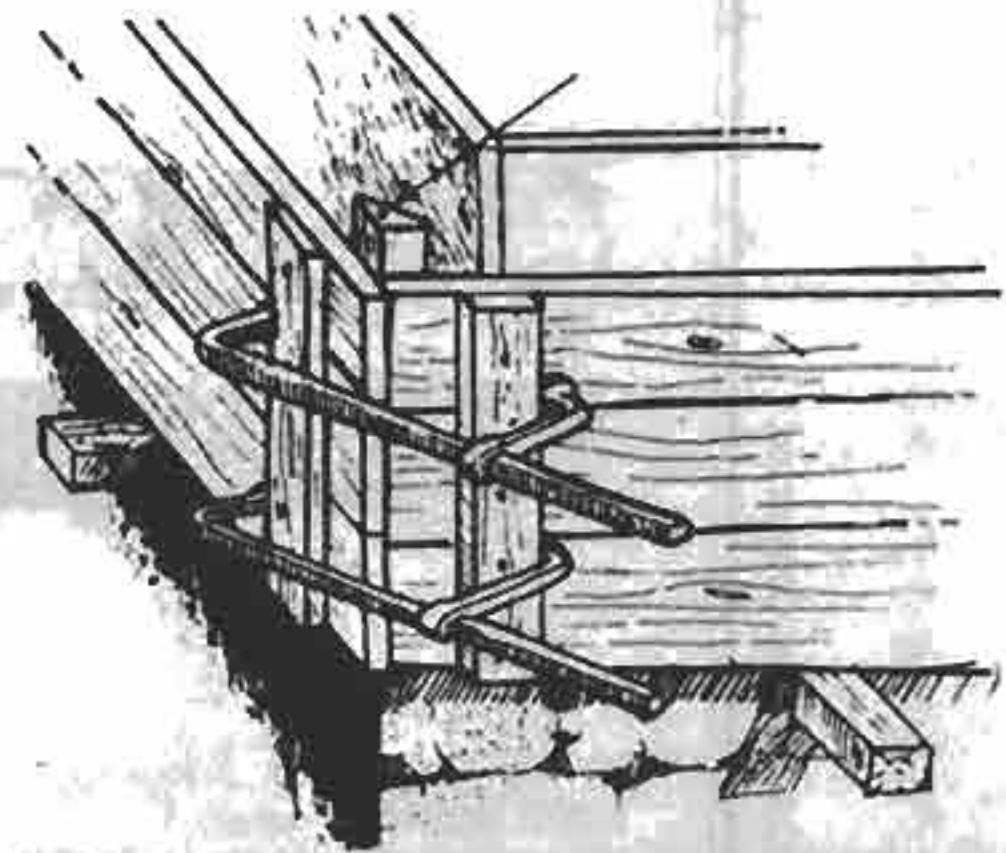

Pierre Bonneville

FIGURE 28: SHAMFERED CORNER ACHIEVED BY PLACING A WOODEN TRIANGLE IN THE EXTERNAL CORNER OF THE FORMWORK.

- pouring a thin strip of lime mortar on either side of the corner between each 10 cm tamped layer (fig. 29);

FIGURE 29: REINFORCING THE CORNER WITH A THIN STRIP OF LIME MORTAR (ISERE, FRANCE).

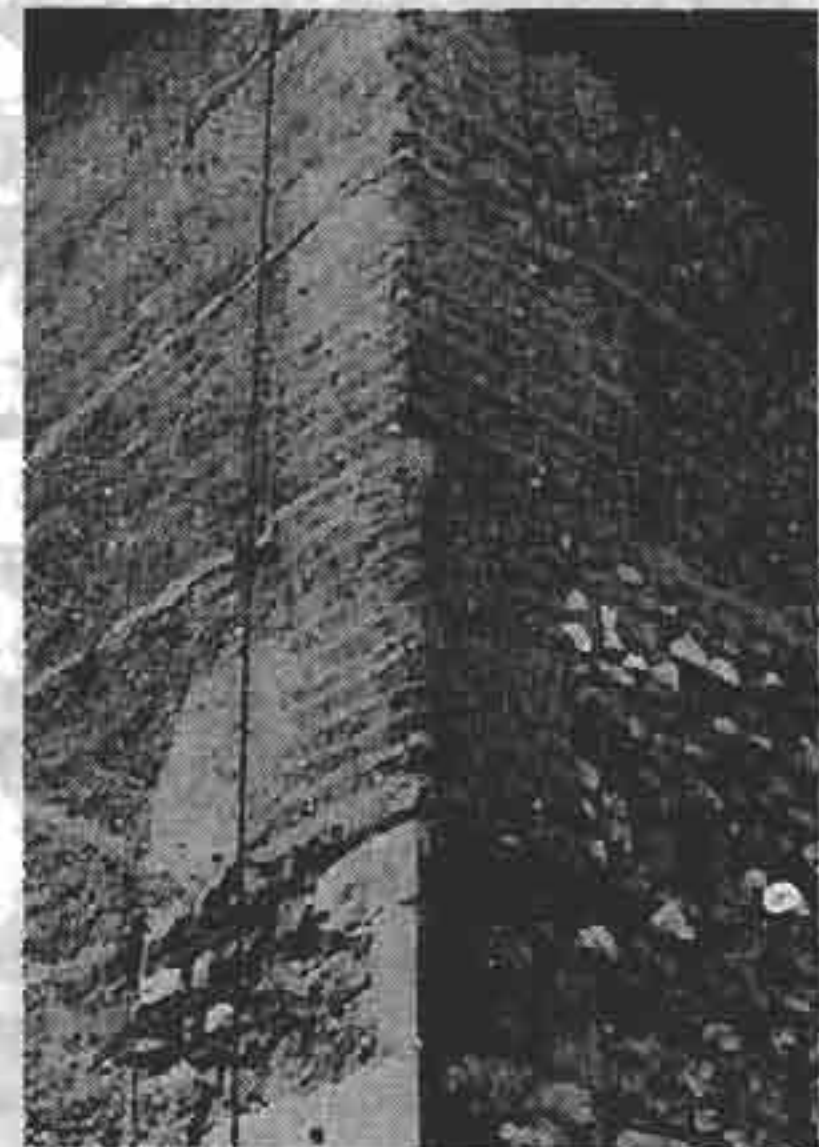

CRATerre

- the corner is also sometimes reinforced with brick, stone or other masonry (fig. 30).

FIGURE 30: REINFORCING THE CORNER WITH "FLAGS" (ISERE, FRANCE).



CRATerre

Openings

Whenever an opening is required, two end-boards are placed in the shuttering. For door-

ways, they are angled slightly further apart towards the inside, to make opening the door easier.

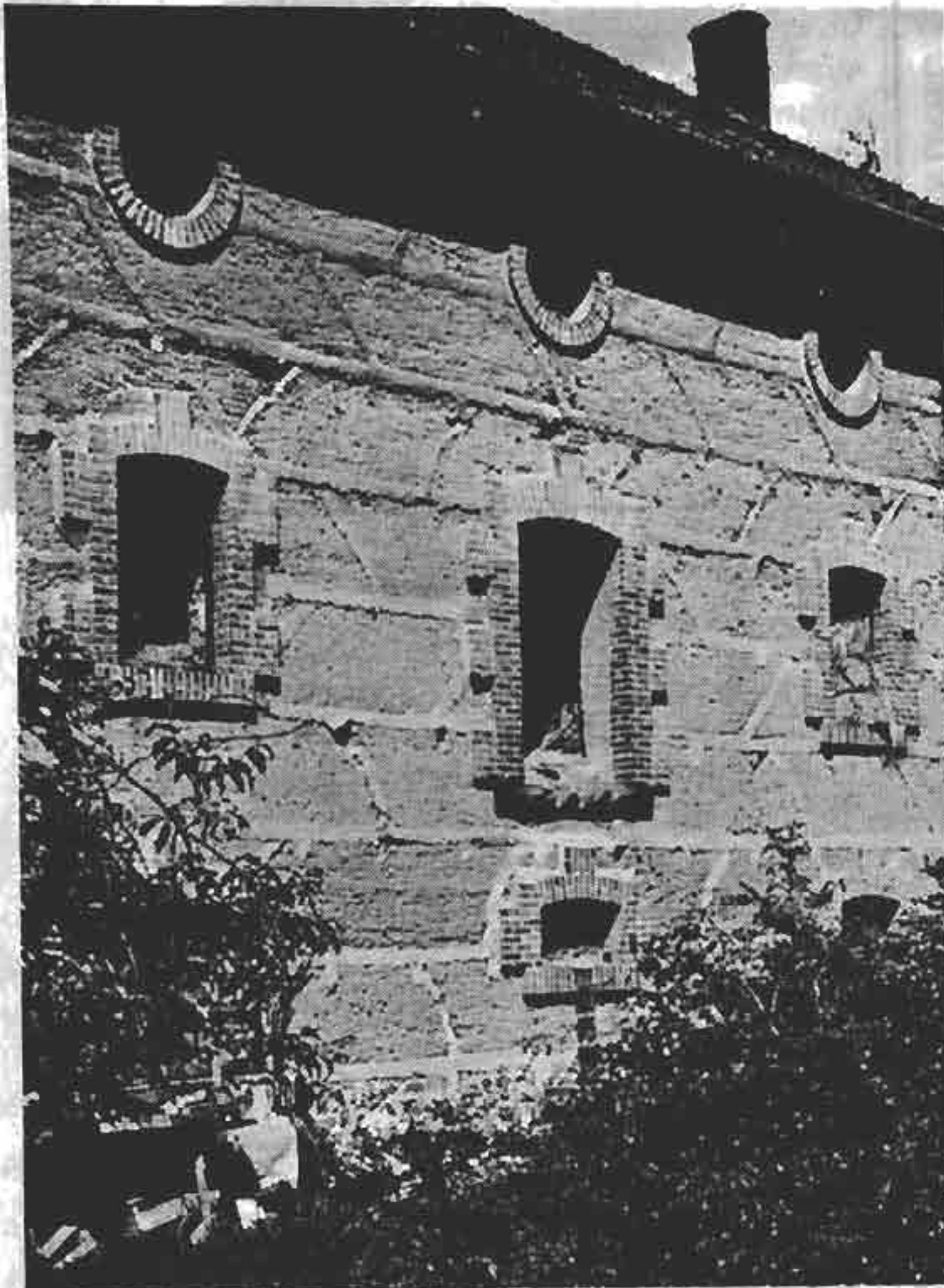
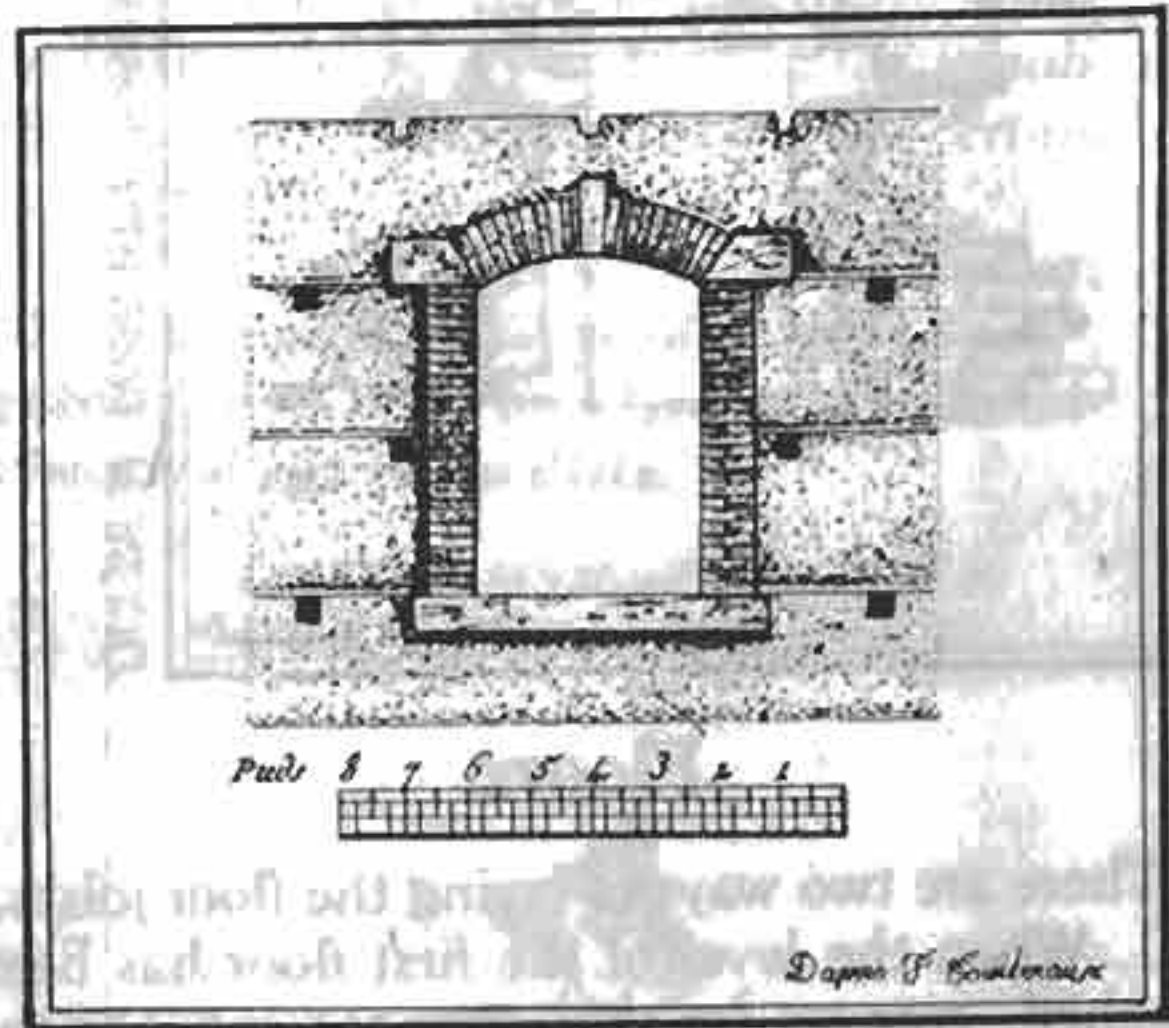

FIGURE 33: AUVERGNE (FRANCE)



FIGURES 31/32: DOOR AND WINDOW FRAMES ARE OFTEN MADE OF BRICK, STONE OR WOOD. OCCASIONALLY FRAMES PLACED IN THE FORMWORK AND WELL-BRACED FORMED A "RESERVED SPACE" DURING TAMPING AND WERE LATER LEFT IN PLACE.

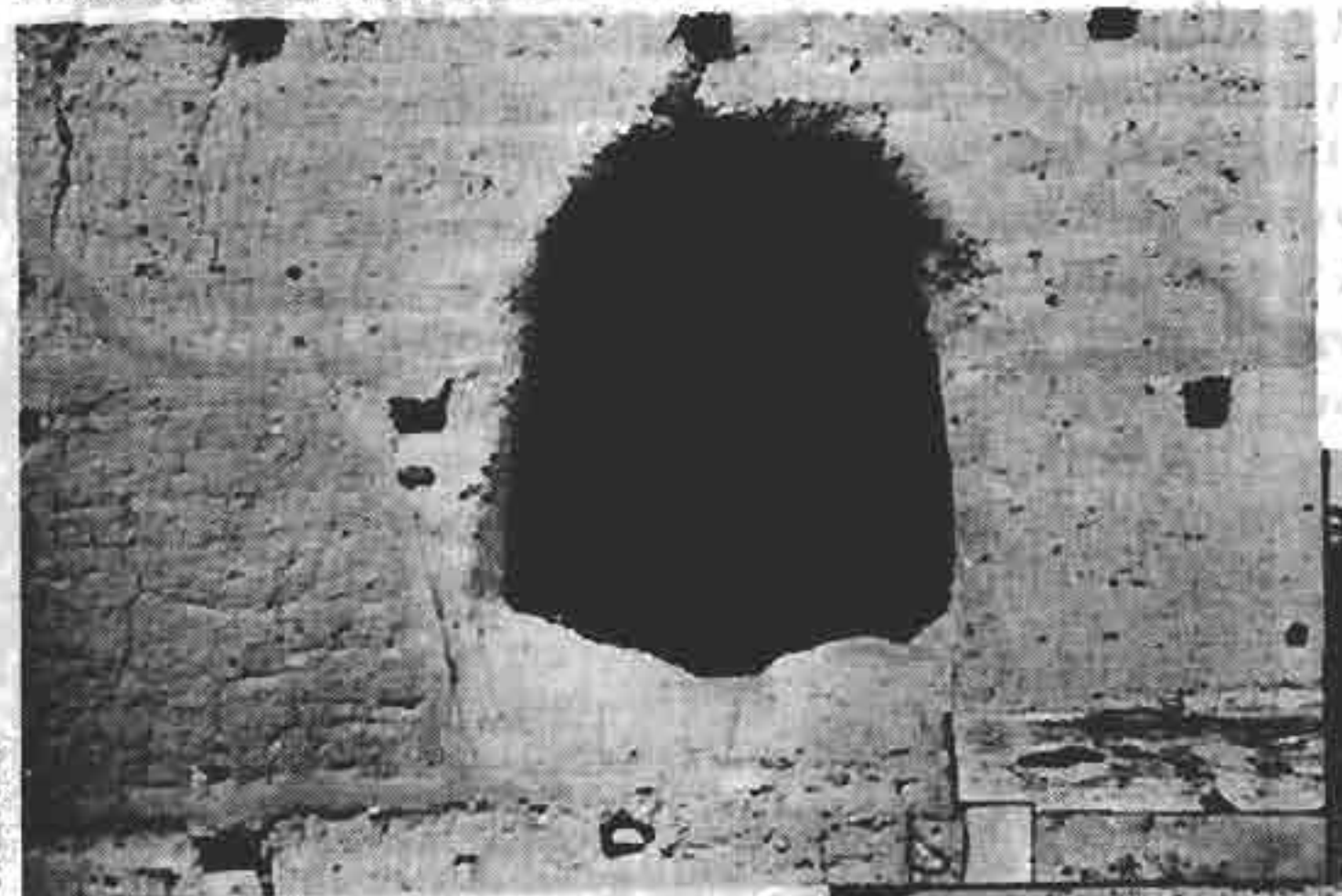
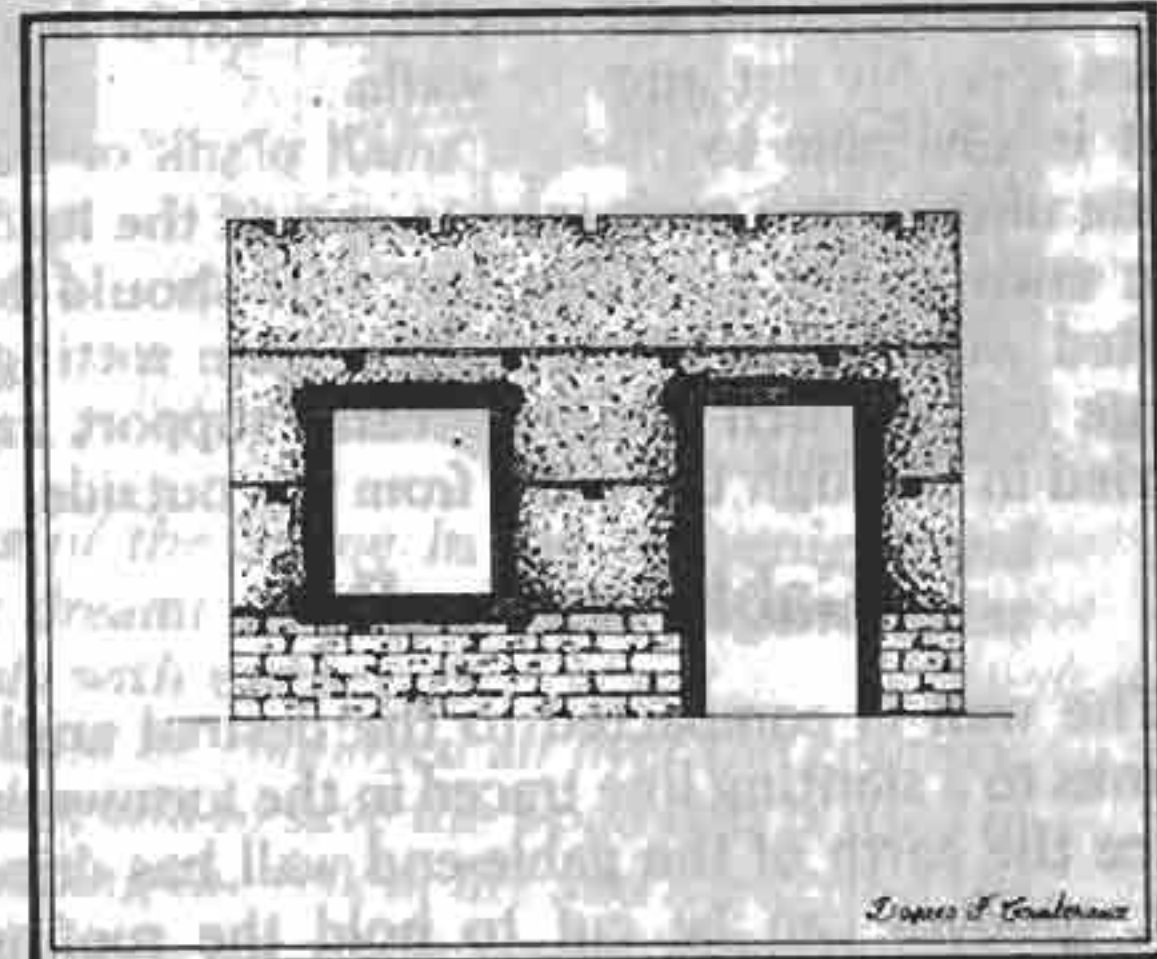
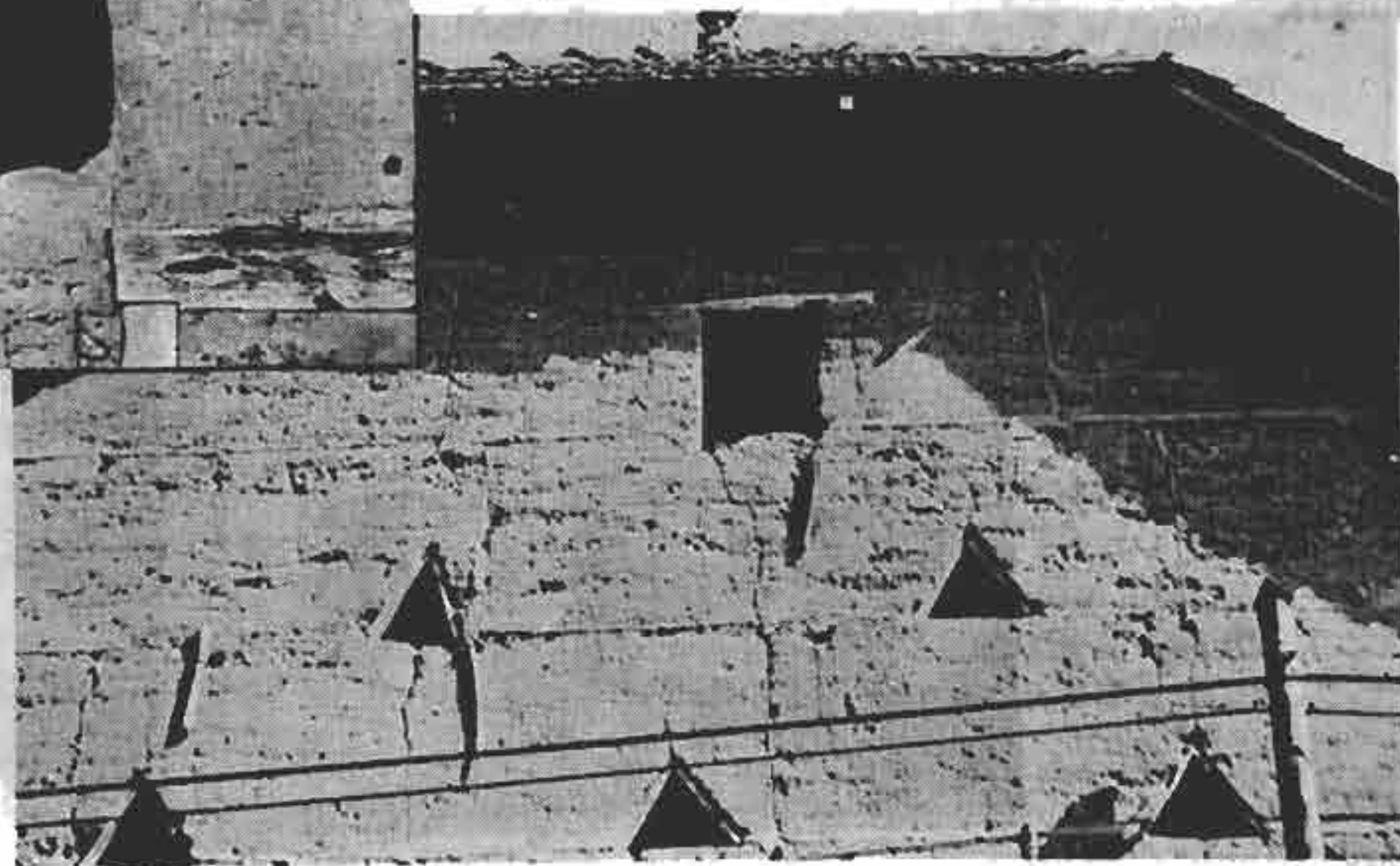

FIGURE 36: THE OPENING FOR A HAY LOFT IS OFTEN CUT DIRECTLY INTO THE WALL WITHOUT LINTELS OR SIDE-SUPPORTS.

FIGURE 37: SMALL TRIANGULAR OPENINGS PROVIDE VENTILATION FOR BARN.



CRATerre from Cointeraux

CRATerre from Cointeraux

CRATerre

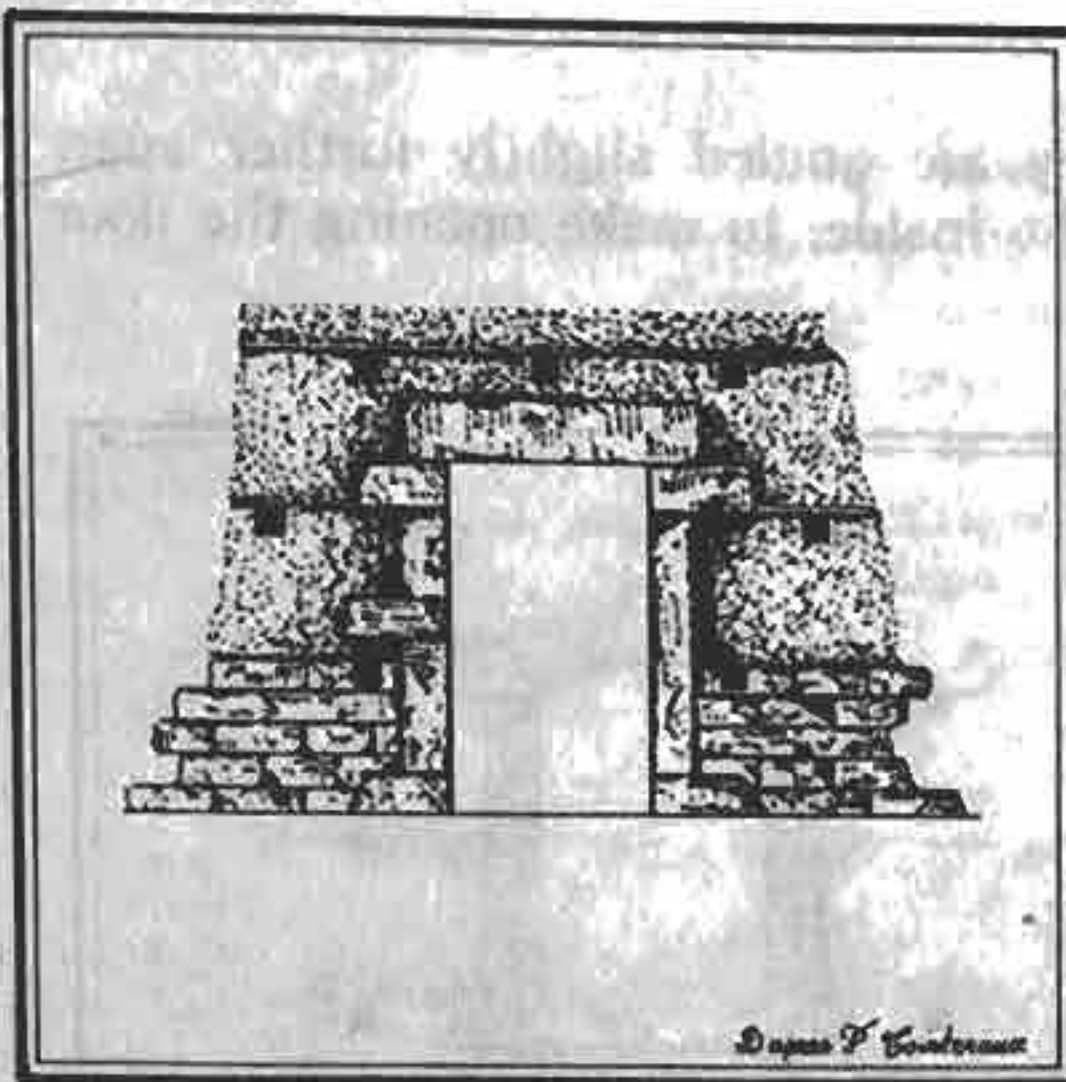
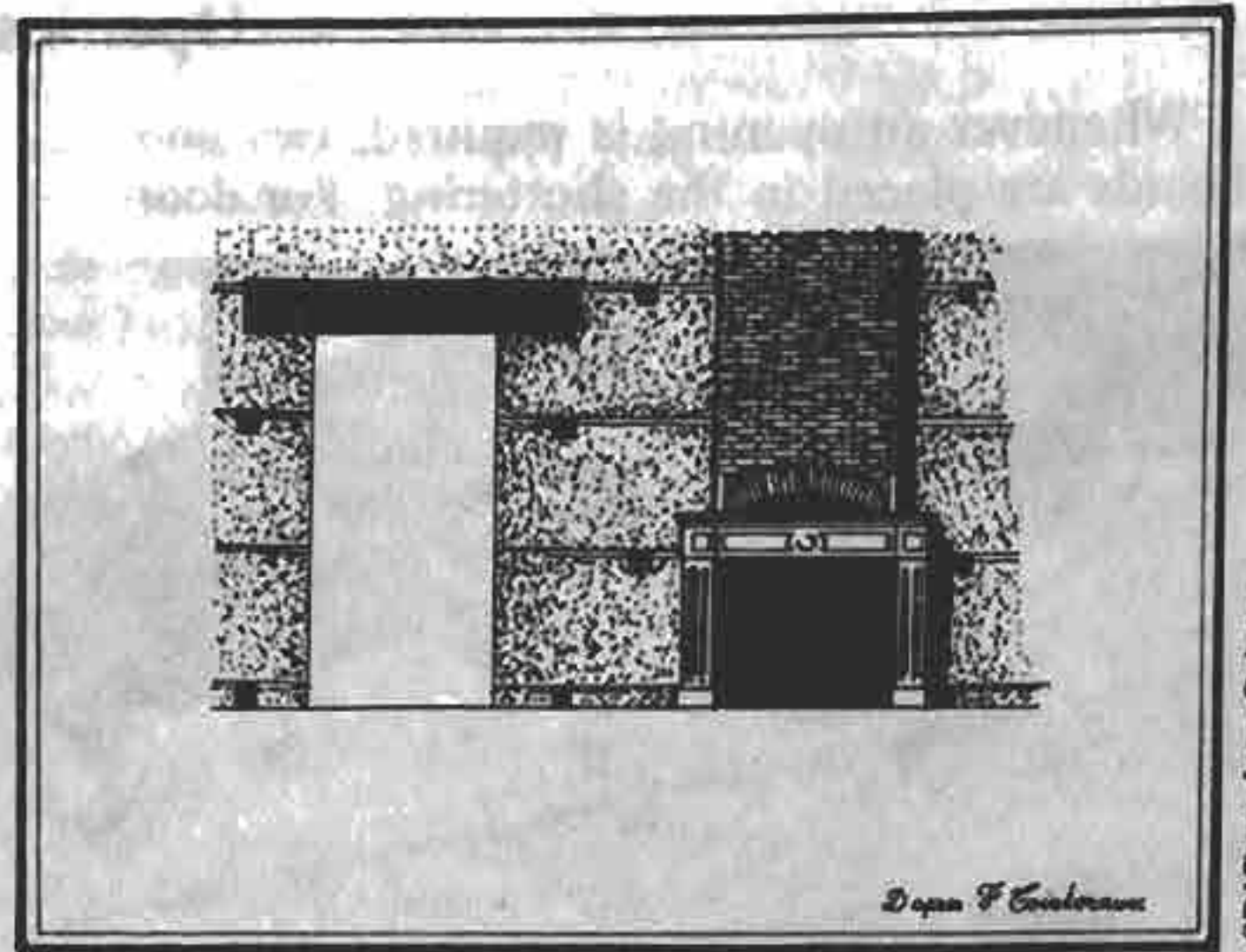

FIGURE 34: DOOR WITH MASONRY FRAME.

FIGURE 35: DOOR WITH NO MASONRY FRAME —
WOODEN LINTEL.

Floors

There are two ways of laying the floor joists.

1. When the level of the first floor has been reached, grooves for the joists are cut into the top of the wall. The joists should be placed sufficiently low in the wall to allow room for the putlocks and the lower overlapping part of the shuttering. The floor is laid and the next floor is built up in the usual way.

2. The walls are raised to the top of the building and the joists are inserted afterwards in holes specially cut into the walls.

It is advisable to place a small plank or flat stone underneath each joist to spread the load. The ends of the joists in the wall should be coated with tar to prevent them from rotting. Large joists which require greater support are carried in through the walls from the outside.

Gable-end walls

The wall is compacted to the desired angle thanks to a slanting line traced in the formwork. Once the earth of the gable-end wall has dried out, grooves can be cut to hold the roofing timbers.

Roofing

Generally speaking, the design of rammed earth houses aims to economize on roof timbers. Hence the gable-end walls and internal walls which replace all the roof trusses (fig. 38).

No particular roofing material is specifically used for rammed earth houses: in France, one finds thatched roofs in Brittany and the Dauphiné region, slate roofs in Brittany and flat or Roman tiles in the Dauphiné and Auvergne regions.

One might expect large overhangs on rammed earth houses. In fact, the roof overhangs are never very wide (about 1 metre in the Dauphiné region). If they are wider, there is generally some specific reason for this other than protecting the wall: for example in farmhouses to shelter a drier or hay-carts which there has been no time to unload. Keeping the roof in good condition is nonetheless important in ensuring the durability of a rammed earth house. Water infiltration at the top of the walls rapidly brings about the complete collapse of the building.

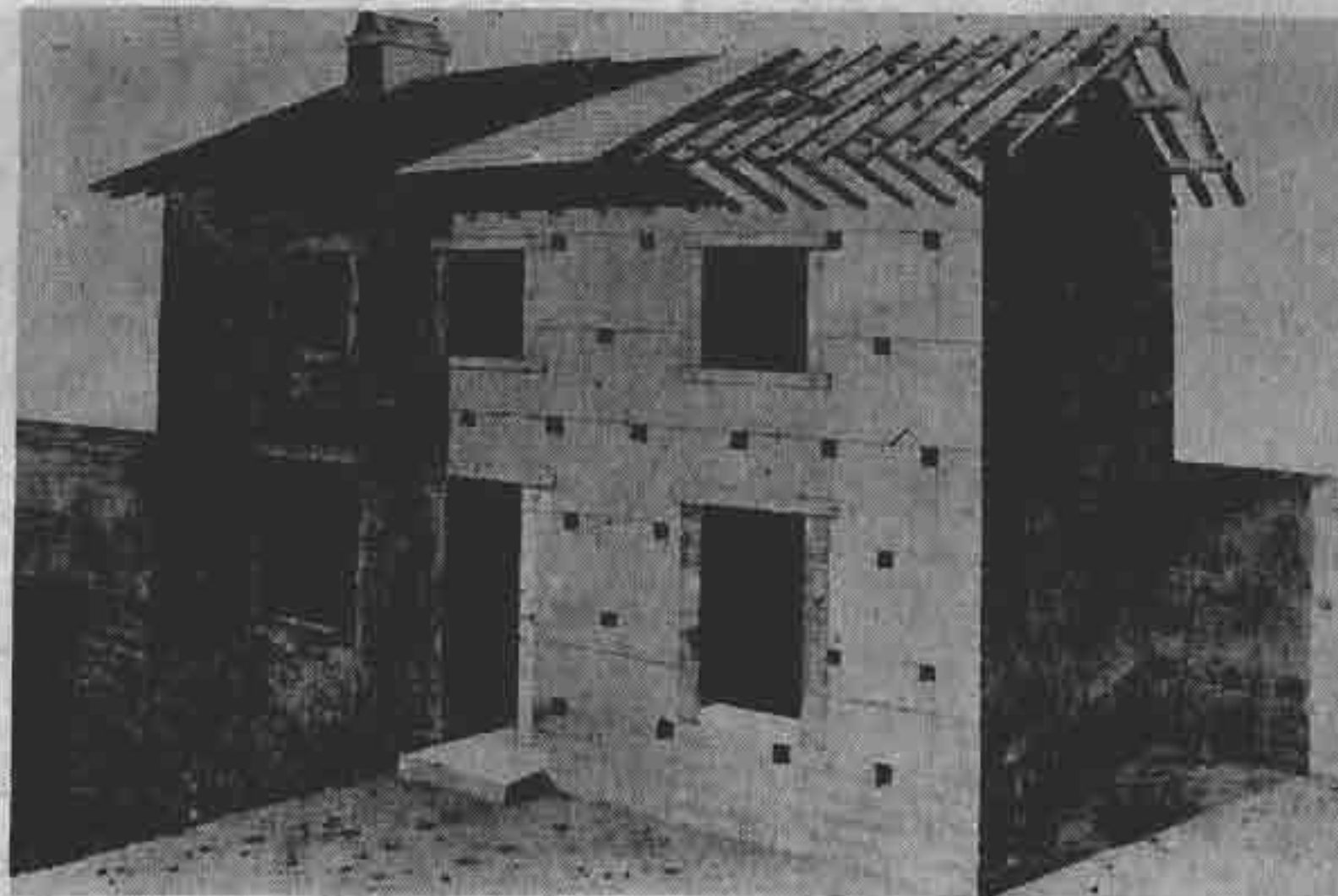
FIGURE 38:
ENGRAVING FROM
"THE ART OF BUILDING",
(RONDELET).

"A house built in rammed earth according to the principles that we have just stated, will last as long as one that has been built in sound masonry. Examples 30 feet high above the footing which have stood for 200 years are still to be found and in good condition, having required no more extensive or frequent repair than any other type of building. In short, rammed earth construction is essentially durable and can be counted among those construction methods which are best able to

protect us from the misfortunes against which we implore the help of Architecture. A rammed earth house has the triple advantage of being quickly completed and habitable, of being less costly to build, and of providing at the time of its demolition a marvellous fertilizer for certain types of soil."

Abbé Rosier:
 "New Complete Course of Architecture",
 published in 1786 by a Group of academicians and agriculturalists.



FIGURE 40: BOURDENOUS CHURCH
 (NEAR CORVELIN-ISERE, FRANCE).



COINTERAUX IN 1790...

"(...) All the strangers travelling along the banks of the Saône in the convenient and comfortable stage-coaches to be found there never dreamt on seeing these elegant, these delightful country houses that they were built solely with earth. (...)

Allow me to observe that this building method should be employed all over the country, both to enhance our villages and our national honour, and to save the wood that is used in such large quantities for building, thus at once avoiding the risk of fire and sheltering the working people from extremes of heat and cold (...).

Bakers on the outskirts of Lyon prefer to keep their flour in store-rooms built of rammed earth, because experience has taught them that rats and vermin cannot penetrate their massive walls (...). A Parisian who had visited the Lyon region and learnt that houses could be built of earth alone resolved to build a house in Paris, near the Hôtel des Invalides, using this method. The authorities having withheld permission for him to lay the roof, the building remains without cover. This will be the fifth winter that the unprotected structure has been exposed to all the rigours of the weather: rain, snow, drought, wind, storms, in a word all possible unfavourable conditions (...). I never fail to go and see this structure and I find it always in the same condition: it has yet to collapse (...).

- Rammed earth acquires solidity thanks to the compaction which reduces its volume and eliminates any air.

- If it is to last 200 years, the complete evaporation of its natural humidity must be achieved. - The plasticity of earth causes all the particles to bind together thanks to the artificially contrived effect of the repeated blows of the rammer (...) similar to the natural adhesion which occurs in rock formation (...)"

TRADITIONAL HOUSE OF THE

FIGURE 45: HOUSE FROM THE DAUPHINE REGION! — HIGH WALLS AND LITTLE ROOF OVERHANG.

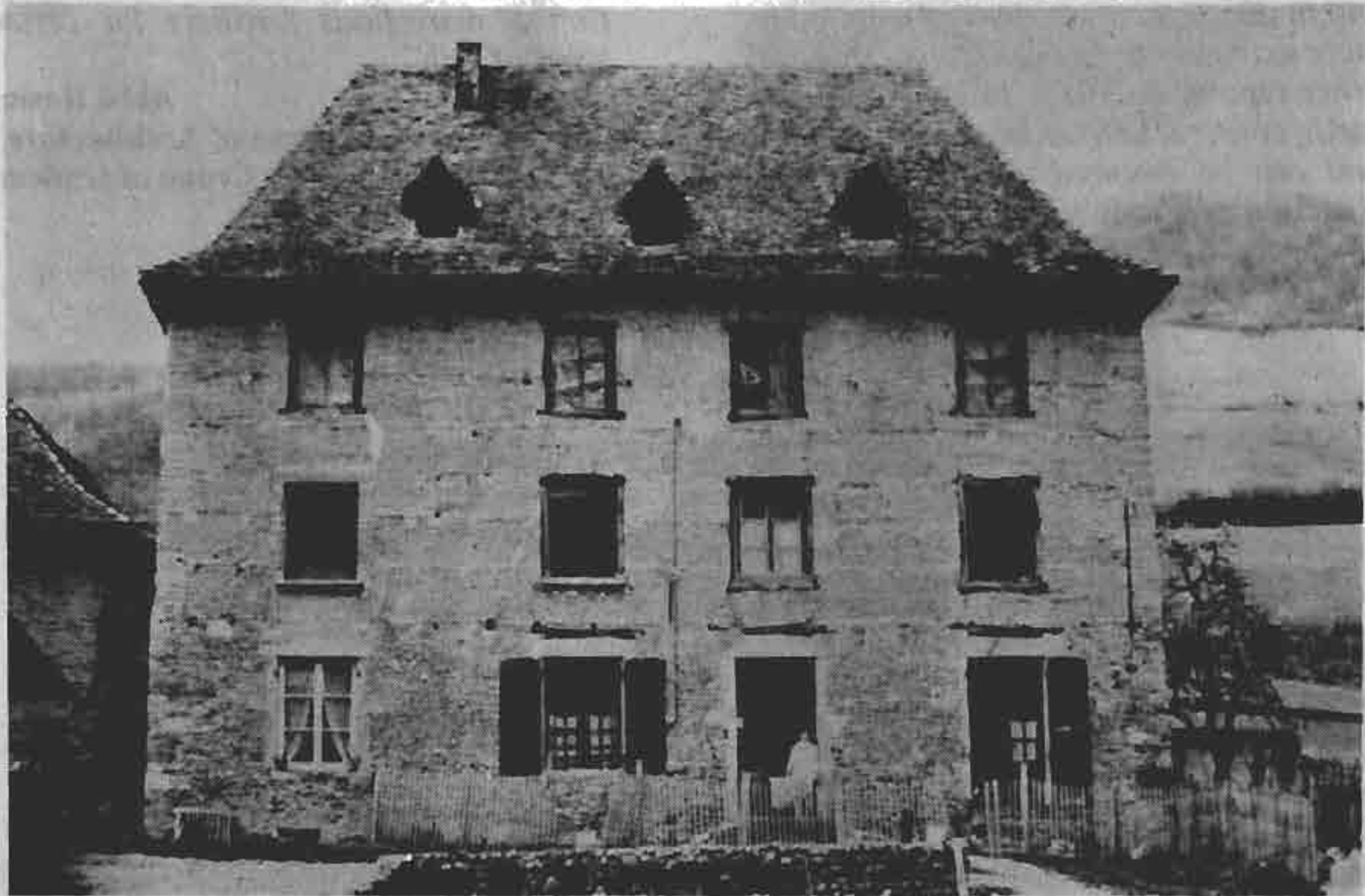

CRA Terre

LOWER-DAUPHINE REGION, (FRANCE)

We considered what might be the relationship between a family and a given space: that of their own home. In what way is this space primarily a dwelling, a cultural response to roles defined by a community and a way of life? How is this relationship physically represented in space and how does the space itself interact with it and change it? A dwelling, moreover, also reflects the circumstances and practices underlying the building process which erected it. Social custom, collective help, materials employed..., all come together to form the cohesive whole which finds expression in the completed house. This in turn not only reflects its owner, but also expresses something particular to the community which has been the silent custodian of its deeply-rooted forms. There seems to exist a common core from which are drawn and replicated the building types used. The houses of the lower Dauphin region all share a very clear family likeness, and at the same time the addition of a whole range of variants allows each individual to leave his or her mark on their home.

Our remarks are prompted by the factual material gathered in the course of a study on rural habitat begun in 1945 by G.H. Rivière who was at the time curator of the Museum of Popular Art and Tradition. The findings, which are currently being published, will form a twenty-two volume collection of which the twenty-first, designed and edited by H. Raulin, was published in 1977 by Berger Levrault. It is in this volume that the monograph which served as the basis for our own study is to be found.

The village of Brézins, in the Lower-Dauphiné, is located between St.André and St.Etienne de St.Goirs. There is nothing to differentiate this essentially agricultural community of 830 inhabitants from neighbouring villages. Its many rammed earth buildings reflect the traditional form of housing of the plain of Bièvre.

MARIE.

Albert and Marie's House



CRATerre

Albert and Marie, 80 and 79 years old respectively, live in an old rammed earth farmhouse with foundations in rough-cast river stone (fig. 47). A wide canopy protects the main facade from inclement weather. Until the second world war, rammed earth was the "normal" method of building in the area. Thus Albert, like most local men, used to employ this technique: he recalled for us the context of the traditional society in which it was used. "Social cohesion at the time was much stronger, everyone did their bit for nothing. We helped each other out with the tough jobs. You were obliged to help those who had helped you" ... "The owner would go round visiting all the fellows who were going to help with the building work. Come the first fine weather, we'd all get to work. We never begrudged our time and we worked long hours!"

It took ten men or so to put up a rammed earth building. Three of them excavated the earth and broke it down finer; we used to call that "making the earth". Round here there was good earth everywhere and all you had to do was dig through the thin ploughed layer to reach the clay layer. Often we would wet the earth a little as this made it easier to tamp. Three others would transport the earth in canvas bags holding about 50 kilos and would pour it between the formwork where three strong men tamped it down. "The lads doing the tamping needed good strong arms!" Albert told us. "They would lift the tamp right over



FIGURE 47: FACADE OF THE LIVING ACCOMMODATION.

CRATerre

their heads and then let it go letting their arms drop down with it," and so on. "If they worked all day they would manage to complete 7 or 8 sections. We would put up two courses without stopping and then we would cover the walls with tiles to keep the rain off and let them dry out for a fortnight. Then we'd start up again."

Usually three months would elapse between starting and finishing the major building work. Once the walls were up and the roof truss was in place, the "ravola" would not be far off: a bouquet of fir decked with ribbons was tied to the apex of the roof and the owner would treat everyone to a meal with plenty of wine to drink. The evening would be a jolly affair with plenty of drinking and singing.

The role of the carpenter

Albert drew our attention to the particular part played by the carpenter during the various stages of the building work. He was the first craftsman on whom the owner would call, discussing with him the site, the orientation of the building and its design. The carpenter would then sort and square off the timber assembled on the site for the roof trusses. His advice and presence there were indispensable. His role was akin to that of a contractor as his opinions, the fruit of his long experience, were generally sound and his advice was much sought after. As the owner of the shuttering, (Brézins had 3 pairs), the carpenter would set it up himself. Officially the owner was directing the works, but in practice it was the carpenter who was in charge, and it was to him that one would turn with tricky problems.

Any new building work was given a lot of thought beforehand and required a great deal of preparation. It also provided the opportunity to strengthen family ties, as well as professional and friendly relations, amongst members of the community and occasionally to reassert the owner's social status. The owner was responsible for providing the necessary materials. The stones would come from his own fields, collected and piled up during ploughing, and he would transport them by cart to the site of the new building. Timber for the roof and for the wood-work would often be donated by the parents when they were in a position to help their children. Some materials had also to be purchased, in particular lime and local tiles from St.Pierre de Bressieux.

A walk round one man's home ...

Marie and Albert did not build their house, they inherited it, but they had been living there for the last thirty years. The farm used to belong to Albert's grandparents. In their day, the buildings originally formed a single rectangle, facing full south, and an open barn separated the living accommodation, then already over 200 years old, from the various outbuildings. The second barn, which gave the buildings their present L-shape, was built by Albert's grandfather. Less significant changes followed. His father rebuilt the house openings in brick, a common local practice. When the path of the road alongside the property was modified leaving a gap between it and the house, his father filled it in with the present store-room and attic. Albert made no significant changes to the buildings which despite the successive modifications retained a strong sense of cohesion.

Before penetrating further into the house, let us retrace our steps a little, and view the property as a whole with its house, barns, attics, hen-coops, hay-loft, open barn and courtyard, all essentially devoted to agricultural activities (fig. 49). The family lived on a mixed farming system and bred cows for milk production. In 1945 the property covered 35

FIGURE 49: SITE PLAN

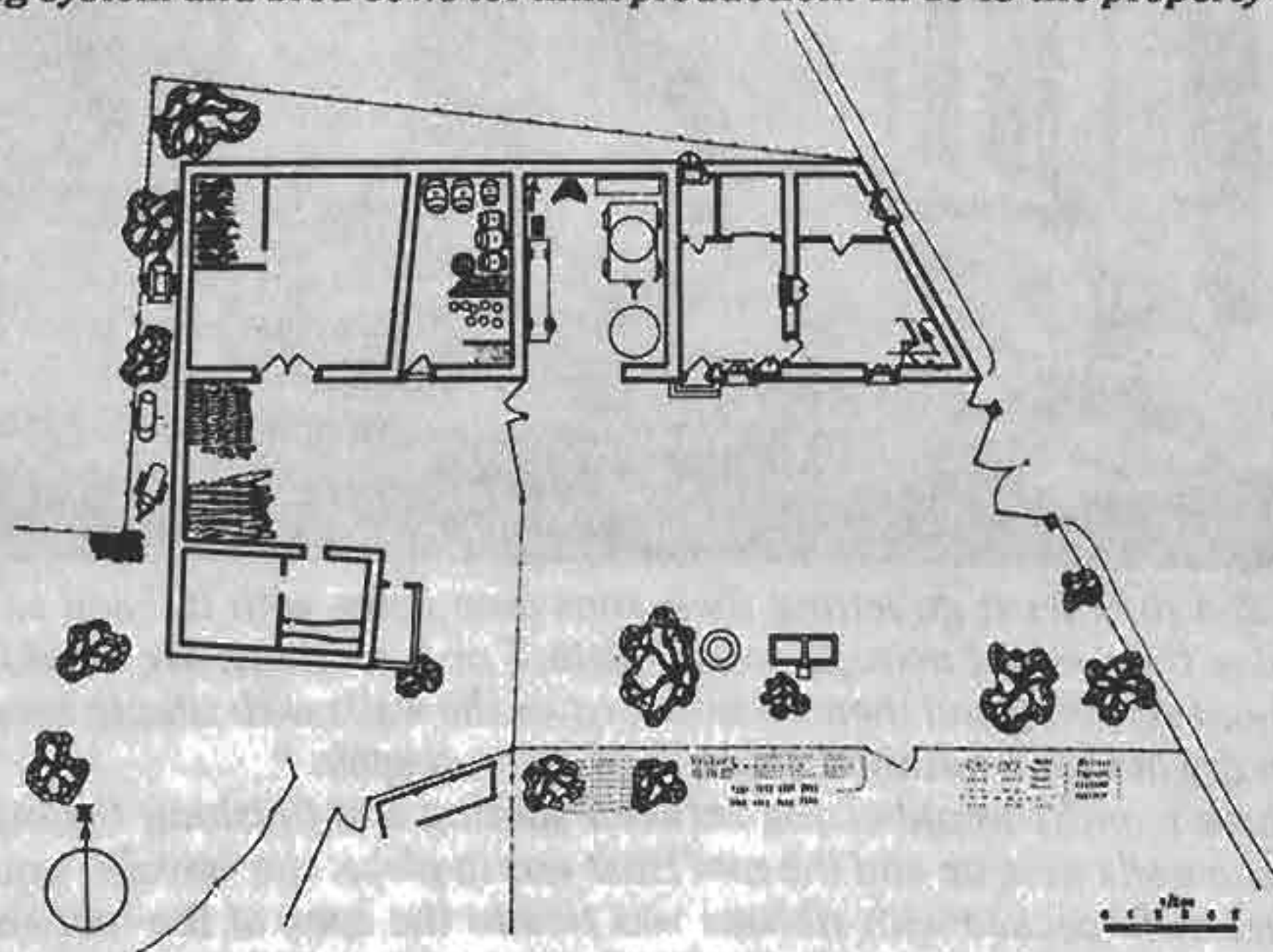

Charles Boyer de Bouillane

hectares and could boast 2 mules, 8 calves, 4 sheep, 30 hens, 10 rabbits and a dog. When we began our study the land had been leased out for over 20 years and the animals had gradually disappeared; only a few hens and three hunting dogs were left. The buildings remained unused and the old agricultural machinery stood idle in the barn. Only the house still lived, condensing all the relationships between the inhabitants and their home (fig. 50).

For Albert, a war veteran who now had outside work, the house seemed to be a safe haven where he could enjoy some peace and quiet. The man of the house would return

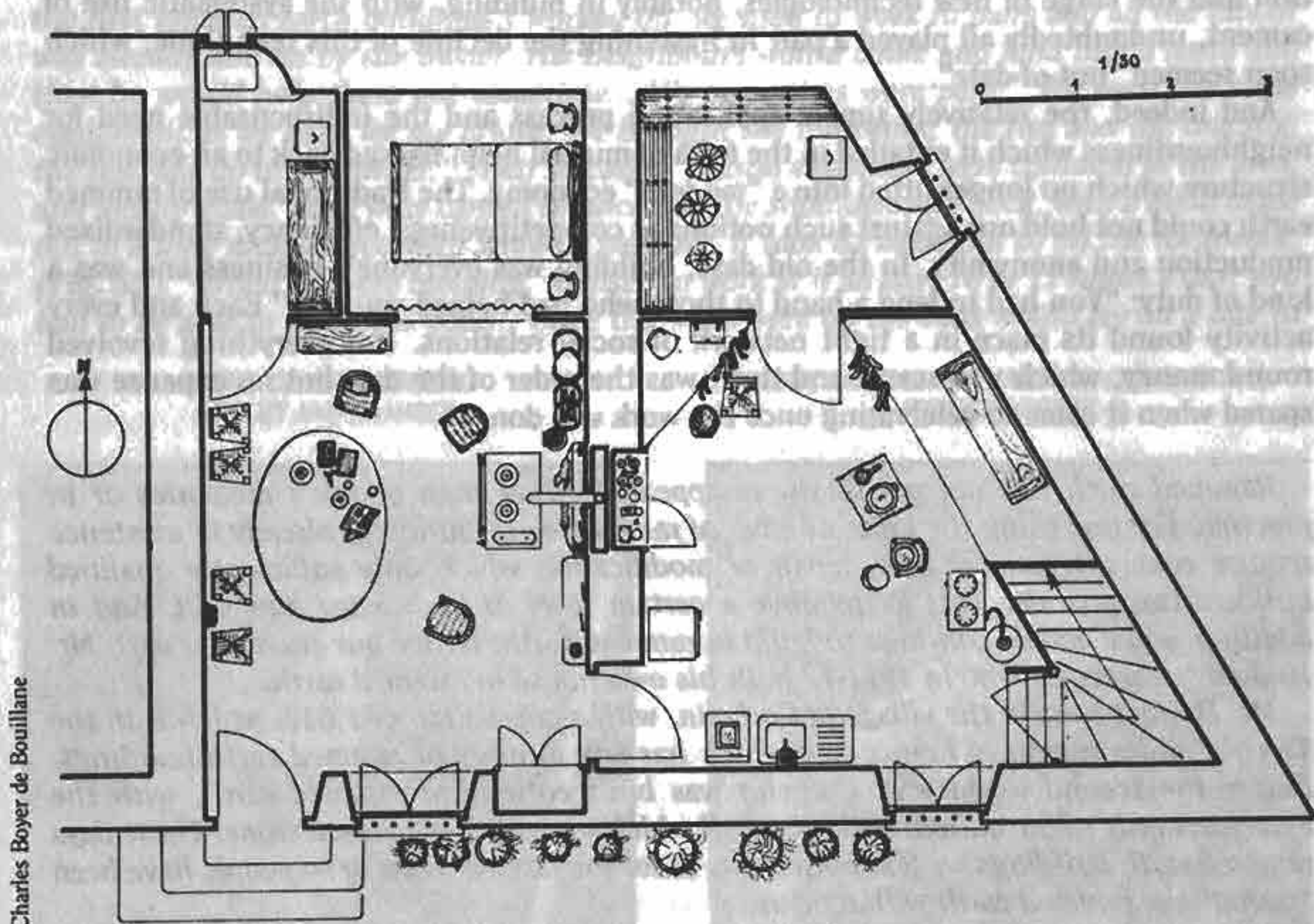

FIGURE 50: THE LIVING ACCOMMODATION

from work, his wife served him his meal, the newspaper would be waiting for him on the table together with his glass of wine, an essential ingredient in "cheering things up a bit". The walls bore witness both to Albert's personal souvenirs and to the typical masculine values of hunting and war: a pair of shells converted into a vase and a frame of war decorations from the '14-'18 war. Two shot guns and an air-gun hanging on a rack, together with the scenes depicted on the waxed table cloth, evoked a permanent hunting tableau.

But the inside of the house was Marie's territory. The first thing she did when she moved in was throw everything out and redecorate. "It was all dirty and rotten." In an attempt to remove all traces of the past, she wanted to "start with a clean sweep." Marie, as we all do, carried with her both her own story and that of her family. The bed, the wardrobe, the table and the cooking stove were after all her dowry in 1917. Marie lost no time in staking her claim by moving her own things in: the table was placed in the middle of the room, the stove in the unused fireplace, the wardrobe set back a little, and the bed, half-hidden, in an alcove with a white lace curtain hinting at its presence. The way the furniture was arranged had remained unchanged (in 1975) since 1940. Pregnant with meaning and polished with oft-repeated gestures, these objects seemed to have fused with the walls and the floor, to have taken root in the house. Only little souvenirs, photos and trinkets came and went over the years according to the shifting patterns of human emotions.

RAMMED EARTH BUILDING IN 1972

In France until the 1950's traditional rammed earth building as we have just described it was commonly used by a certain section of the rural population. There followed its rapid decline and then virtual disappearance, perhaps linked to the breaking up of rural society. Post-war changes, the drive towards industrialization and modernization, rural depopulation and the surge of new technologies, notably in building, with the systematic use of cement, undoubtedly all played a part in hastening the decline of this technique, which soon seemed "out-of-date".

And indeed, the relatively simple application process and the indispensable need for neighbourliness which it entailed in the form of mutual help, harked back to an economic structure which no longer fitted into a "modern" economy. The traditional use of rammed earth could not hold out against such notions as competitiveness, efficiency, standardized production and anonymity. In the old days, building was everyone's business and was a kind of duty: "You had to lend a hand to those who had helped you out." Each and every activity found its place in a tight network of social relations. Not everything revolved round money, which was scarce and thrift was the order of the day, but no expense was spared when it came to celebrating once the work was done.

Rammed earth has not yet totally disappeared either from people's memories or in practice. For one thing the great number of rammed earth buildings already in existence require constant maintenance, repair or modification which only sufficiently qualified builders can provide. This keeps alive a certain level of knowledge and skill. And in addition, some people continue to build in rammed earth. Hence our encounter with Mr. Huguet, a carpenter who in 1971-72 built his own house in rammed earth.

Mr. Huguet lives in the village of Corbelin, with a population of 1,612, which is in the Terres-Froides region of France and which has any number of rammed earth buildings. Before the second world war, Corbelin was built entirely of rammed earth, with the exception only of the church and town hall which were built of dressed stone! These days rammed earth buildings are less noticeable, as for the last ten years or so people have been "facing" the rammed earth with renders.

FIGURE 51: MR. HUGUET'S RAMMED EARTH HOUSE



Conversation with a carpenter

Mr. Huguet had learnt not only carpentry from a local tradesman in Corbelin, but also how to build in rammed earth, as in that area, "it was the carpenters who did the rammed earth building". He had been involved in and subsequently supervised traditional rammed earth building works. He had observed the decline of this technique and with the exception of his own house, which he thought would be the last of its kind, had not constructed a single rammed earth building in the previous ten years.

30 years or more before, there was plenty of rammed earth building still going on. "For the first rammed earth buildings I worked on, we used to work in pairs and all the labour was already laid on by the owner. His neighbours would come and lend him a hand and then he would help them out sometime... We carpenters were paid... We used the same equipment as we used for my house. We brought the formwork, the ties and the bracing; the rest was up to the owner." Their so-called "mason's baskets" were common in the area, and locally made. They were carried balanced on the shoulders and neck, with a hood made out of a lime sack stuffed with straw as padding. It took 82 basketful to fill the formwork. (Fig. 53). "When we were tamping, we used to work at it all day, 10 or 11 hours a day; you had to be able to stand the pace... Once the walls were up the boss would lay on a bite to

FIGURE 52: TRADITIONAL BASKET AND RAMMER

FIGURE 53: HOW THE EARTH IS CARRIED IN A WICKER BASKET



CRATerre

Nathalie Sabatier

eat for us. The second time we'd raise our glasses was when the roof was on: in these parts it's the carpenters who lay the roof tiles... There was no shortage of people to carry the tiles up for us, and we've have a really good celebration!"

Mr. Huguet had never tried to modernize an old rammed earth house because "it's as expensive as building a new one. You can't expect too much from old buildings! ... You need fellows who are used to working with rammed earth or they'd have the whole bloody lot down. Then again, you can't just make a hole in there like in a concrete wall. You have to shore it up. Openings have to be done in two goes: you cut away half, then put in the

lintel, then finish the rest... Restoring a rammed earth building is a mason's work and I'm no mason."

On the other hand, Mr. Huguet had always had the idea of building in rammed earth: "I always said that the day I built a house it would be in rammed earth... it keeps you cool in summer and warm in winter. No need for any insulation. Otherwise... There's nothing to touch it."

With its handsome white render and its openings all round the walls, his house is indistinguishable from modern detached houses. The roof is pitched for reasons of economy since two rooms have been built under the eaves. Slate was selected in preference to overlapping tiles which retain too much powdery snow.

Building the house

To build his house, Mr. Huguet and his team used the same wooden formworks used in the past, 3 metres long by 0.96 m high. They weren't his own, as he no longer had any; he had to borrow them from his former boss, also a carpenter, who had held onto his. They didn't significantly modify the technique. As this area had good earth everywhere, they simply used the earth excavated to build the foundations. There was therefore no need to do any extra digging and there was plenty of earth with some to spare. The loan of the mason's crane, which he didn't need for a while, to transport the earth, reduced their workload by half.

Five of them, Mr. Huguet and four of his carpenters, built the walls from June to September, working in slack periods when the demands of the carpentry workshop permitted. The workers were paid, "it was a job like any other". Two of them had already worked with rammed earth.

They raised four courses of rammed earth plus the gable-ends on concrete foundations, starting by building two courses, then waiting a fortnight for them to dry out. Mr. Huguet stressed the importance of protecting the finished walls from rain. "If it rains, the whole lot will come down!" Each section takes in all one and a half to one and a quarter hours. With five of them working, they tamped about 20 m² per day.

The door and window frames were made of concrete. They put a little mortar into the formwork to bond the joints. Only the external walls of the house are in rammed earth; the inside walls are not load-bearing.

The external render was done by a mason, since that was not a carpenter's job, according to Mr. Huguet. A carpenter is one kind of specialist, a mason another. Nevertheless he did go so far as to say that a lime render was better than cement. "If you put processed cement onto rammed earth, it holds! If it doesn't hold, it's because it's mixed too thick. In the old days, when they used a light lime coating, it would hold for perhaps ... several generations! ... I think you need two wheelbarrow loads of sand for each sack of lime."

Mr. Huguet hadn't calculated the exact cost of his house. But he did mention the saving in insulation. He stressed the problems of trying to cost the time spent on site by his own team, but added that in any case "it takes longer and you need more people... but you gain on one thing, the raw material doesn't cost you a penny!..." On the other hand he said that he had just managed to get by with the roofing and used copper guttering because with the slate overhang, he could dispense with zinc. "So that's all I had and I said to myself why not copper guttering, it's as good an idea as any other and it's stronger."

Mr. Huguet is sceptical about the possibility of local or other companies taking up this type of building again. It is not so much the material obstacles, such as the time needed and the number of workers, stopping them, as the problem of protecting the walls. "It's just not possible these days. It's impossible to put covers on all round and ... it would be more trouble moving the covers (each time a new section was started) than doing the work ... and when it rains, the water runs off the consoles onto the walls and spoils all the fresh earth!"

Even if he were asked to build he is not sure he would accept. "You have to consider costs... it's no small undertaking nowadays..." On the other hand, Mr. Huguet thinks that "in poor countries where there is plenty of labour available, that's fine! .. but here this building method is finished for good," he concluded. Traditional rammed earth has failed to survive our society's balance sheet mentality.

RAMMED EARTH CONSTRUCTION IN MOROCCO: ANOTHER DIMENSION

In contrast to rammed earth as practised in France, which we have just reviewed, earth building in Morocco is of monumental proportions.

One might be tempted to believe that earth architecture is restricted to individual dwellings only a few floors high: the fortified communal "villages" - in the original Berber "ksour" or "irhem" - which shelter the entire local population in a veritable bee-hive world of enclosed corridors and simple-beaten earth chambers, provide living proof that it is quite possible for a technique such as rammed earth to produce very varied spaces and, in the present instance, to create architectural structures of most imposing proportions (fig. 55).

In general the building of a ksour uses rammed earth for the walls and adobe bricks for the mural decorations on the facade, around the

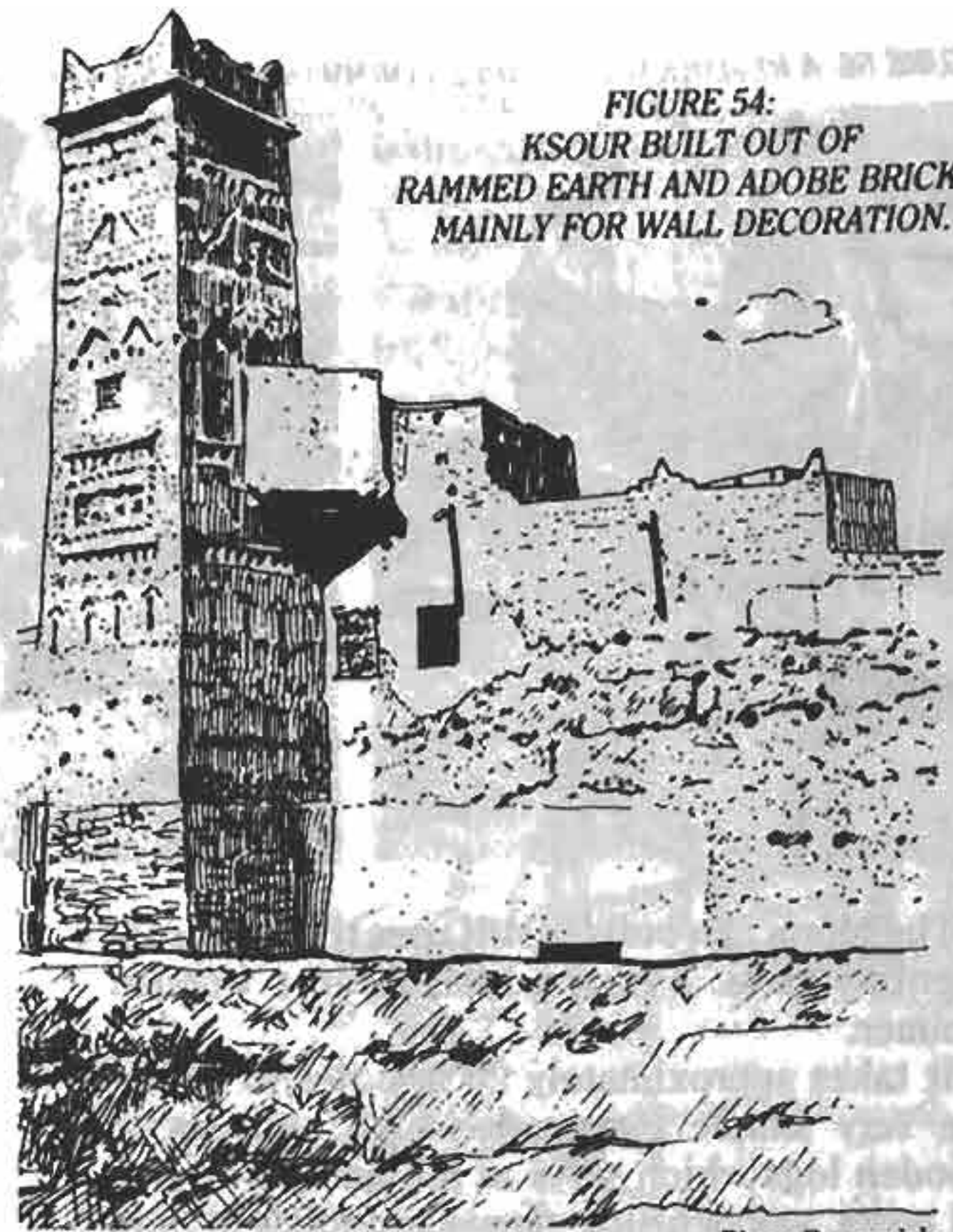
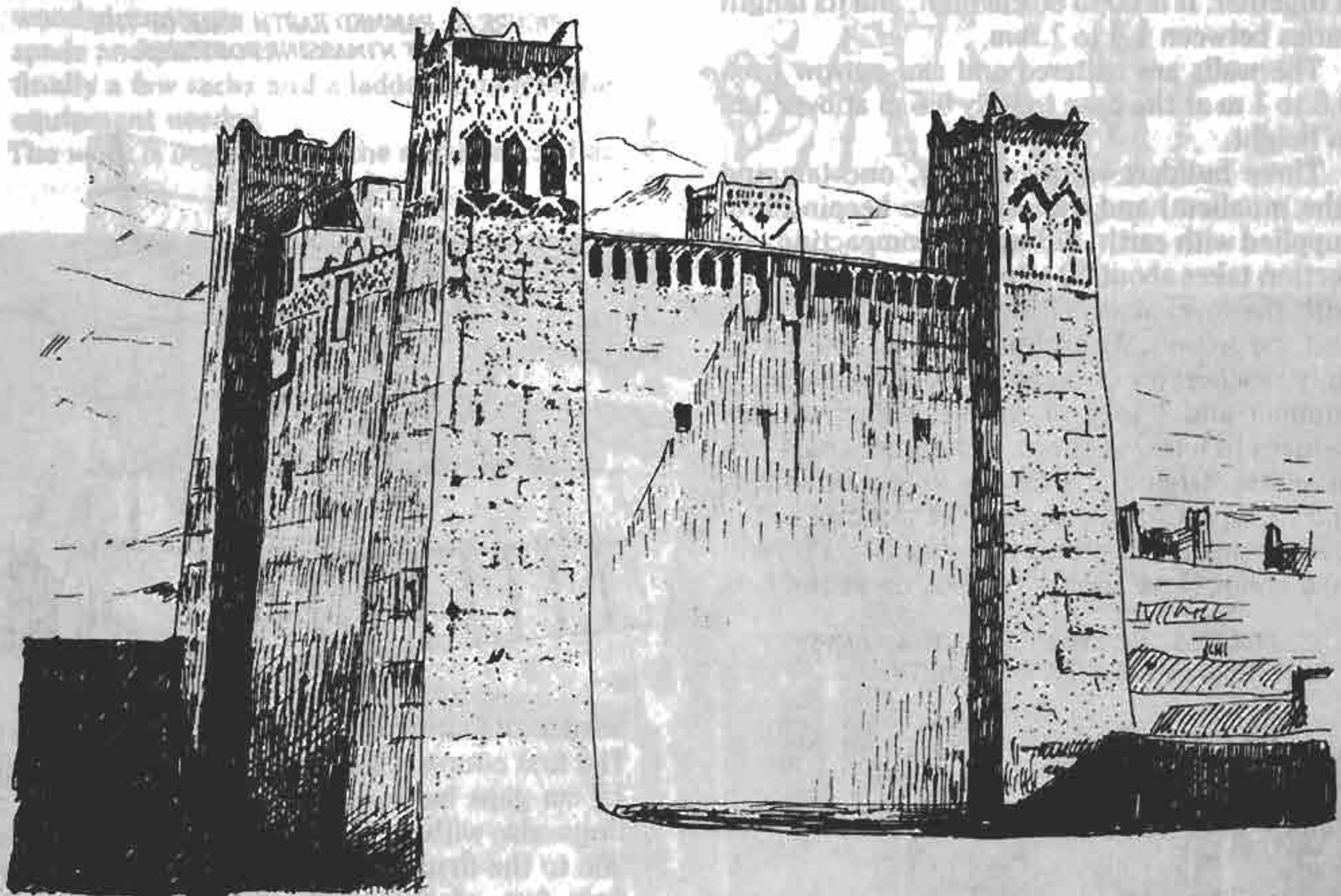

FIGURE 54:
KSOUR BUILT OUT OF
RAMMED EARTH AND ADOBE BRICKS,
MAINLY FOR WALL DECORATION.

Pierre Bonneville



Pierre Bonneville

FIGURE 55: KSOUR

openings and on the stairways, and requires a dozen men for a modest sized building, and up to a hundred for a large one. There is strictly speaking no architect, but there is a site-foreman (the "mohandes"), and two different master masons ("muallem") are responsible for

the rammed earth and the adobe work.

The foundations, 50 cm deep, are filled with stone rubble (lime and earth mortar), and extend into a footing 20 to 50 cm high on which the first formworks will be set up.

FIGURE 56: A REMARKABLY SIMPLE FORMWORK GIVES A VERY NEAT FINISH.



Dirk Belmans

The Moroccan builder still uses the most rudimentary tools: a hoe, a basket and a wooden rammer.

It takes approximately 20 minutes to set up the very simple formwork which consists of wooden logs which serve as putlocks and vertical posts, wooden side-panels and ropes to hold it together. It is 60 to 80 cm high, and its length varies between 1.4 to 1.8 m.

The walls are battered and can narrow from 0.8 to 1 m at the base to only 0.6 m at over 3 m in height.

Three builders work together, one tamping (the muallem) and the other two keeping him supplied with earth. Filling and compacting one section takes about 40 minutes, the rate varying with the level at which the work is being done and the season. At ground level, daily production reaches on average 8 to 10 sections in summer and 4 to 6 in winter; higher up this reduces to 6 to 7 sections in summer and 4 to 5 in winter. Drying out time is longer in winter, and transporting the earth more difficult as the walls go up. A two-storey building 12 x 12m will take about three months to put up at the best

FIGURE 57: GATEWAY TO THE TOWN OF FEZ (BUILT IN RAMMED EARTH)

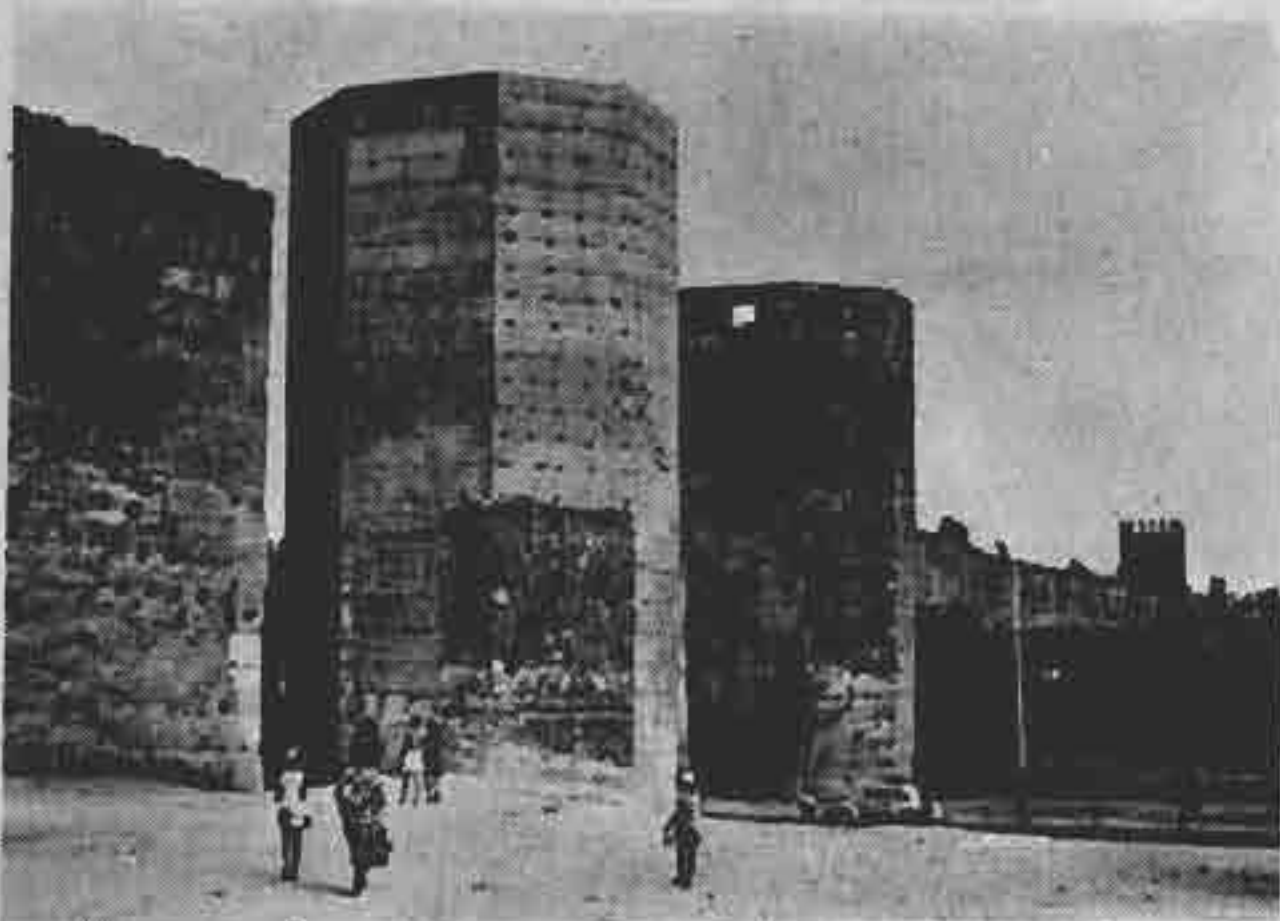

CRATerre

time of year (March to October) and will require 700 to 800 hours work.

Morocco also has a few rare surviving examples reflecting a particular way of building with rammed earth, such as the Tirhermt n'Imassine fortress: here the walls are built up in alternating courses of rammed earth sections forming a

FIGURE 58: RAMMED EARTH WALL OF THE TIRHERMT N'IMASSINE FORTRESS.

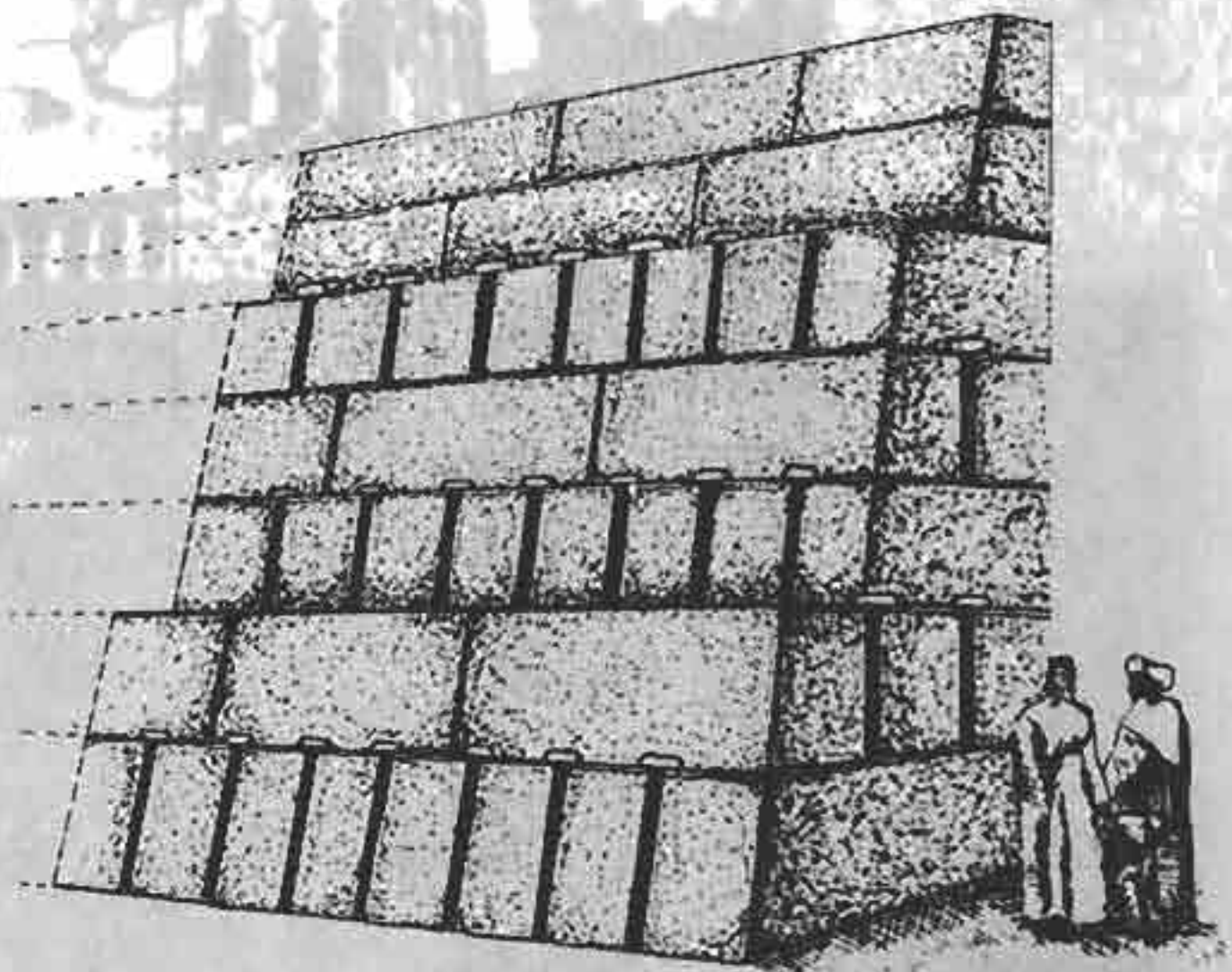

CRATerre

header and stretcher bonding pattern (fig. 58). The first course is built of parallel sections with 15 cm gaps between them. Three rows of sections, also with gaps between them, are added at 90° to the first course. The third course covers only two of the three sections immediately below. The overall effect is of a massive stepped lower wall on top of which is built an ordinary rammed earth wall. The sections were some 0.9 to 1 m high and 0.45 to 0.55 m wide. This costly and time-consuming construction method, dictated by military considerations, has now been completely abandoned.

RAMMED EARTH IN THE ANDES CORDILLERA: TAPIA

Earth buildings make up 60% of the Peruvian built environment. Most are in rammed earth or adobe, which seems to predominate in the coastal areas. Although it is difficult to be specific about where rammed earth buildings are to be found, they are very common in the mountainous areas.

Our description of the application of rammed earth in France used personal accounts and writings from the past; in this case it is illustrated thanks to documents from Huancavelica where the peasants traditionally build in rammed earth. Here, in contrast to other countries, the technique is very much alive and well.

The equipment used (fig. 59) is very similar to that used in France, including:

- side-panels of the wooden formwork (160 × 55cm);
- end-board;
- metal rods serving as ties;
- wooden rammer;
- spade and pick-axe;
- finally a few sacks and a ladder complete the equipment needed.

The work is organized in the same way as has

already been described (fig. 60):

- 1 The earth is directly excavated near the site for the building (no transport problems).
2. After excavation it is shoveled into sacks.
3. The builder carries it up on his back.
4. It is emptied into the form and spread around.
5. A rammer, sometimes made out of a large

FIGURE 60:
SITE ORGANISATION.

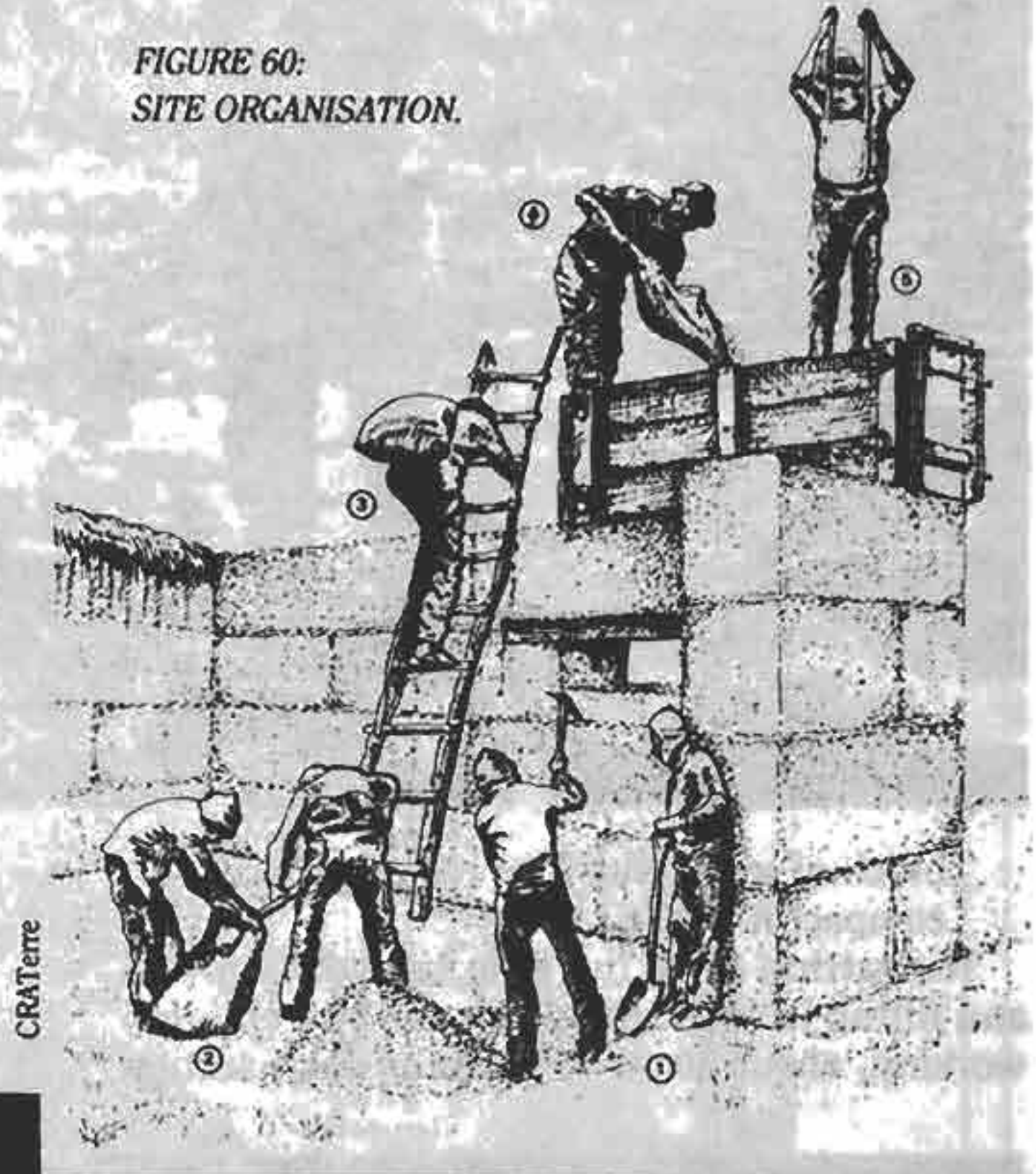

FIGURE 59: TOOLS USED FOR RAMMED EARTH IN PERU (HUANCAVELICA)



CRATerre

block of wood with two handles, is used to compact it (fig. 61).

The setting up of the form takes 20 minutes and filling it, with three men and two children working, about 40 to 50 minutes; each section

measures 140×45 cm, and the wall is 40 cm thick. The finished walls are covered with Ichu thatch before the roof is put on both to protect them from rain and to prevent them from drying out too quickly (fig. 62).

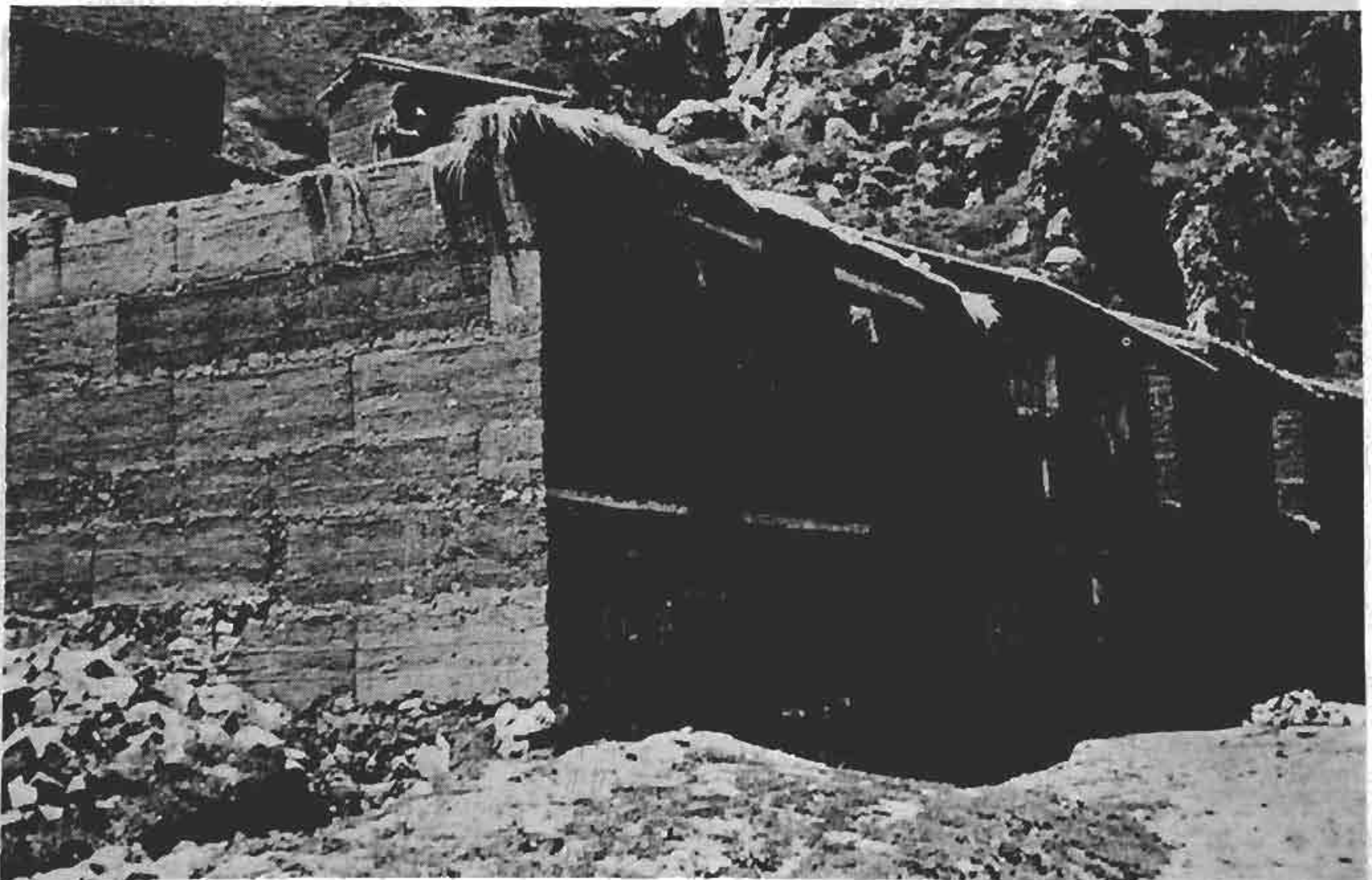

CRATerre

FIGURE 62: PERU (HUANCAVELICA)

II - RAMMED EARTH TODAY

The abandonment of the use of rammed earth in certain industrialized countries such as France is the result not so much of technical problems as of socio-economic factors.

After the war, studies in various parts of the world attempted to update the process, seeking at a time of scarcity a means of producing housing at low cost. The demands of economic and physical reconstruction gave rise to official earth construction housing projects.

In Germany, several thousand rural buildings were planned and five centres were moreover set up to provide practical help, the "know-how" for rammed earth building, by encouraging the application of modern technologies and the training of specialized entrepreneurs.



Eduard Pommer

FIGURE 65: MR. SIEBOLT'S RAMMED EARTH HOUSE IN BIELEFELD (GERMANY).

In France, a few experimental buildings appeared. Attempts were made to import the technique to areas where it was previously unknown, such as the Somme, where two model farms were built in rammed earth at "Bosquel". Studies carried out during construction resulted in recommendations given in the REEF.

There is no shortage of examples from the U.S.A., Canada, England, Belgium, Denmark, Sweden, Australia etc. Nearly every industrialized country has tried to update this building method.

Having reviewed the traditional methods of building with rammed earth, the second part of this chapter is devoted to various experiments which have been carried out in recent years. The list which follows, although undoubtedly incomplete, helps put our ideas and sources of technical analysis into context.

**FIGURE 63: RAMMED EARTH BUILDING IN MEXICO;
THE EARTH IS DUG RIGHT AT THE FOOT OF THE WALL.**



Pierre Bonneville

COUNTRY	YEAR	PLACE	PROJECT
FRANCE	1945-46	Somme (near Amiens), Village of "Bosquels"	Reconstruction of a village 95% destroyed in 1940. (Ministry of Reconstruction and Urbanism). In the event 2 dwellings + 1 large stable + 1 agricultural building were built experimentally in S.S.C.. The studies led to recommendations in REEF. Architects: Dufournet. Engineer: Florentin.
	1946	Pas-de-Calais (near Hesdin), Village of Vacqueriette.	12 farm project. In the event 1 experimental farm. Architect: M. Philippe. Contractor: M. Dejean.
	1950	Aisne (near Soisson), SNCF Tergnier complex	Project for 500 housing units. In the event 1 trial house. Architect: Dufournet. Company Thomas-Kotland.
	1976	Isère (near Bourgoin), Vignieu	Village enlargement project (abortive). Feasibility study (rehabilitation) of rammed earth construction mandated by the Ministry of Public Works: Overall responsibility: ADETEN. Construction of small experimental building.
ENGLAND	1920	Surrey (near Guildford), Newlands Corner	1 experimental house which served as a model for colonial work. Overall responsibility: C. Williams-Ellis.
	1927	Wiltshire, Amesbury	DSIR (Department of Scientific and Industrial Research) project. 4 experimental houses (successfully completed).
DENMARK	1929-1948	Kopenhagen Lyngby	1 rammed earth house. Architect S. Risom 1 rammed earth house. "Geotek" method.
NORWAY	1925	Mellbge Hedmark	1 200 m ³ house 1 rammed earth farm
SWEDEN	1921-1923	Harpling Hallard Hedviksnäs Tibro Ostra Odaralöv Lung Igelstorp	Many rammed earth buildings were put up. 1 house 1 house 1 house 1 house
MOROCCO	1967	Quarzazate	Official rural low-cost housing project, 5 vaulted houses built. Overall responsibility: Mr. Maasson - C.E.R.F.
ALGERIA	1973	Mostefa ben Brahim (near Sidi Bel Abès)	Official project - Building of 30 houses in SSC in the context of a pilot village of 300 housing units. Popular works of the CPRA Agrarian revolution. Overall responsibility: H. Houben, P. Pedrotti, D. Belmans.
CANADA	1943	University of Saskatchewan	Trials and experiments. Building of rammed earth walls.
U.S.A. ALASKA	1968	Anchorage	2 rammed earth houses built by "VISTA Volunteers".
U.S.A.	1935	Clemson (South Carolina)	Small experimental building put up by the Clemson College Engineering Experiment Station.
	1940	Cameron Valley (near Alexandria, Virginia)	Group of social housing units. Tom Hibben project.
	1959	Brookings	Experimental trials by the South Dakota State College
AUSTRALIA	1952	Sydney	Series of experiments at the Commonwealth Experimental Building Station.
INDIA	1950	Punjab	Project for housing units for 4,000 refugees. Engineers: P.L. Varma M.I.E., S.R. Mehra Amice.
NORTH KOREA	1955	Hamburg	Group of houses built with the help of rammed earth specialists from East Germany.

FIGURE 67/68: HOUSING BLOCK BUILT BY WIMPF IN WEILBURG IN THE 19TH CENTURY.

PHOTOGRAPH TAKEN IN 1920.

THE SAME BUILDING IN 1978

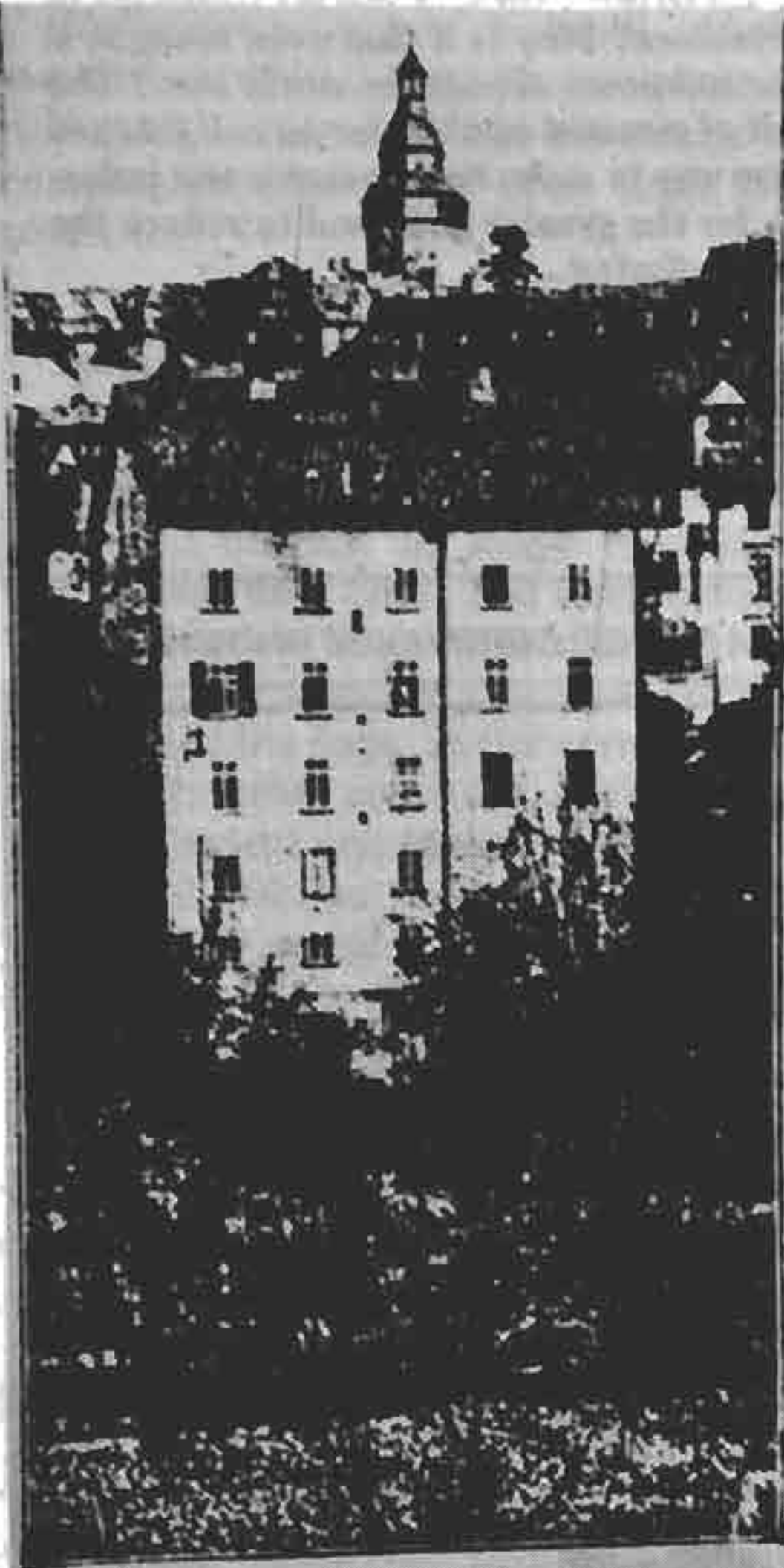

Eduard Pommer

Hildegard Erhard

Erdstampsbau von Wimpf in Weiltura.
Rückseite.

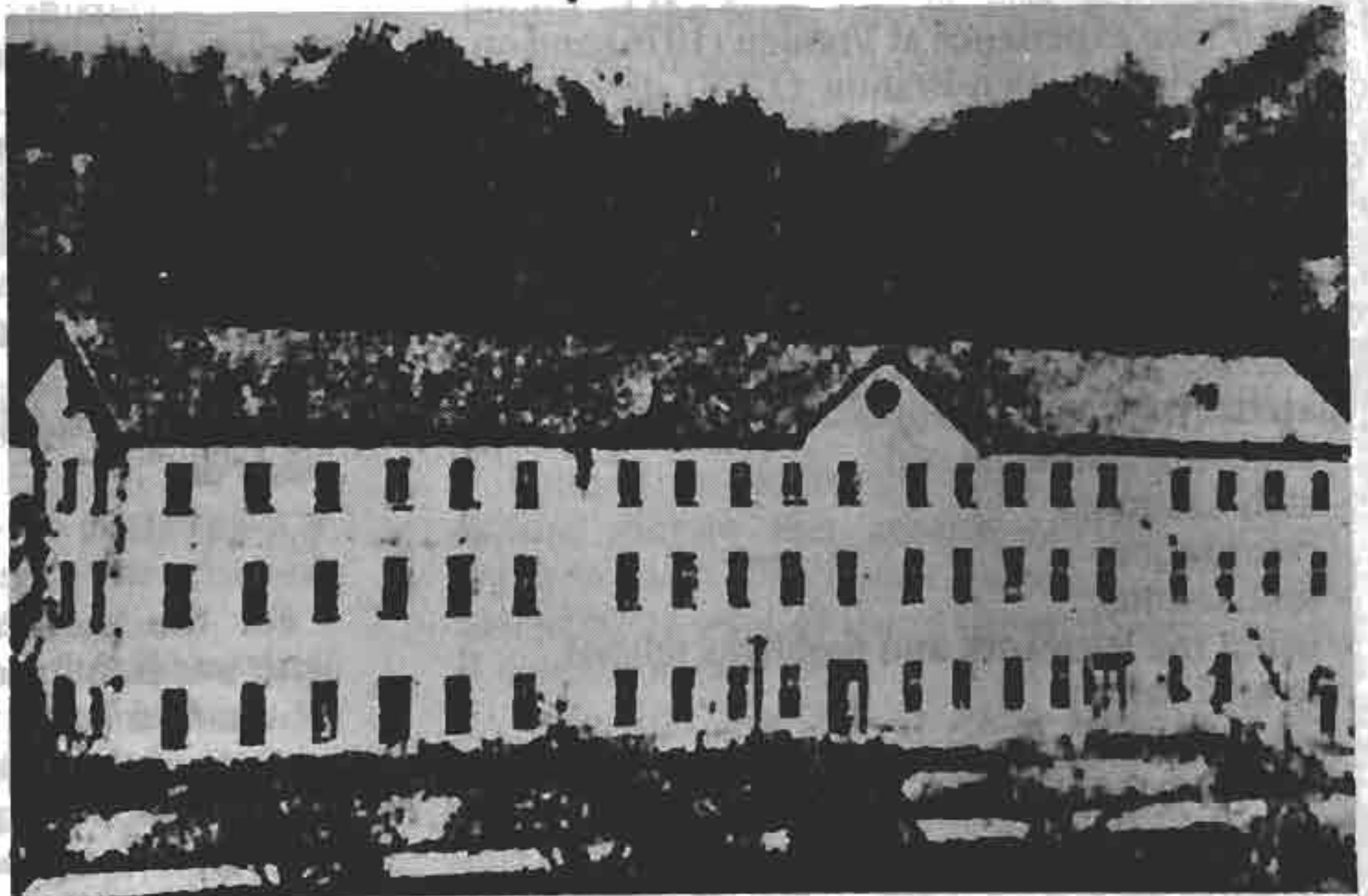

Eduard Pommer

FIGURE 66: CERAMIC FACTORY (RAMMED EARTH) BUILT BY WIMPF IN THE BEGINNING OF THE 19TH CENTURY. HAVING STOOD DERELICT FOR 45 YEARS (HOLED ROOF AND BROKEN WINDOWS), IN 1920 THE WALLS AND RENDERS OF THE BUILDING WERE STILL INTACT. DYNAMITE HAD TO BE USED TO DEMOLISH IT, THE RAMMED EARTH HAVING BEEN STABILIZED BY THE HEAT OF THE OVENS. IT NOW NO LONGER EXISTS.

"In truth, nothing could be cheaper than a rammed earth house!

Rammed earth replaces all other materials.

With rammed earth one can build anywhere, in any region; surely this is a gift from God to all mankind.

If all the sciences spring from Agriculture, then rammed earth must in turn be the first of the arts!

I exhort my fellow-citizens to acknowledge the benefits procured by my various original processes...

(...)

By what misfortune, then, is this art restricted to only one Province? Why is it that even today it is forgotten or unknown almost the world over? The precious Art of rammed earth is for an enlightened nation a sure way to make its commerce and industry flourish for the greater good and to reduce the lot of human suffering...

(...)"

Citizen Cointeraux
(School of Rural Architecture, Paris, 1790)

FIGURE 64: BUILDING A RAMMED EARTH HOUSE IN GREAT BRITAIN.

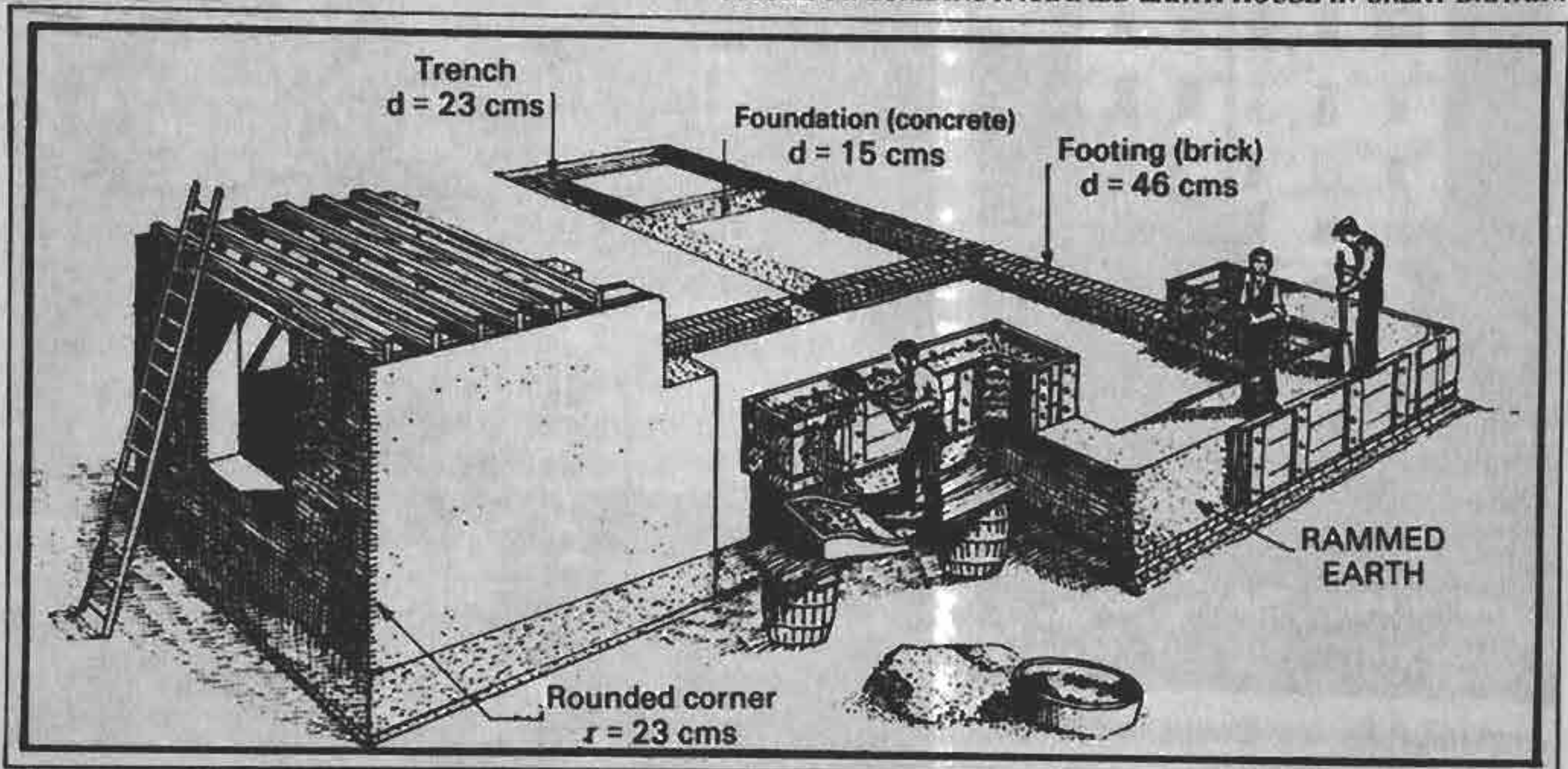

Philippe Durand

Our own experience at Vignieu (1976) and on site at Mostefa Ben-Brahim (1973) gives us a point of reference for a more objective overview of the various points raised so far. A fuller description of these building works is to be found at the end of this chapter.

Any attempt to "rehabilitate" rammed earth must take account of the problems raised by the material itself and its application, including:

- choosing a suitable soil;
- stabilization;
- compaction;
- foundations;
- using the formwork and problems related to application.

PROBLEMS RELATING TO THE MATERIAL

1. Choosing a suitable soil

Essentially related to research on public works provision (such as roads) soil analysis

studies, although relatively recent, enable one to select a soil, to determine its granular structure and if need be to correct it (see chapter on "stabilization"). The characteristics of a given soil (for example its optimal water content, an important consideration in rammed earth construction) can be determined by tests described in the chapter on "Soil analysis". Suffice it to say here that soil intended for rammed earth is used "dry".

2. Stabilization

For the purposes of experimentation, the earth was stabilized. To date the stabilizers used for rammed earth are cement and lime. A full account of stabilizers is given in the chapter on "Stabilization", a process which has given rise to a whole range of names. Thus for "stabilized rammed earth" the following terms are used: SSC (Stabilized Soil Concrete), Terracrete, Géo-béton, and Géoteck, Mécatér, Terradamente processes etc.

3. Compaction

Compaction is an essential stage of all rammed earth building. Research has been carried out into the efficiency of various tools and comparative tests have been made in several countries.

COMPACTION

A. MANUAL COMPACTION

Traditional rammers in Sweden, Australia and Brazil all differed in shape to quite a large extent (fig. 69). Some had shaped ends, others flat. In Sweden, three sorts of rammer were used according to whether one was working along the edge of the form, in the corners or down the middle. In other countries, such as Brazil, only one implement was used.

Several factors influence the choice of rammer: its weight, the area compacted (or striking area), the nature and size of the handle, the nature of the striking head, and the shape of the striking head.

a) **The optimum weight** of the striking head is in the order of 5 to 9 kilos. This can vary, however, according to the height and the strength of the builder. As a general rule the weight of the head in relation to the area compacted is 80 to 250 gms/cm². (The "Centro regional de Ayuda Technica," Mexico, suggests 100 to 140 gms/cm², which falls within the range given above).

b) **The area compacted** is ideally around 64 cm² (8 × 8) and in principle should not exceed 225 cm² (15 × 15) (Australian rammer).

c) **The handle** can be of sanded wood (a fragile material) or metal (which is stronger). Hollow metal tubes of 4 cm in diameter which enable one to vary the weight of the rammer can also be used. The length of the handle varies between 1.5 and 1.8 metres.

d) **The head** can be made of wood or metal. To avoid them getting too quickly worn or cracked, wooden rammers need to be shod either with a metal plate or with nails.

Wooden rammers are easy to make and if necessary can be made on site, to the required shape according to the job to be done.

Metallic rammers are easier to handle as they have smaller heads. Very strong rammers made out of cast iron are also to be found.

e) **The shape of the striking head.** Rammer heads come in various shapes and sizes the advantages and relative merits of which are set out below. Round heads do less damage to the forms but compaction around the edge of the form is less good. At all events, rounding of the

vertical corners is desirable as this avoids damage to the formwork and injury. Traditionally it was thought that the best results were obtained with a pointed head. South Dakota State College, (U.S.A.), has tested various shapes (fig. 70 A1).

The test consisted in using different rammers to compact 5 experimental blocks containing 37.2% sand. These were then laboratory tested for compressive strength.

The results were as follows:

- for a flat-headed rammer (180°), the (average) compressive strength was 35 kg/cm²;
- for a rammer with an angled head (120°), it was 35 kg/cm²;
- finally with a pointed head (90°), a result of 25 kg/cm² was obtained.

From the point of view of compressive strength, flat headed-rammers give significantly better results than those with conical-shaped heads.

In England (according to the R.I.B.A.) on the other hand, pointed heads are considered to be preferable (fig. 70B, right-hand rammer). The Building and Public Works Laboratory has produced an interesting design for a rammer (fig. 70 C), which has certain advantages: in the first place it is easily made from a beam; in addition much smoother external surfaces are obtained if it is used with the higher of the two vertical sides against the side-panel of the form.

How should a rammer be used? Three builders work their way together down the length of the form, one on each side with this particular rammer and one in the middle with an ordinary rammer. The outward pressure on the formwork should be reduced, since the first two builders in compacting the earth against the side-panels increase the efficiency of formwork. A rammer with a sliding head (fig. 70 D) tested in the United States is shown for information but in our view is of no particular merit.

The way in which the rammer is used will of course dictate the quality of the finished rammed earth. The South Dakota State College tested three ways of using the same rammer on 5 blocks for each trial:

- 1) The first five blocks were compacted by releasing the rammer from a height of 10 cm without exerting any pressure on it;
- 2) The second set of five blocks was compacted by releasing the rammer from a height of 15 cm at the same time exerting very slight pressure with each blow;
- 3) The third set of five blocks was compacted by

Rammers

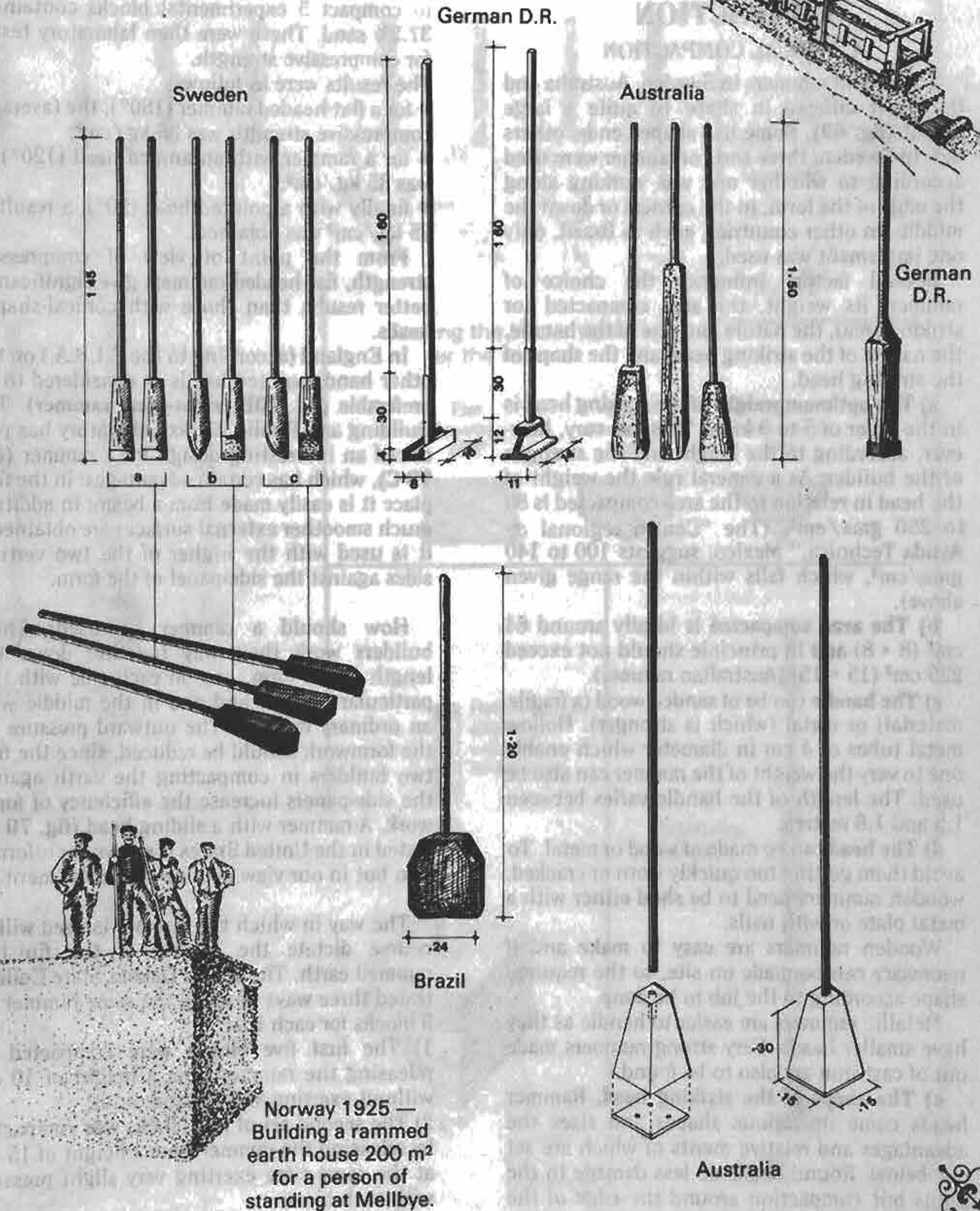
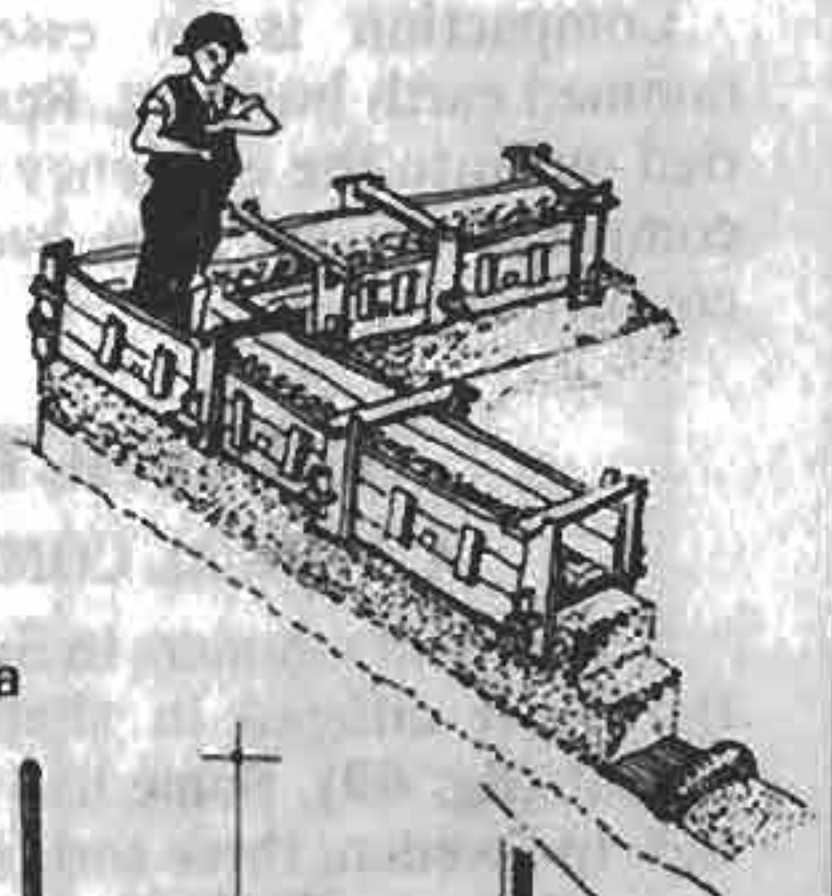

Testing Rammers

fig A¹

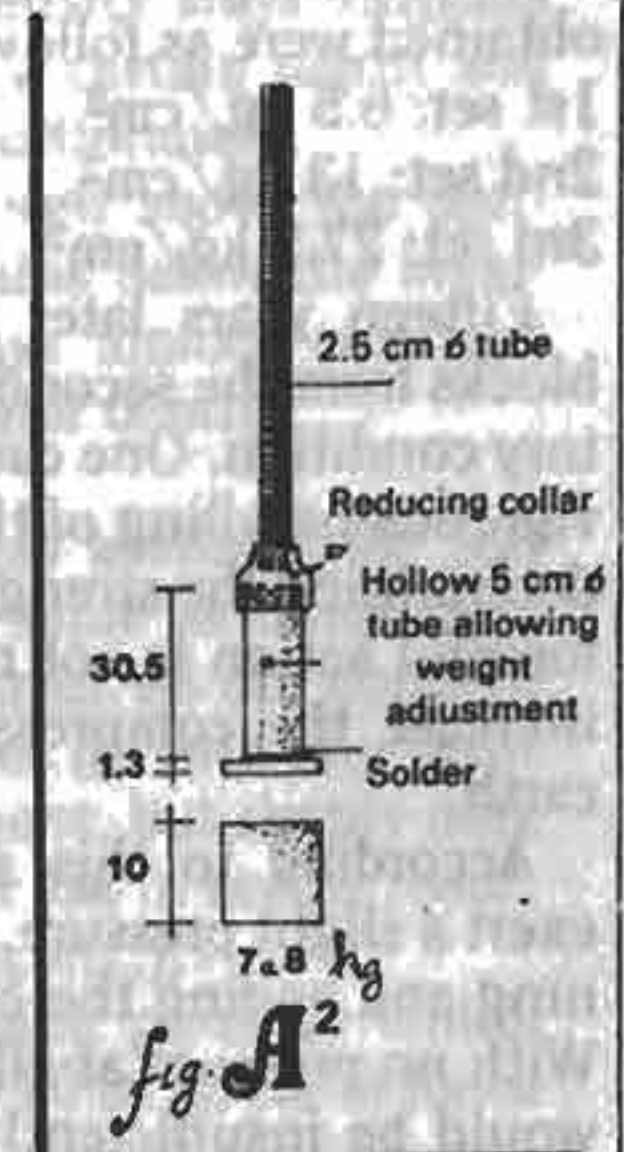
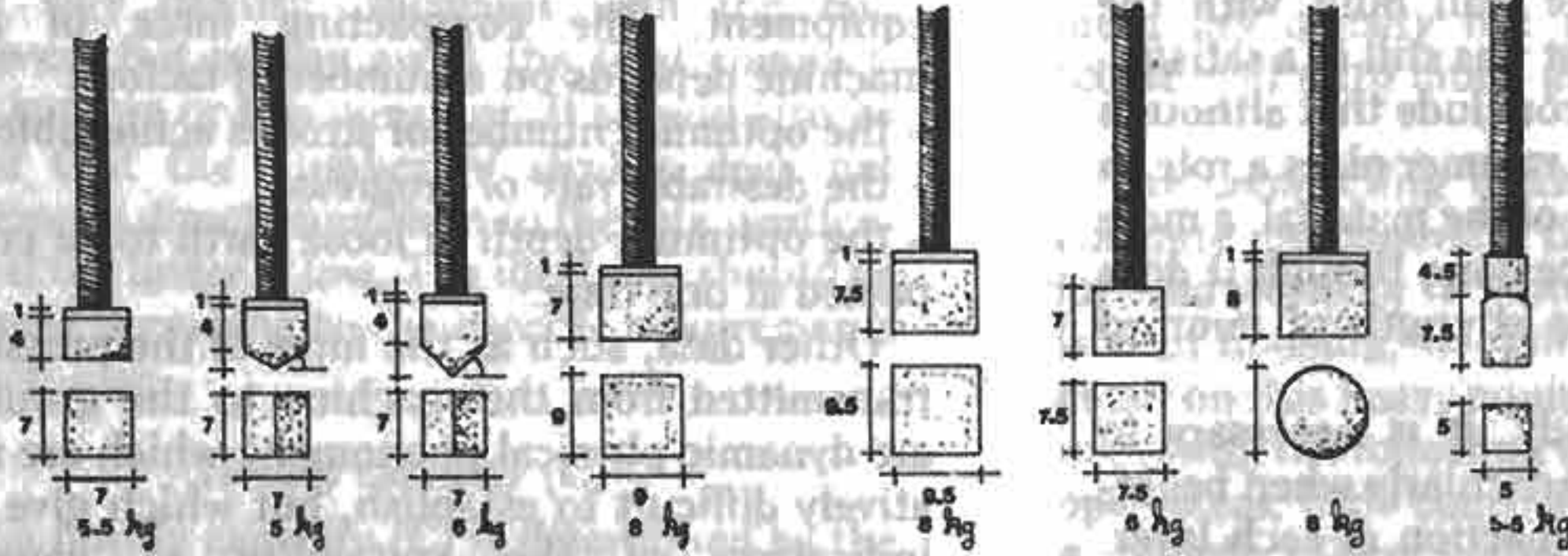

fig A²

Testing the best shape for the rammer

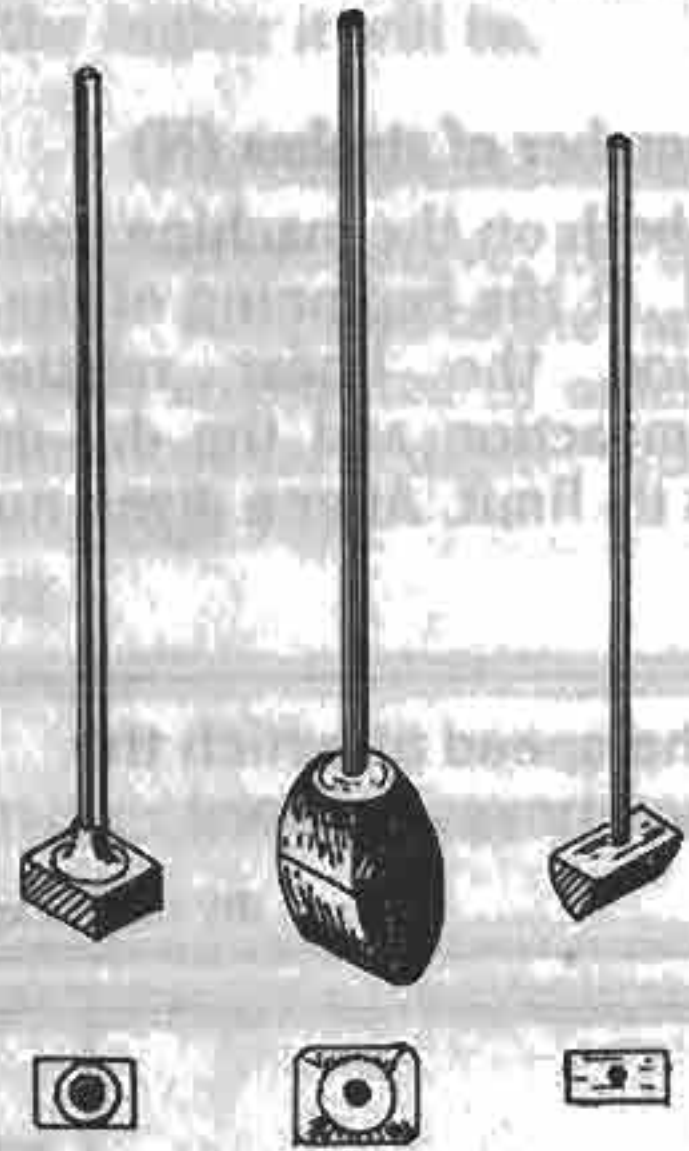

fig B

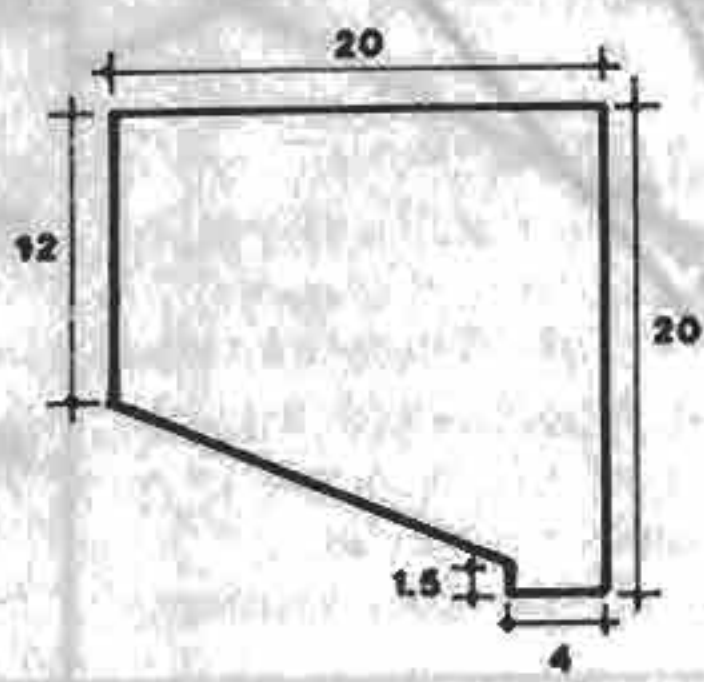

fig C

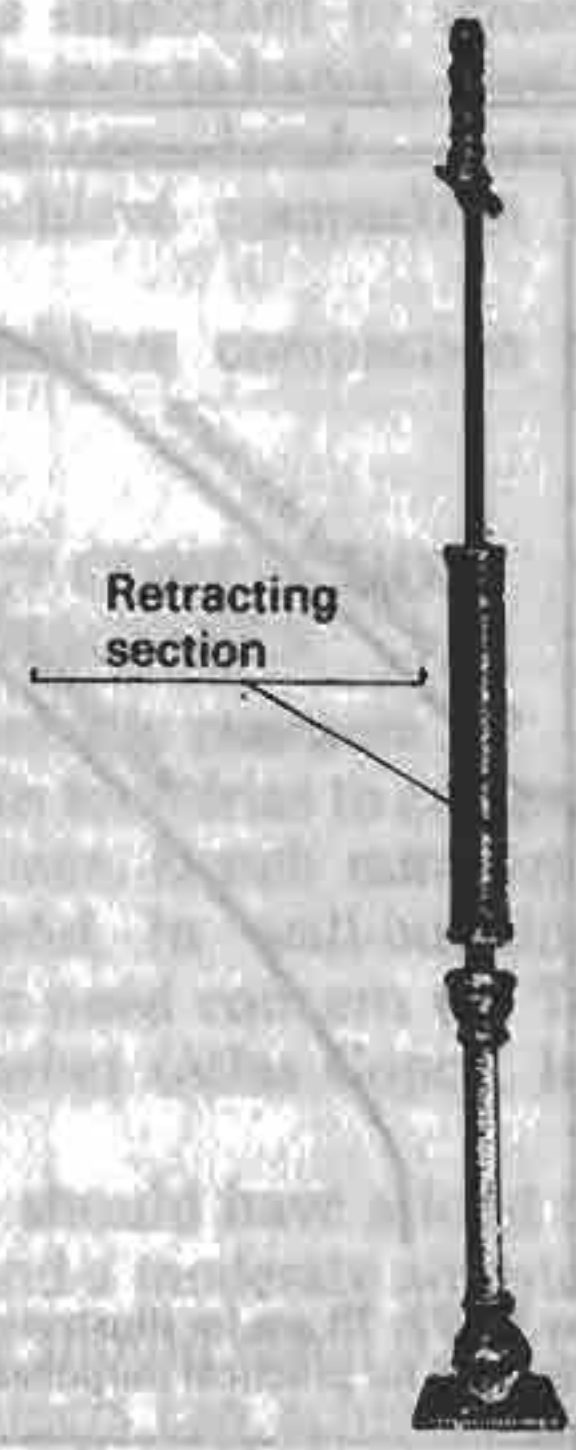
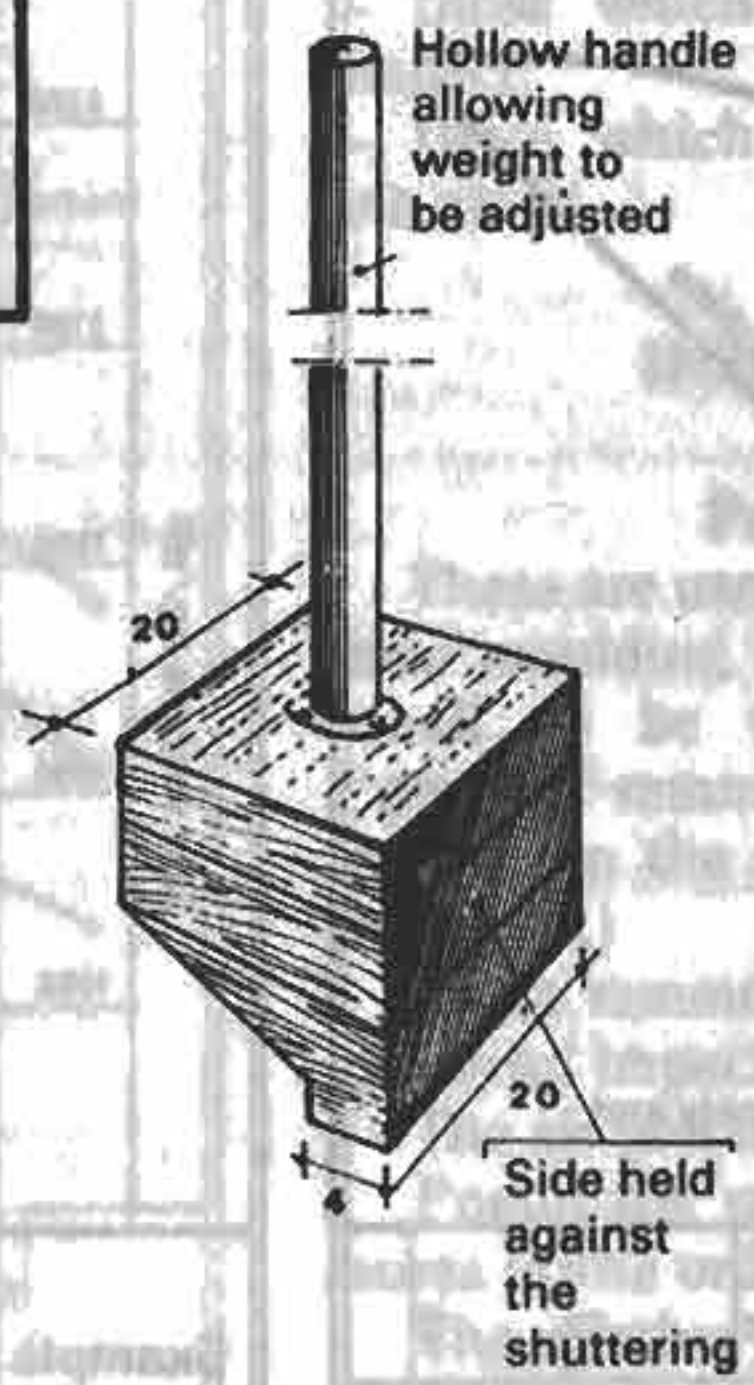

fig D

releasing the rammer from a height of 30 cm and exerting the maximum possible pressure.

The three sets of 5 blocks were then tested for compressive strength.

The average compressive strength results obtained were as follows:

1st set: 6.5 kg/cm²

2nd set: 13 kg/cm²

3rd set: 27.5 kg/cm²

Fifteen years later the wall built with the blocks from the second set was still in a satisfactory condition. One can conclude that although vigorous handling of the rammer plays a role in determining the strength of the material, a more forceful action is not necessary, though it does increase the compressive strength of rammed earth.

According to this study, it is necessary to exert a slight pressure, particularly when beginning and ending the compaction of each layer. With no pressure at all, the bottom of the layer would be insufficiently compacted. Resistance to erosion probably depends on the compaction density.

Manual rammers exert an average static pressure of 0.10 to 0.25 kg/cm² and usually allow the compaction of a layer of earth 10 cm deep. To avoid any risk, however, and to ensure that the compaction is even, it is advisable to reduce

this to 5 or 7 cm of compacted earth. When the rammer ceases to leave any impression on the surface of the tamped earth, and when the sound produced changes to a dull thud, the compaction is complete.

B. MECHANIZED COMPACTION

It is indispensable to carry out trials on site in order to be able to make the correct choice of equipment. The compacting force of any machine depends on a number of factors:

- the optimum number of strokes achievable;
- the desirable rate of progress;
- the optimum depth of loose earth to be compacted at one time.

Other data, such as the force of the pressure transmitted from the machine to the ground, are dynamic physical phenomena which are relatively difficult to establish, but which give an indication of the suitability of various machines.

The number of strokes (N)

This depends both on the machine used (fig. 71) and the soil. At the beginning of the compaction operation the linear relationship between the compaction and the dry density obtained attains its limit. After a given number

FIGURE 71:

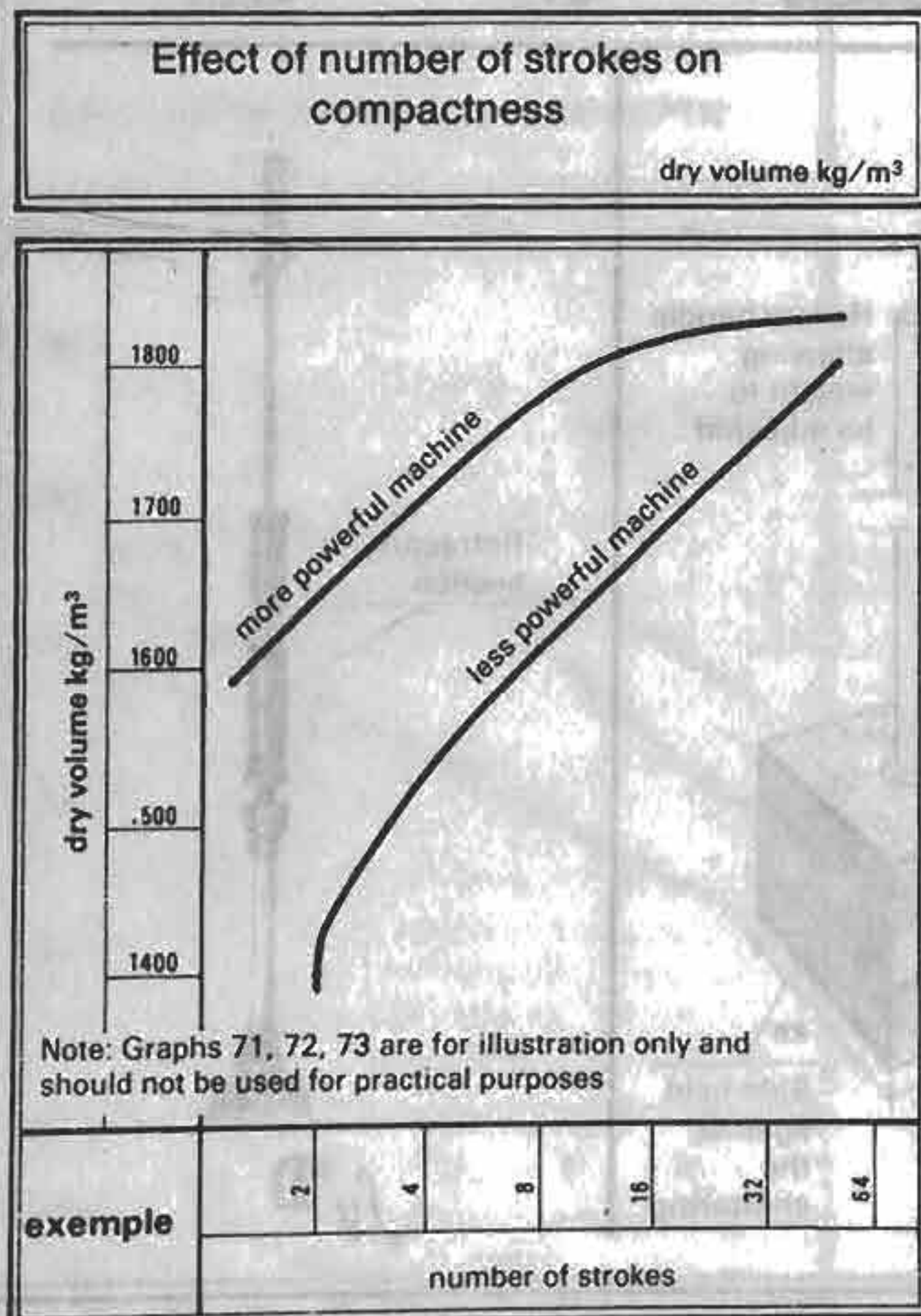
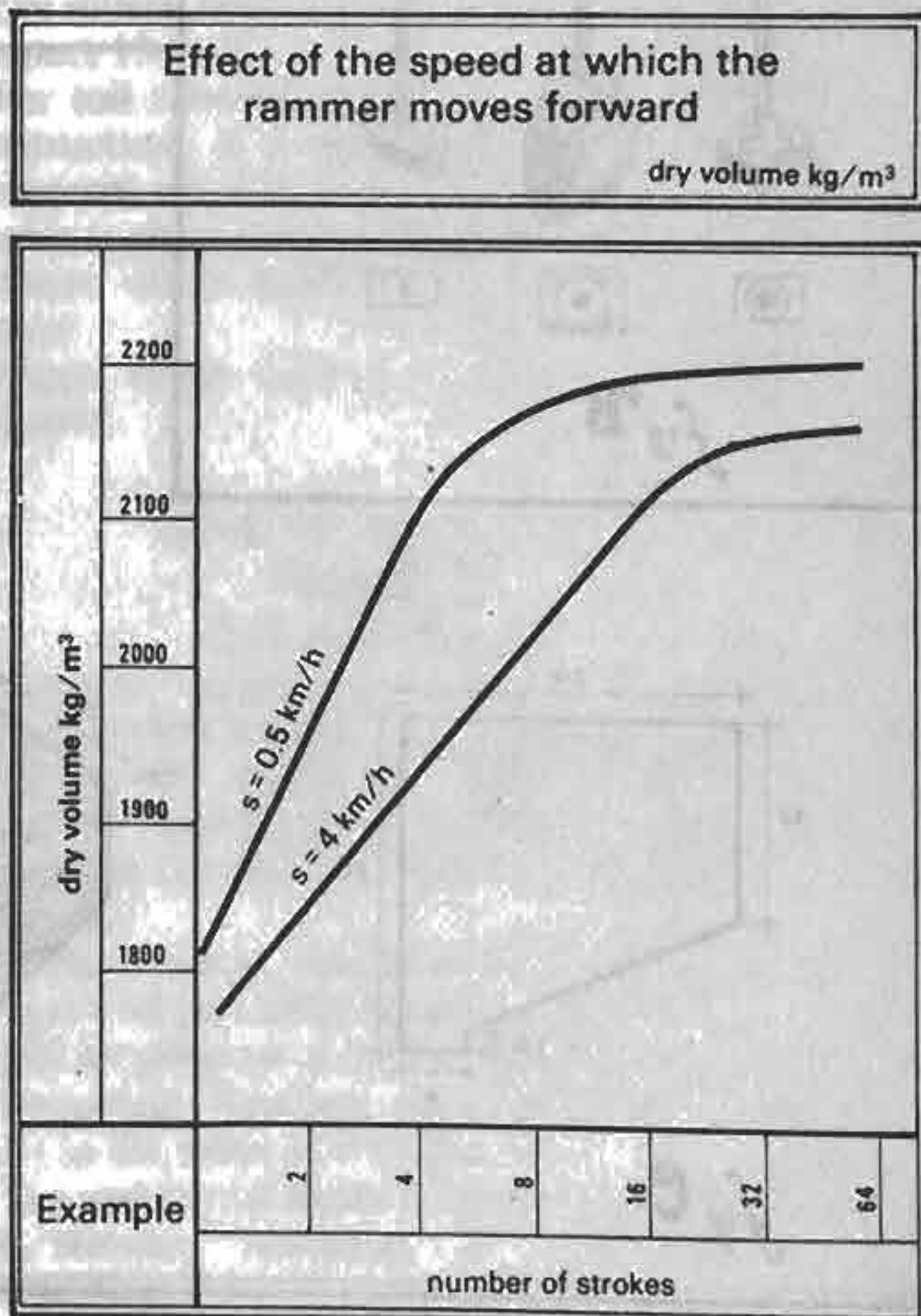

FIGURE 72:



of strokes, further compaction achieves no purpose. To obtain greater dry density, a more powerful machine is needed. The right hand curve and the minimum number of strokes can only be determined by experience.

The rate of strokes (R) (fig. 72)

The number of strokes needed to attain a good "dry density" increases with the rate achieved, but in any event the final compactness is more or less constant. It should also be noted that the number of strokes does not increase in direct proportion to the rate, particularly if the latter is low. The ideal rate should be assessed according to the specific requirements of each case.

Hourly capacity (C)

The hourly capacity (C) is determined by the equation : $R / \text{minimum } N$. The greater this result, the higher it will be.

The compactness curve

The compactness curve, i.e. the variation in "dry density" compared to the variation in depth of the earth compacted in order to assess the maximum loose earth depth, produces interesting results (fig. 73).

FIGURE 73:

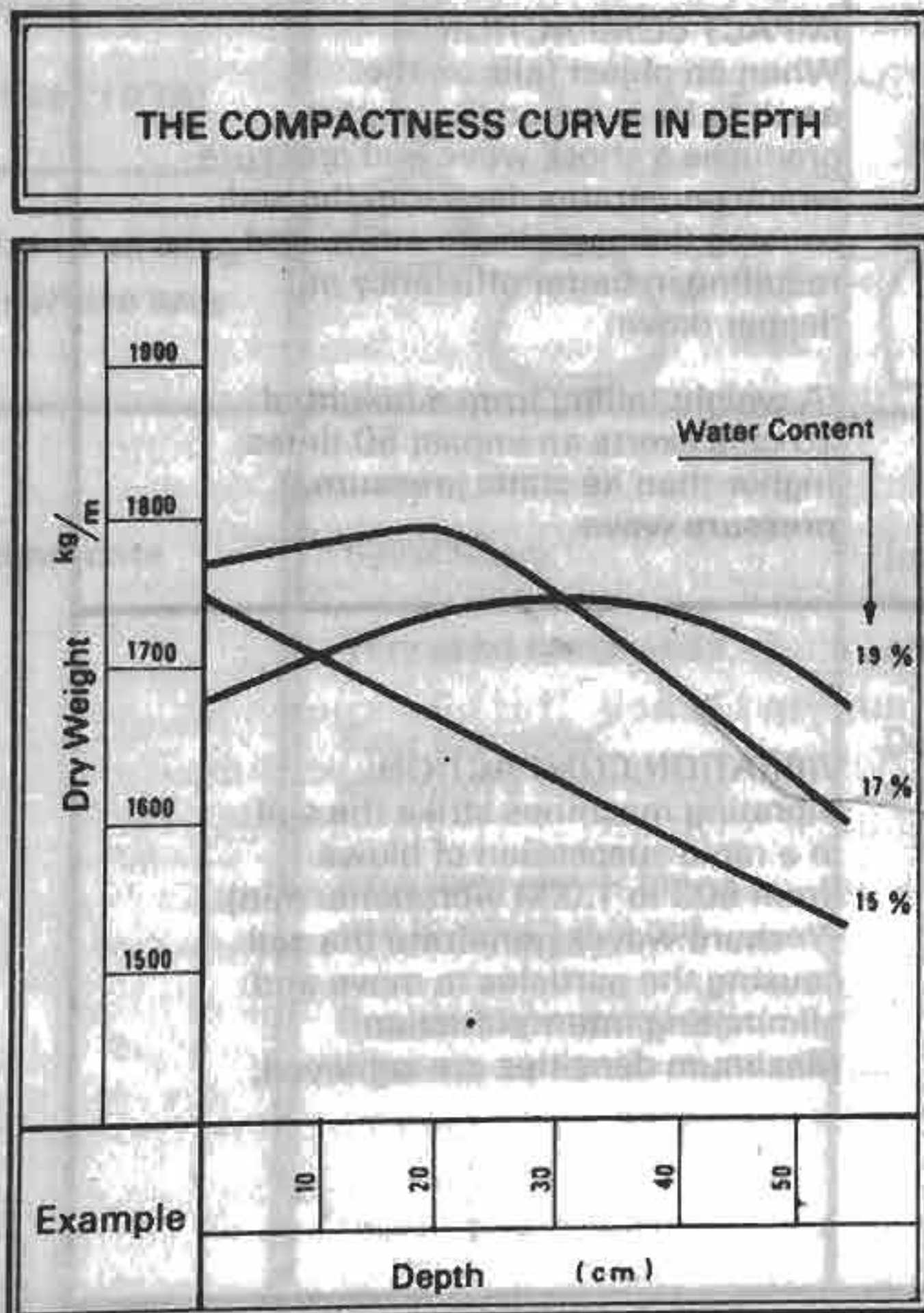

- 1) If the water content is lower than the optimum, the dry density decreases almost proportionately with the depth.
- 2) If the water content is greater than or equal to the optimum, the dry density stays virtually constant (curve = 0) until a certain depth and then decreases almost proportionately.
- 3) If the water content is well above the optimum, the dry density remains below the maximum dry density but stays almost constant (curve = 0) until much greater depths.

The compacting machines available for soil concrete are generally the same as those used for road works or in foundaries. As our concern is with housing, we will not go into any great detail on this heavy equipment, but simply note in passing the following (for use in access roads, open areas, little courtyards, etc.):

- smooth rollers using static pressure which can compact approximately 20 to 25 cm of loose earth in 8 to 15 runs;
- vibrating rollers with a linear load of 10 to 25 kg/m running at a rate of 1200 to 3600 cycles/minute at variable amplitude;
- ridged rollers exerting pressures of 7 to 14 kg/cm² on earth layers of maximum 20 cm. They have the advantage of compacting the earth from below and of rising gradually until the earth layer is complete.
- tyre rollers: with a load of 1 or 2 tons they can compact 15 to 25 cm of earth in 10 to 15 runs.

For soil concrete and poured earth used for construction, it is important to choose light equipment which is easy to handle. Two types of machines should be considered:

- those which achieve compaction through impact;
- those which achieve compaction through vibration.

IMPACT COMPACTION MACHINES

Pneumatic rammers

These are used in foundries to compress sand into moulding frames. Bench rammers are too small to be useful in wall-building; only "ground" rammers need concern us. There are several on the market (Atlas Copco, Ingersoll-Rand etc.)

These rammers should have a long stroke, a powerful impact and a moderate air intake.

The air pressure should reach 5 kg/cm².

Pneumatic rammers can achieve static pressures in the order of 0.45 kg/cm².

The number of strokes varies between 400 to 700/minute, resulting in very vigorous compacting.

Walls compacted with pneumatic rammers have been observed to display remarkably uniform dry density, whereas manual tamping gives very irregular results.

Vibrating rammers

These achieve a static pressure of 0.05 to 0.10 kg/cm², but this disadvantage is compensated by a very high rate of strokes per minute (from 500 to 1000). The depth of compaction of the standard AASHO level reaches 30 cm and the weight lies between 60 and 100 kgs.

The stroke distance is small (35 to 40 mm) and the speed of advance in the order of 13 m per minute. In general 15 cm can be compacted in 4 passes. The result is approximately 7 m³/hour.

Not being very bulky, these machines can be used in certain types of formwork. Their weight makes them more suited to compacting floors, small open areas and so on. The results of the trials we have carried out on various pneumatic and vibrating rammers are summarized in table form (figs. 75 and 76).

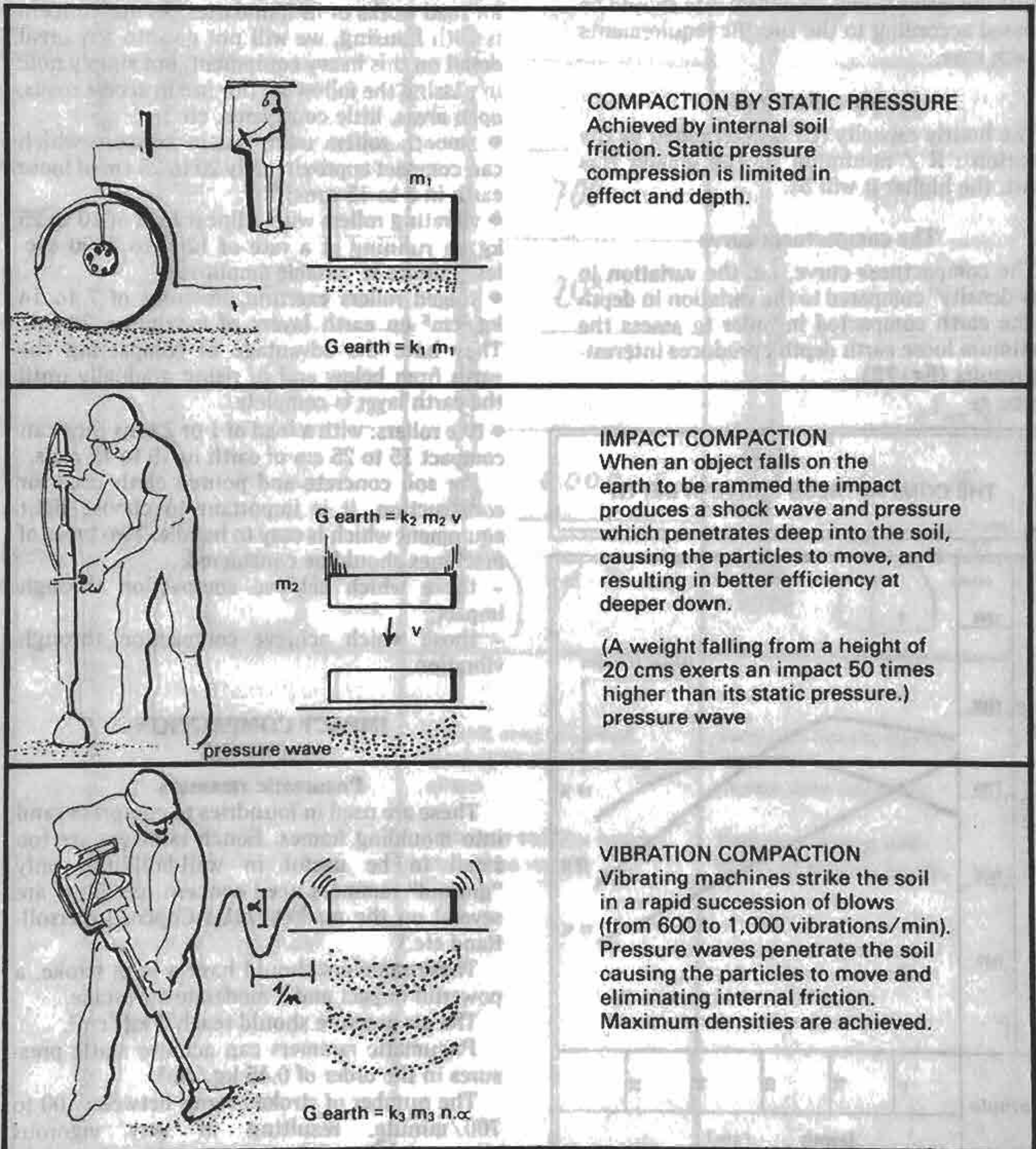

COMPACTION BY STATIC PRESSURE

Achieved by internal soil friction. Static pressure compression is limited in effect and depth.

IMPACT COMPACTION

When an object falls on the earth to be rammed the impact produces a shock wave and pressure which penetrates deep into the soil, causing the particles to move, and resulting in better efficiency at deeper down.

(A weight falling from a height of 20 cms exerts an impact 50 times higher than its static pressure.)
pressure wave

VIBRATION COMPACTION

Vibrating machines strike the soil in a rapid succession of blows (from 600 to 1,000 vibrations/min). Pressure waves penetrate the soil causing the particles to move and eliminating internal friction. Maximum densities are achieved.

FIGURE 75





Type	Pneumatic rammers		
Name	<i>Atlas Copco</i>	<i>Atlas Copco</i>	<i>Outipervet</i>
Appellation	<i>RAM 30</i>	<i>RAM 20</i>	<i>OPFL 3</i>
Weight (kg)	<i>18,5</i>	<i>10,9</i>	<i>14,5</i>
Height (m)	<i>1,23</i>	<i>1,31</i>	<i>1,20</i>
Frequency (no. of strokes/min)	<i>440</i>	<i>700</i>	<i>400</i>
Travel (mm)	<i>284</i>	<i>203</i>	
Consumption	<i>0,8 m³ air / mn</i>		<i>1,1 m³ air / mn</i>
Price (1976)	<i>3400 F</i>	<i>2000 F</i>	<i>1650 F</i>
Size of striking surface area	  ϕ <i>145</i> <i>mm</i>	 ϕ <i>75 mm</i>	 <i>Carre 70x70</i> <i>mm</i>
Comments	<p>Satisfactory.</p> <p>Very good compaction.</p> <p>Easy to handle, although a little heavy.</p> <p>Excessive power for use to which it is put.</p> <p>See our experience at Vignieu.</p>	<p>Impact area too small, leading to a puncturing effect.</p> <p>Different striking heads should be tested.</p>	<p>Easy and light to handle.</p> <p>Impact area too small.</p> <p>Requires testing with different striking heads.</p>

FIGURE 76

Type	Pneumatic Rammers		Vibrating Pick Hammers	
Name	<i>George Renaud</i>	<i>Wacker-France</i>	<i>Wacker-France</i>	
	<i>F 18</i>	<i>BS 50</i>	<i>BS 20</i>	
Weight (kg)	<i>10,8</i>	<i>55</i>	<i>26</i>	
Height (m)	<i>1,14</i>	<i>1,16</i>	<i>1,02</i>	
Frequency (no. of strokes/min)	<i>600</i>	<i>500-630</i>	<i>850-900</i>	
Travel (mm)	<i>163</i>	<i>45 Max</i>	<i>42 Max</i>	
Consumption	<i>0,8 m³ air / mn</i>	<i>1.2 l/h Mixture oil/petrol</i>	<i>1.2 l/h Mixture oil/petrol</i>	
Price (1976)	<i>1400 F</i>	<i>5000 F</i>	<i>4113 F</i>	
Size of striking surface area	 <p>Round ϕ 95 Square 100 x 100 130 x 130 Rectangular 25 x 78 35 x 120</p>	<i>320 x 280 mm</i>	Exchangeable	
Comments	Machine not tested. Looks suitable ... remains to be seen.	Too heavy to be handled within the formwork. Could be used for ground floor flooring — small squares — courtyards — patio ... etc.	Heavier than a pneumatic rammer and therefore not easy to use in a restricted space. Very small travel and high frequency could lead to too sudden a compaction and resonance vibration problems.	

These are to be avoided as their stroke distance is very small and their rate very high (approx. 800 strokes/minute). The compacting action which is too brusque often causes shifts in the layers already compacted and sets up

resonance vibrations. Moreover these machines weigh from 15 to 25 kg and are very tiring to handle. The rammer plates should be of a piece (in cast iron), since welded joints would not withstand the vibration.

FOUNDATIONS

As earth walls are thick, the width of the foundations undoubtedly has an impact on the cost of the building. Hence the importance of choosing the most economical technical solutions.

It will be recalled (fig. 77A) that the foundation must be sufficiently resistant to the stress produced by the building, must serve as a ring-beam, must be deep enough to be below frost-level (height H2) and must extend above the ground to form a footing (height H1 = 50 cm). In all cases good drainage is essential.

The materials which can be used for foundations include:

- cement (reinforced or not);
- brick, rubble, cement block etc. masonry;
- highly stabilized soil concrete, compacted or in brick form.

The top of the footing (fig. 77 B) should not project out from the wall to avoid rain water collecting and splashing off the wall. A groove 5 cm high by 3 cm deep creates a drip-stone as an additional precaution.

It is important to coat the bottom of the footing with a material capable of withstanding the capillary action of water, such as bitumen, asphalted felt, naturally water-proof materials such as latex or rubber, flat stones, slate etc.

The floor-boards of the ground-floor are laid directly on the footing or on independently-supported joists.

In order to economize on materials, various options are available (fig. 77):

D: Too wide a foundation and footing (source Dufournet CSTB).

E: Low-cost foundation (source Dufournet CSTB).

F: Floor-boards laid on independently-supported joists (source: Commonwealth Experimental Building Station - Australia).

G: More economical foundation (source: Commonwealth Experimental Building Station - Australia).

H: Shuttering difficult to realise (source: South Dakota State College, United States).

FORMWORK

The formwork, an essential element in rammed earth construction, is of prime importance in the use of the material and thus also in determining the cost of the building. Its design should be thought through in the minutest detail and should take account of all the points which are discussed below with the aid of illustrations each of which shows a particular type of formwork.

1) Rigidity

The formwork must be sufficiently rigid to withstand stresses much higher than those of concrete. There are two options:

- one consists in making the panels thick (by using 4 to 5 cm thick planks for example);
- the other consists in bracing lighter panels (by doubling up putlocks etc., or by incorporating a reinforcing framework).

The plywood panels we used at Vignieu were 15 mm thick which proved insufficient; they

bulged by 1 cm between vertical posts 65 cm apart. The cuts made into the base of the panels weakened them.

2) Stability

The vibrations caused by mechanical tamping must be taken into account as they can dislodge the whole formwork. Tamping more on one side than on the other could also dislodge it. To preserve its stability, it should overlap the lower course by between 15 and 20 cm (fig. 89 L). The formwork on wheels illustrated has a good overlap of 19 cm. The same applies to the vertical overlap with the previous section on the same course.

Setting up the external bracing which we had to use at Vignieu was a lengthy process and lost us a good deal of time. As a solution it is to be avoided.

FOUNDATIONS

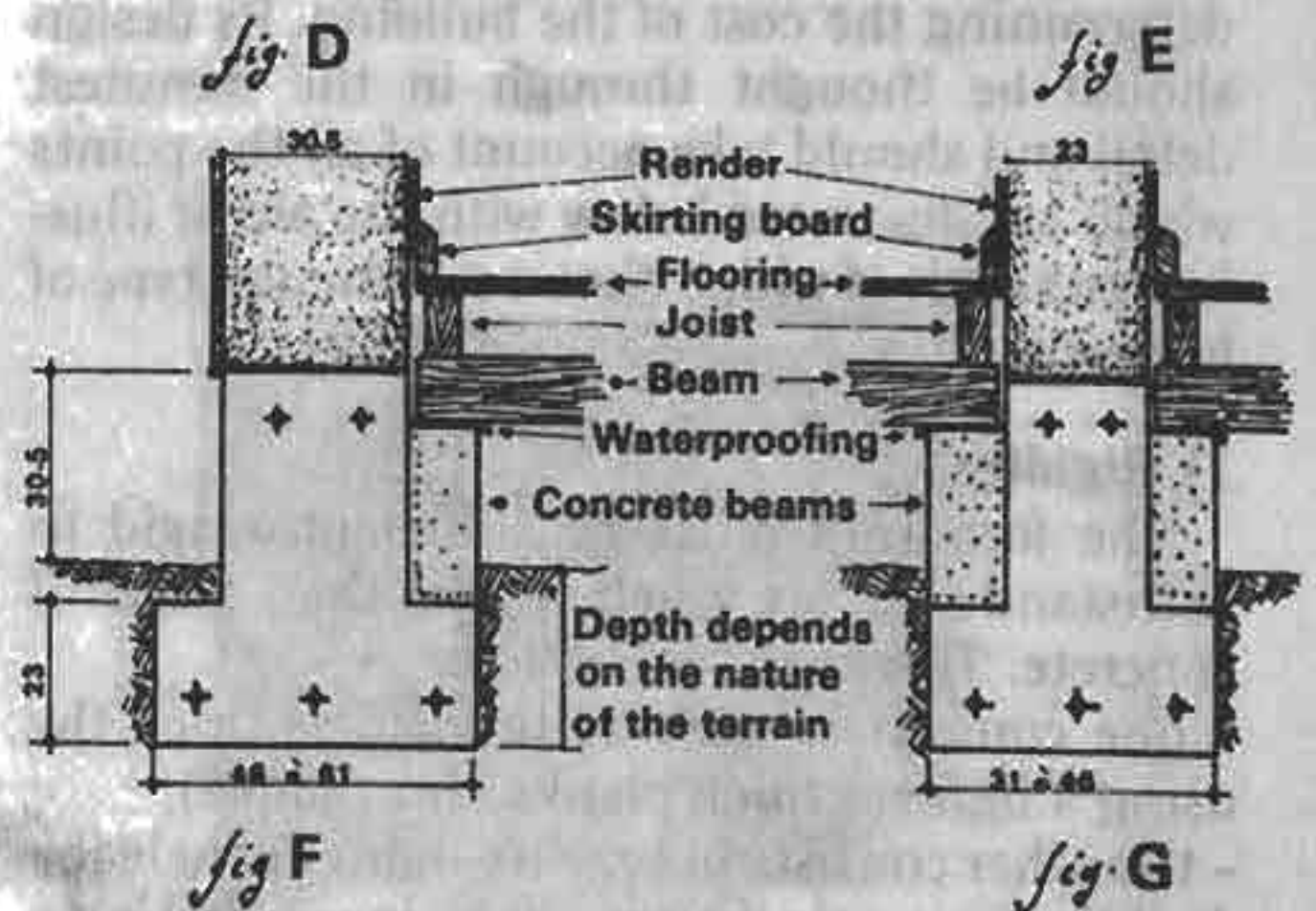
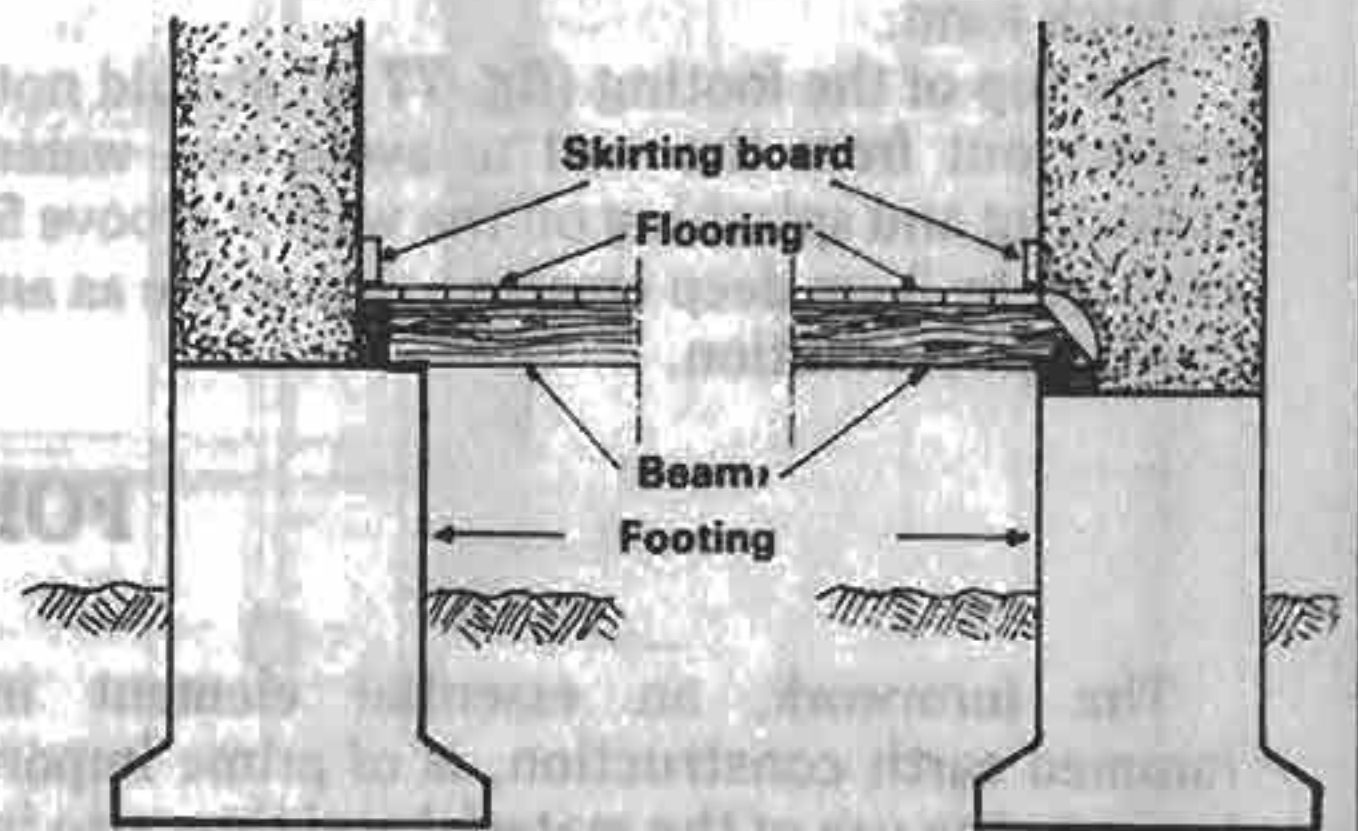
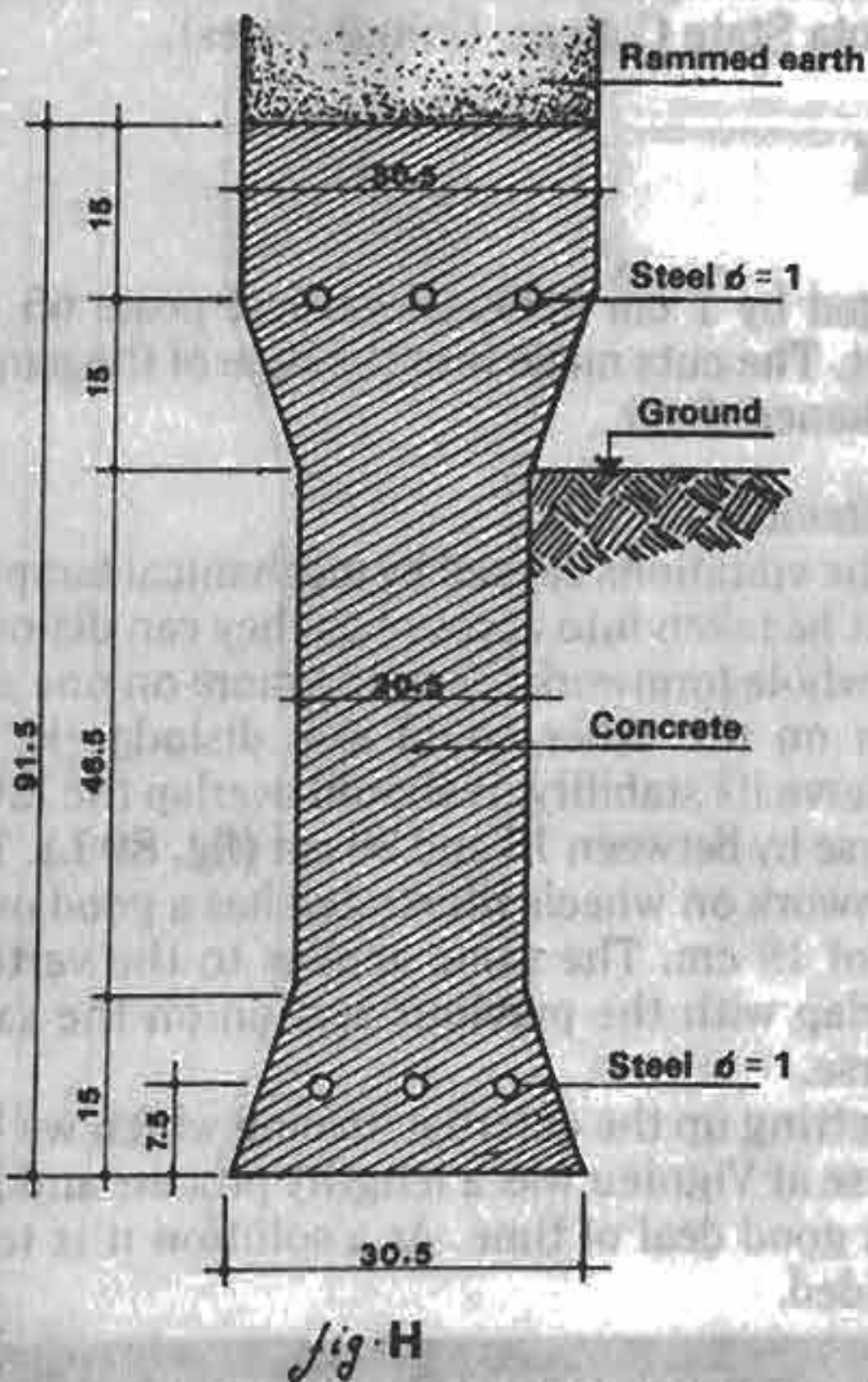
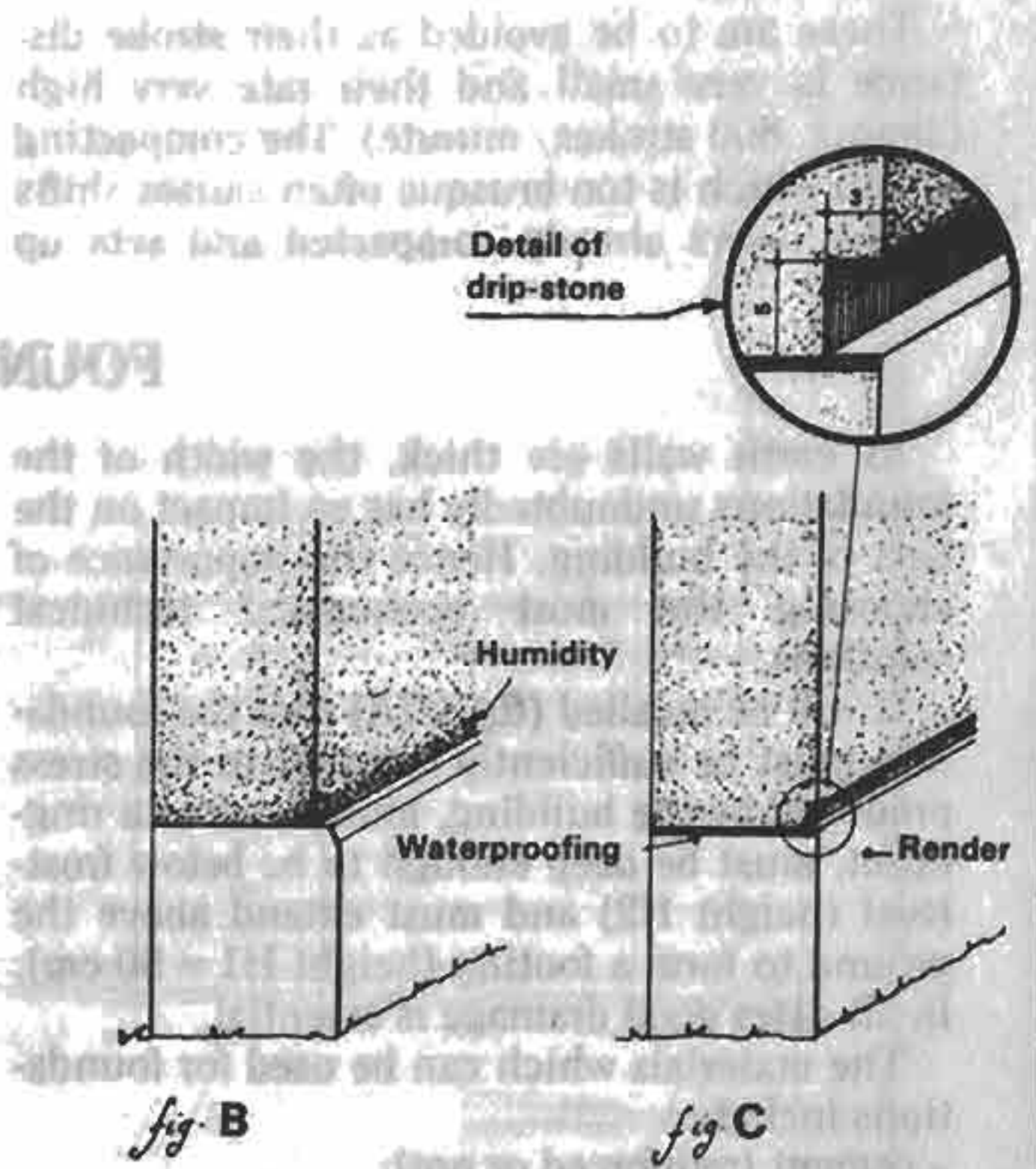
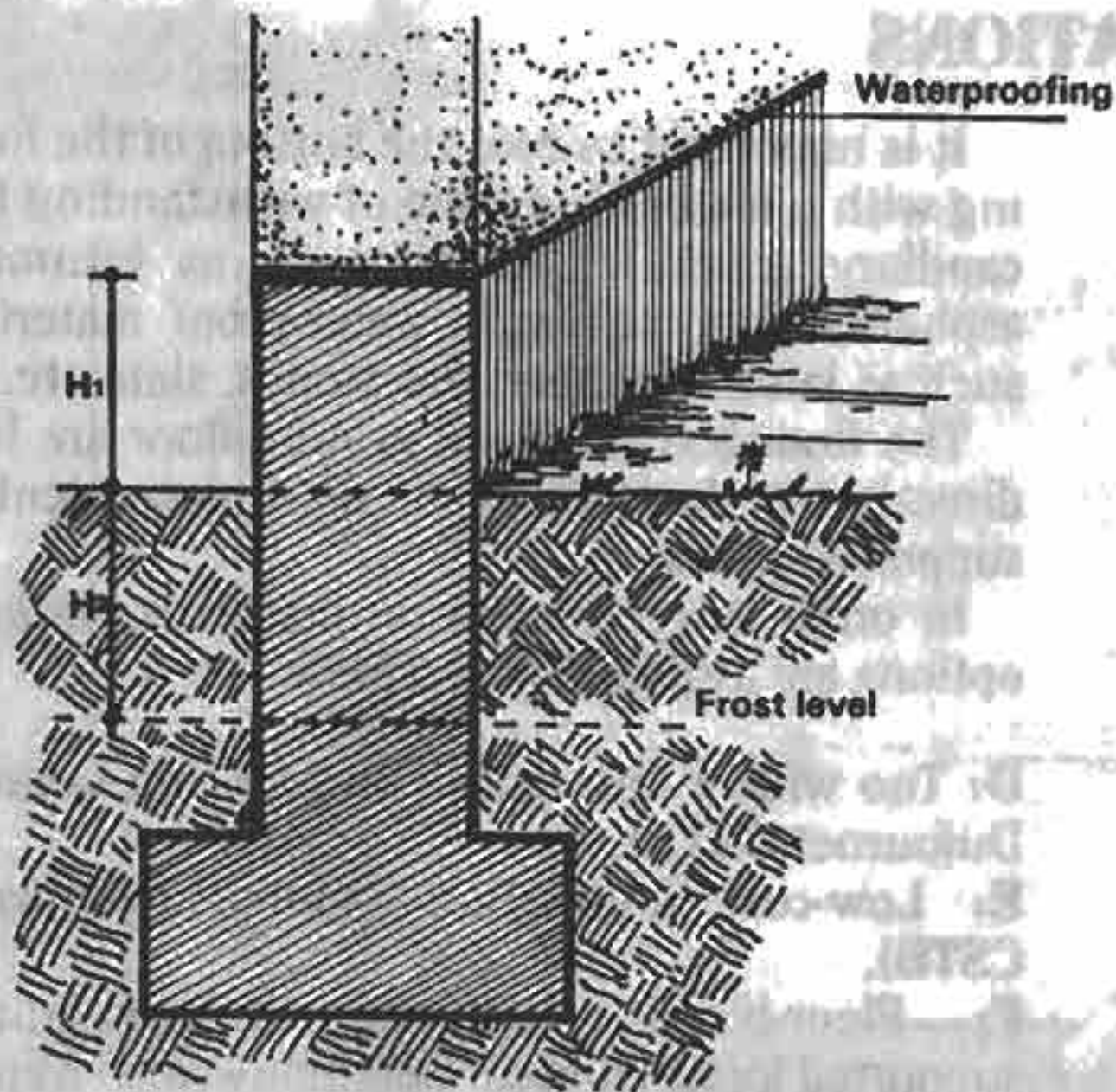

The formwork used at Vignieu

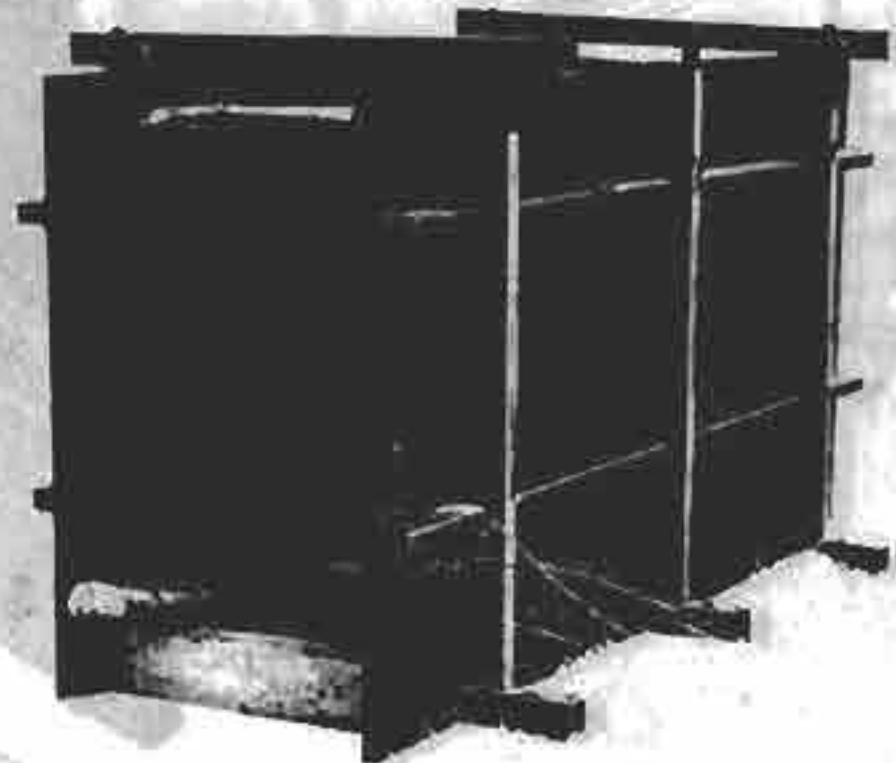
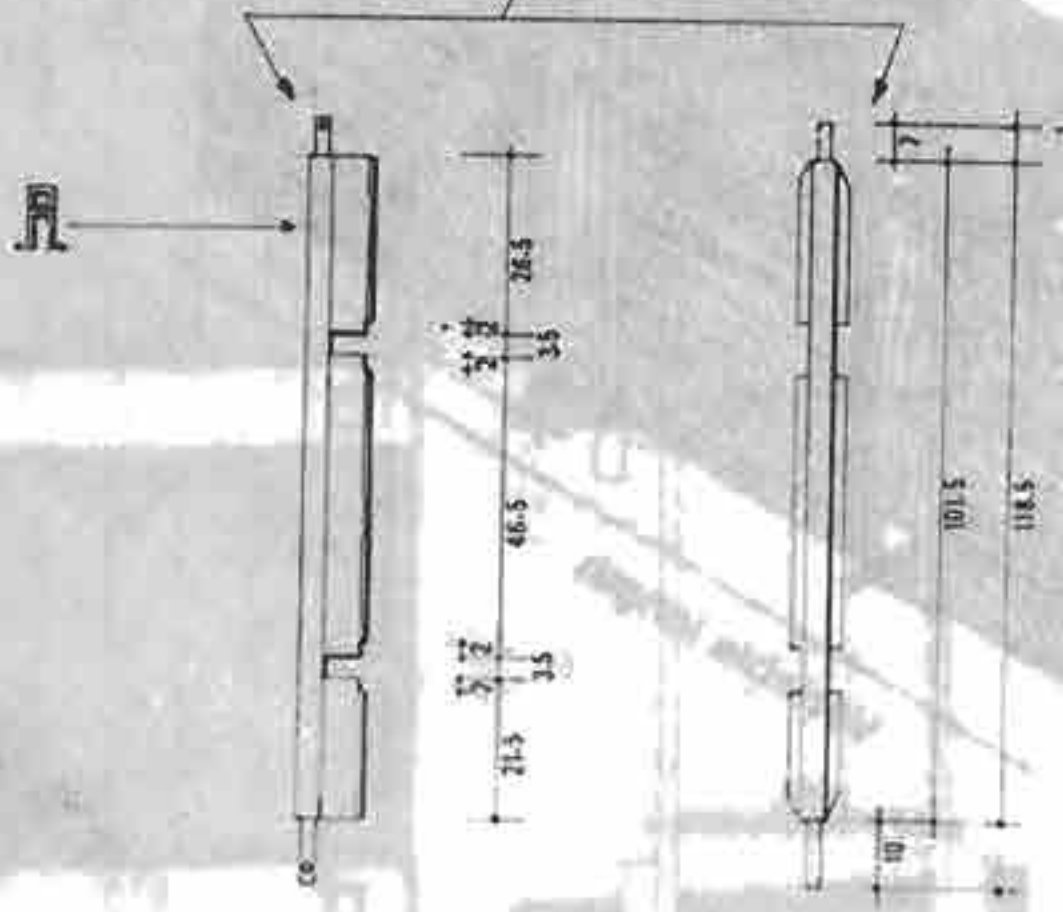
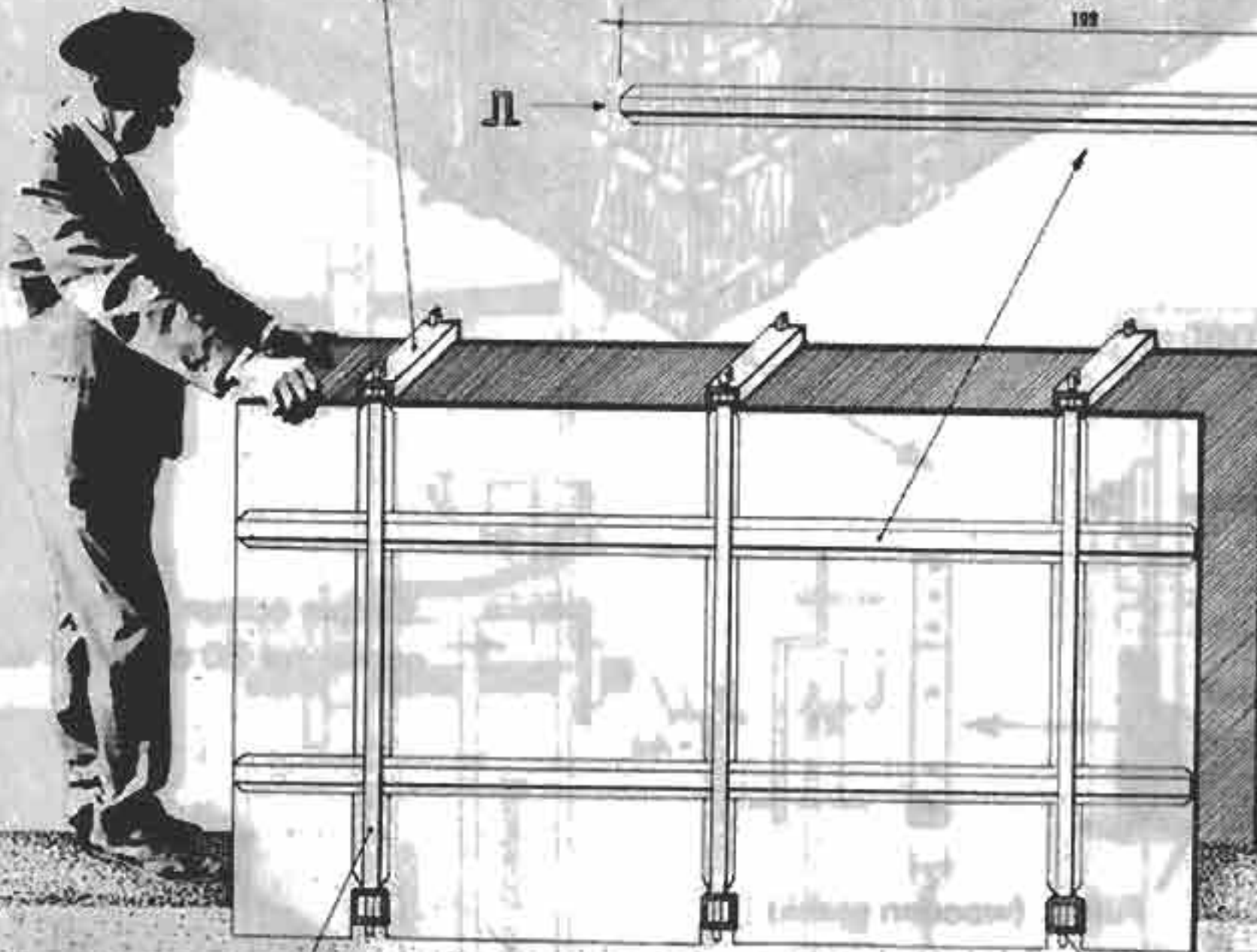
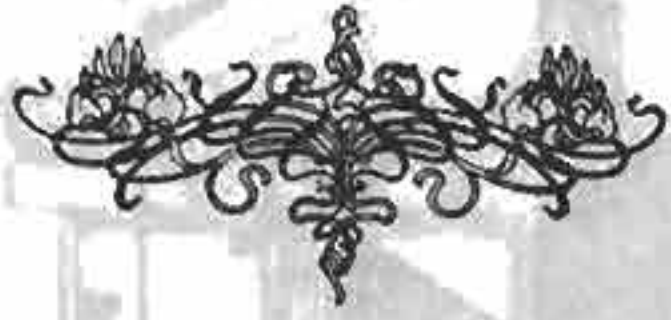
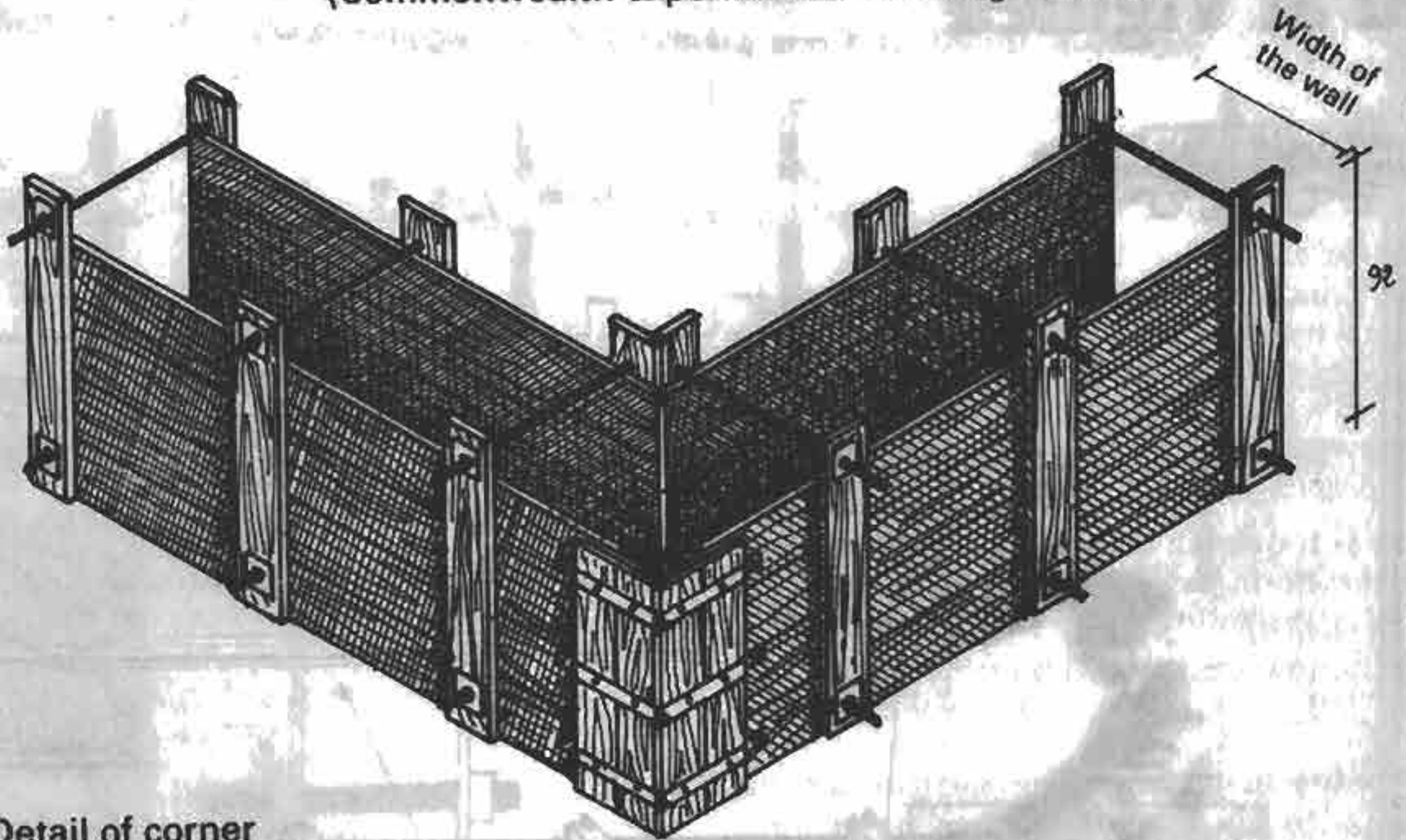

FIGURE 78:

A

Type of Shuttering : Traditional Australian shuttering
Document Reference : "Earth wall construction" by G.F. Middleton
(Commonwealth experimental Building Station).



Detail of corner

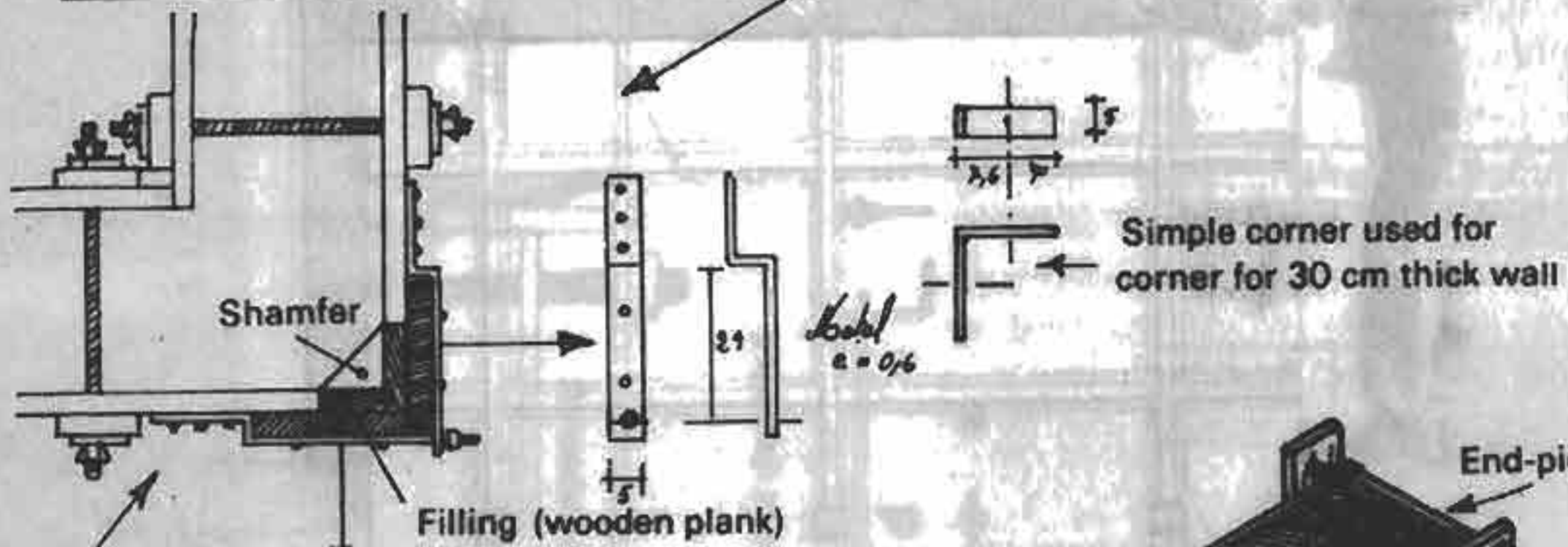

Corner system allowing for 50 cm walls

Spacing Sticks

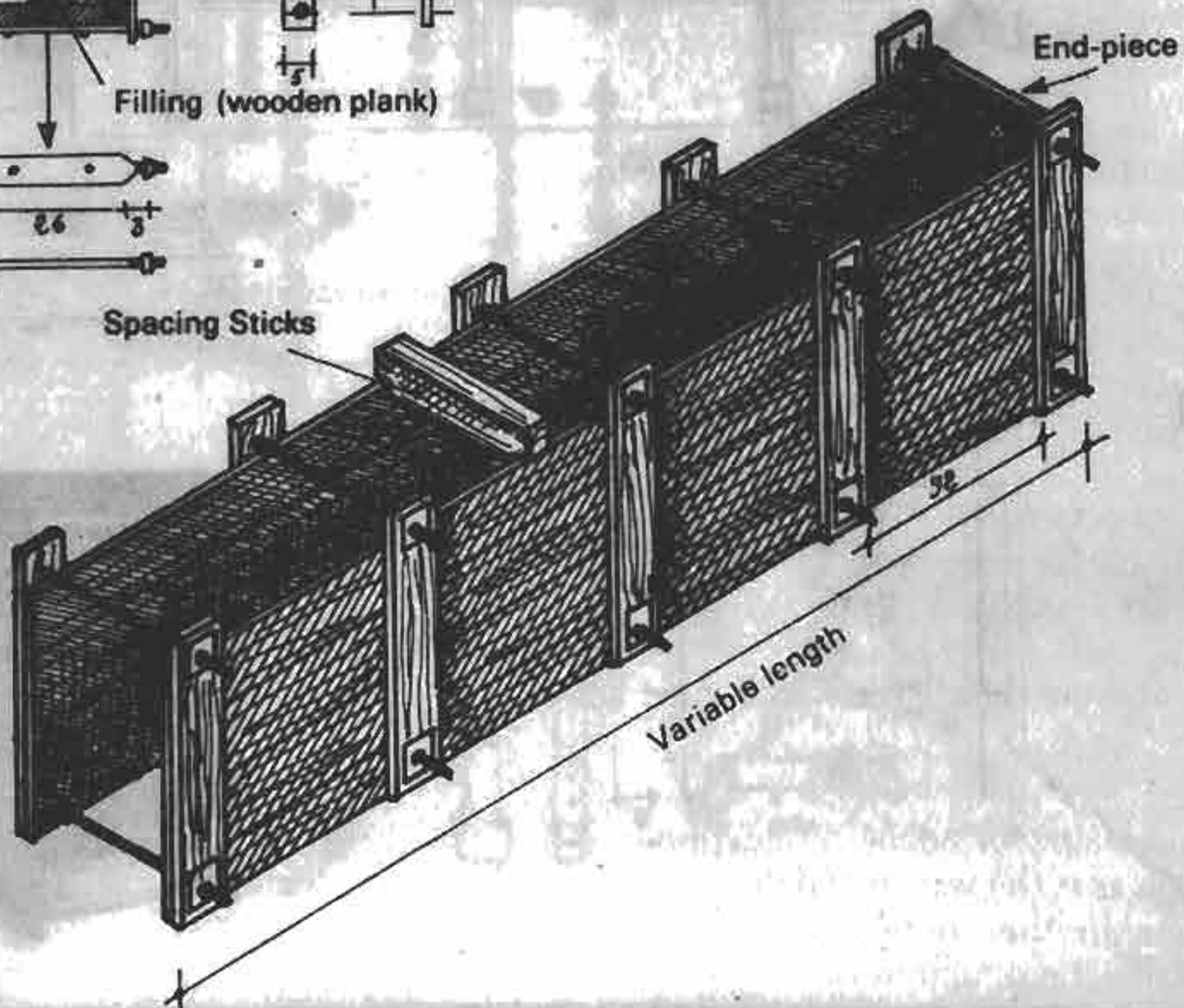

FIGURE 79

Type of formwork : derived from traditional formwork with independent shuttering for corners

Usage : seems to have been used on site

Document reference : "Jordhusbygge" C.O. Lindberg and K.G. Molin (Sweden)

B

1950

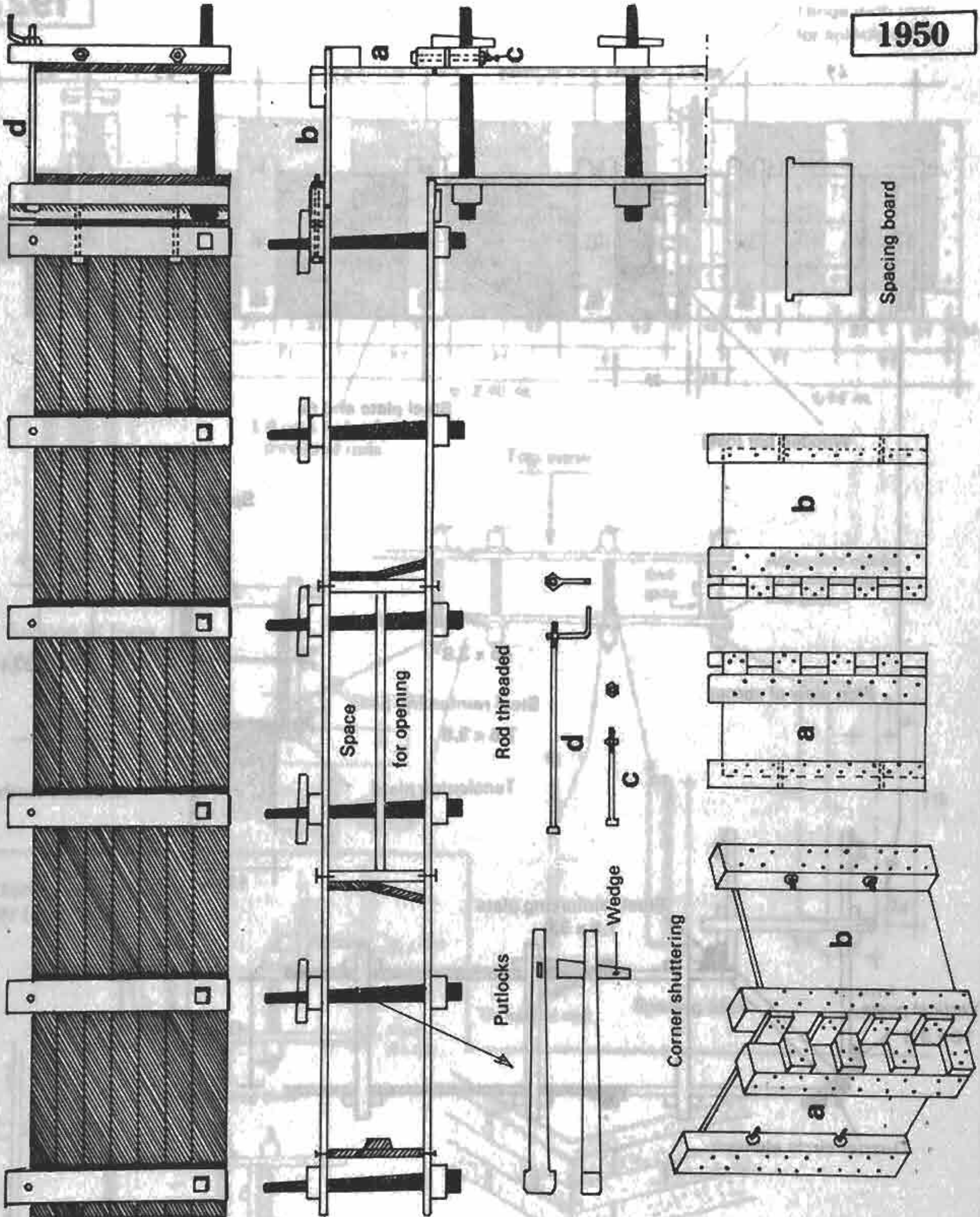

FIGURE 80

Type of formwork : Shuttering with wires as upper and lower transverse ties
 Usage : Used for the DSIR project
 Document Reference : "Building in Cob, Pisé, and Stabilized Earth"
 C. Williams-Ellis and J & E Eastwick Field

C

1927

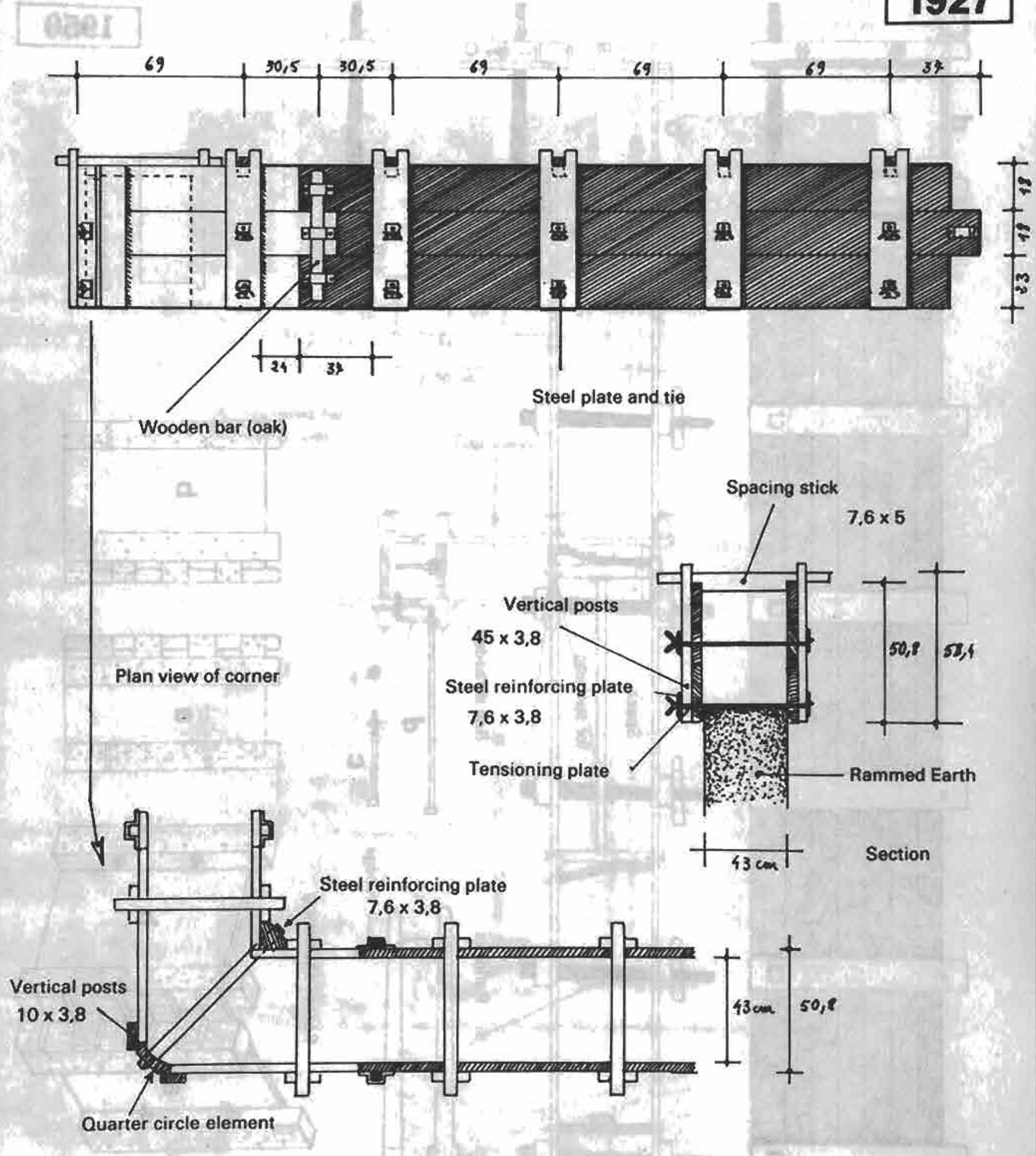

FIGURE 81

D

Type of Formwork : Hinged
 Usage : Has been used experimentally
 Document Reference : "Rammed Earth Walls" (USA) South Dakota State College

1959

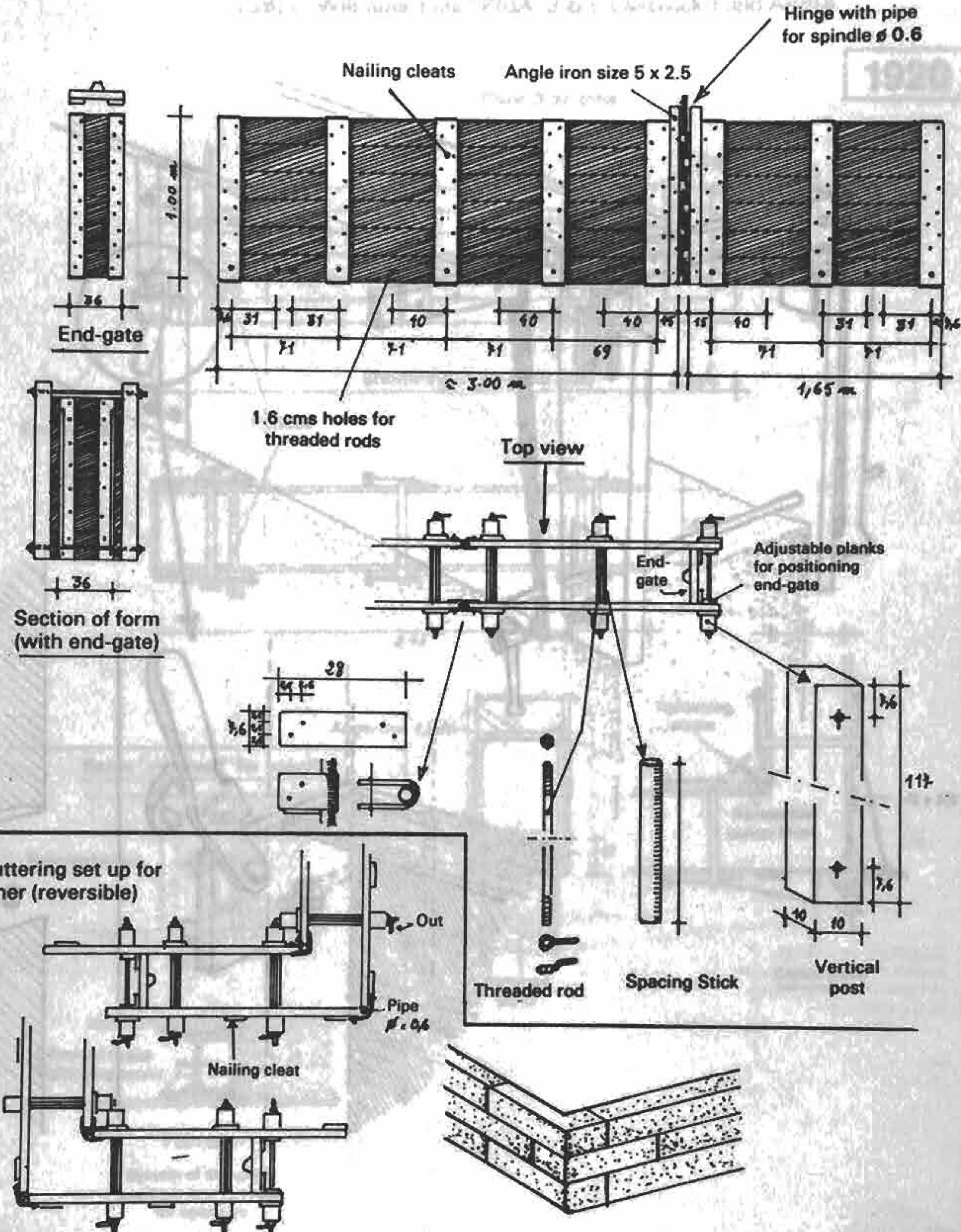

FIGURE 82

E

- Type of Form** : Screw-clamp designed by Ernst May
Usage : Used in Nairobi project (23 to 61 cm thickness)
Documentary Reference : "Building in Cob, Pisé and Stabilized Earth" C. William-Ellis, J & E Eastwick-Field

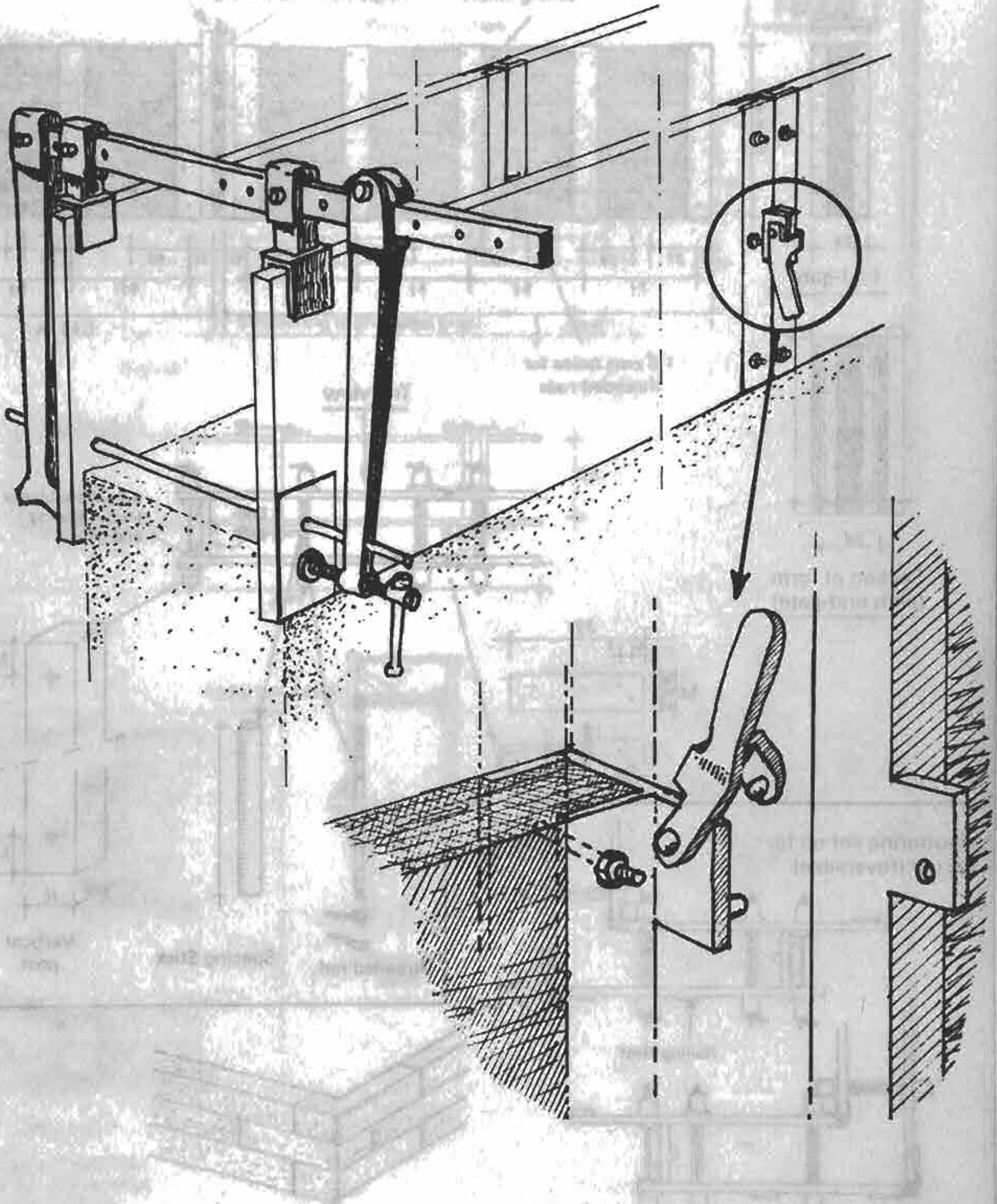

FIGURE 83

Type of Form : Wooden formwork derived from traditional system with added corner piece

Usage : Has been tested in a London park and successfully used in a small farm in Surrey in 1920.

Document Reference : "Building in Cob, Pisé, and Stabilized Earth"
(GB) C. Williams-Ellis FRIBA, J & E Eastwick-Field ARIBA

F

1920

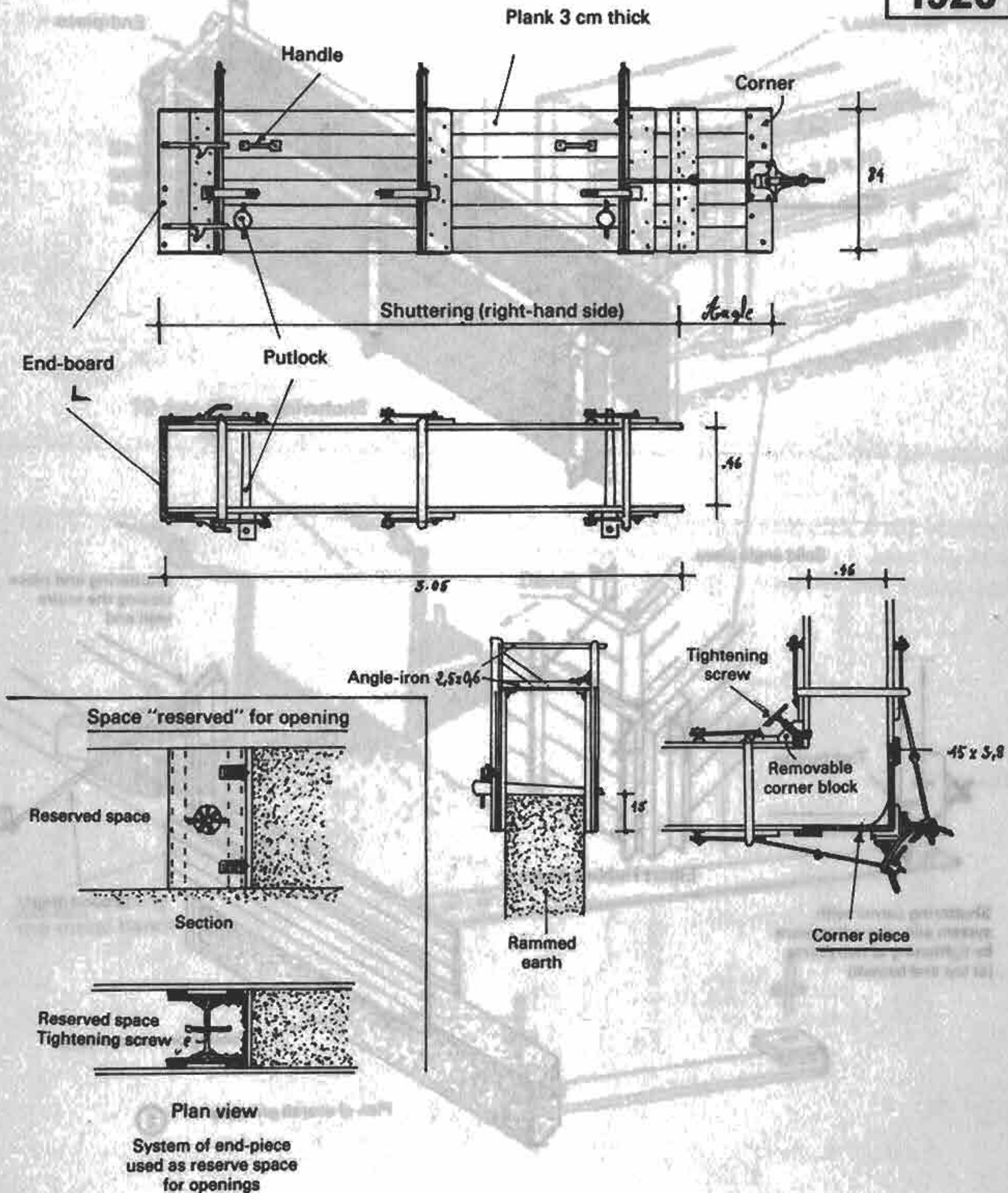

Type of Form : Wooden formwork with metal angle irons serving as vertical posts (1) and with end-piece allowing for the end of the wall to be shuttered all the way up the wall (2).

Usage : (1) Designed by Hubbell, seems to have been successfully used experimentally by the Standards Office.

Document Reference : "Rammed Earth House" by Anthony Merril (U.S.A.)

1941

OSER

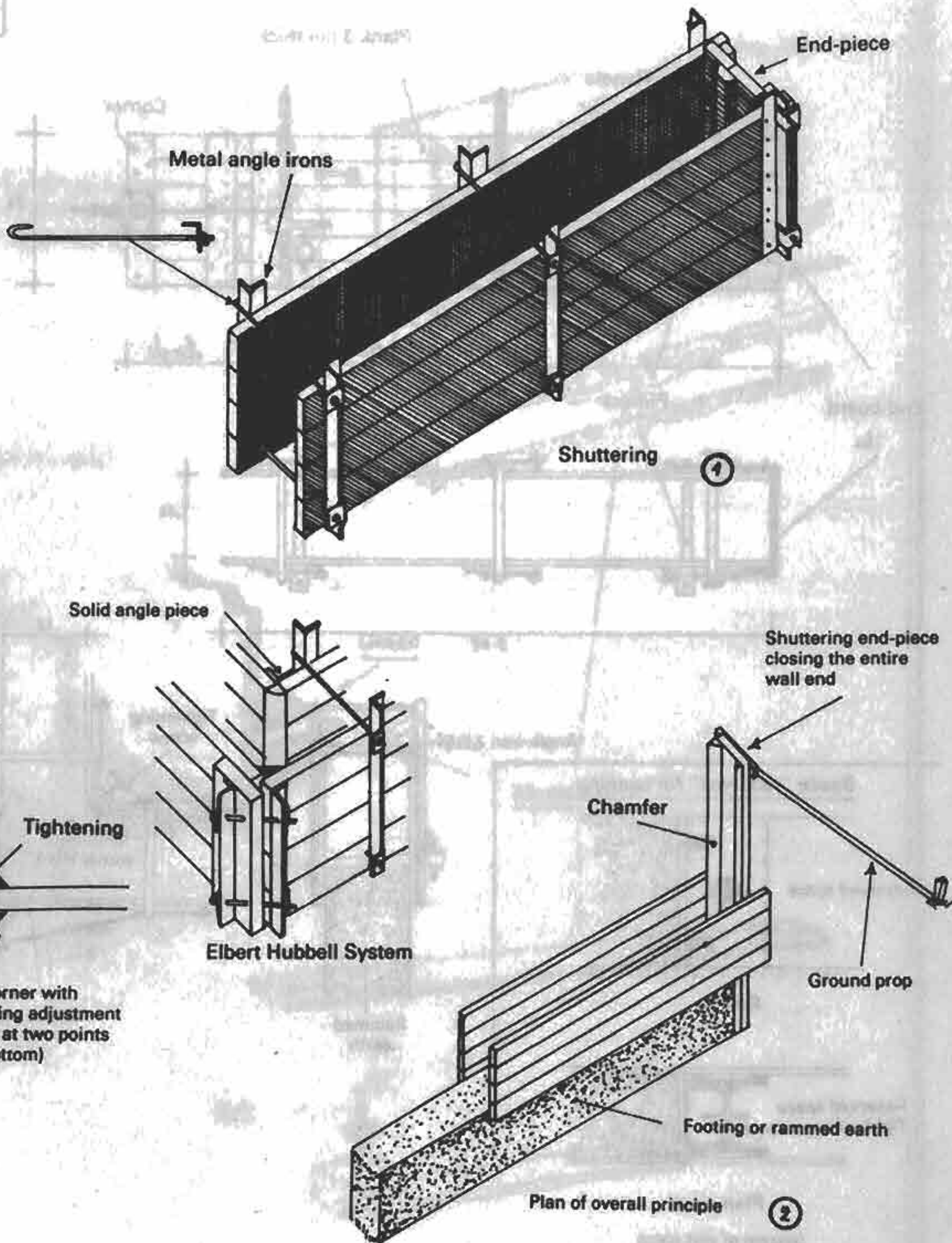

Shuttering corner with system allowing adjustment by tightening at two points (at top and bottom)

Elbert Hubbell System

Plan of overall principle

FIGURE 85

Type of Formwork : Formwork with plywood panels
Usage : Unlikely to have gone further than the planning stage ...
Document Reference : "Bâtir en Terre", Wolfskill.

H

1952

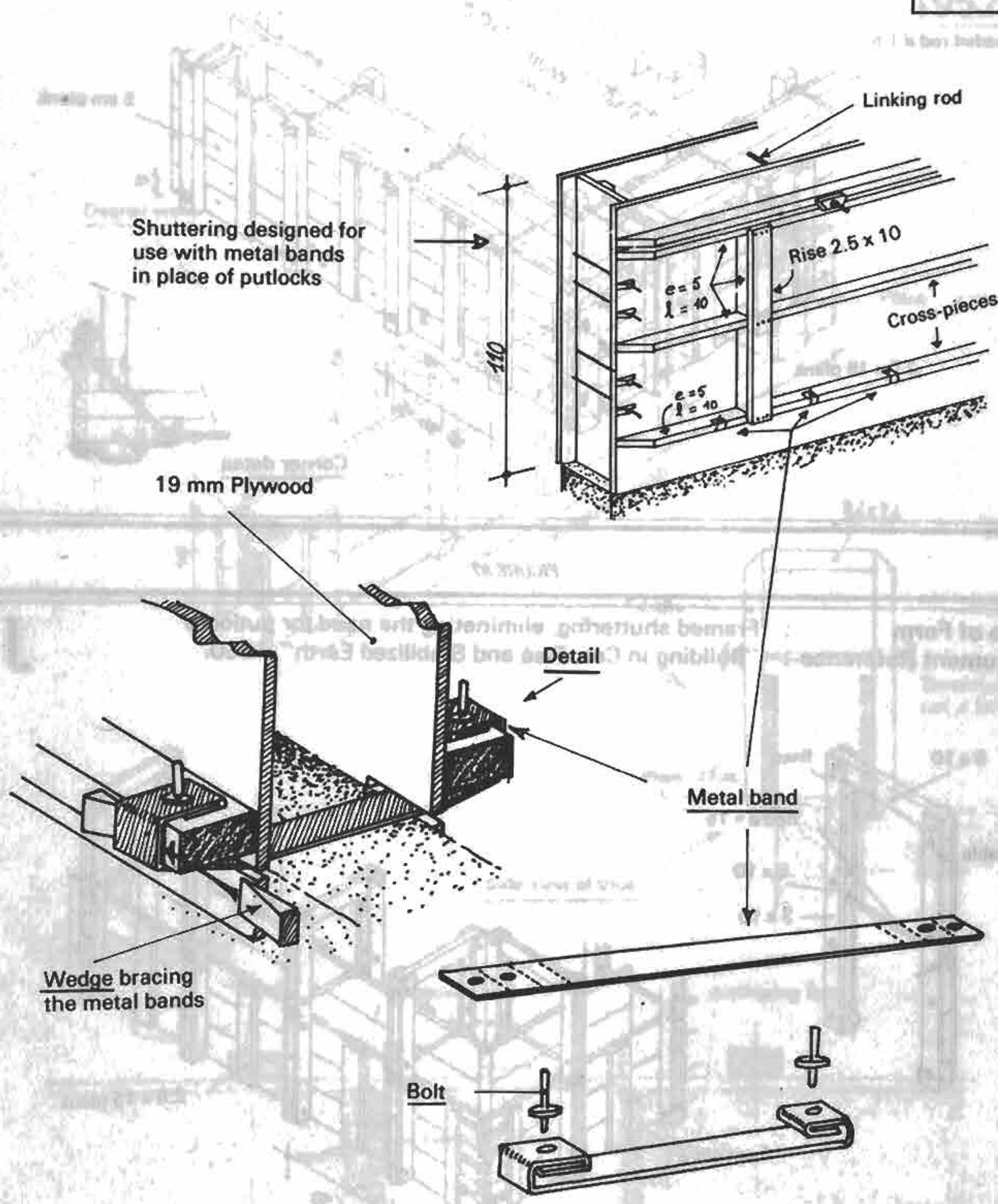

FIGURE 86

I

Type of Form : Formwork derived from traditional shuttering
Documentary Reference : "Building in Cob, Pisé and Stabilized Earth" 1950

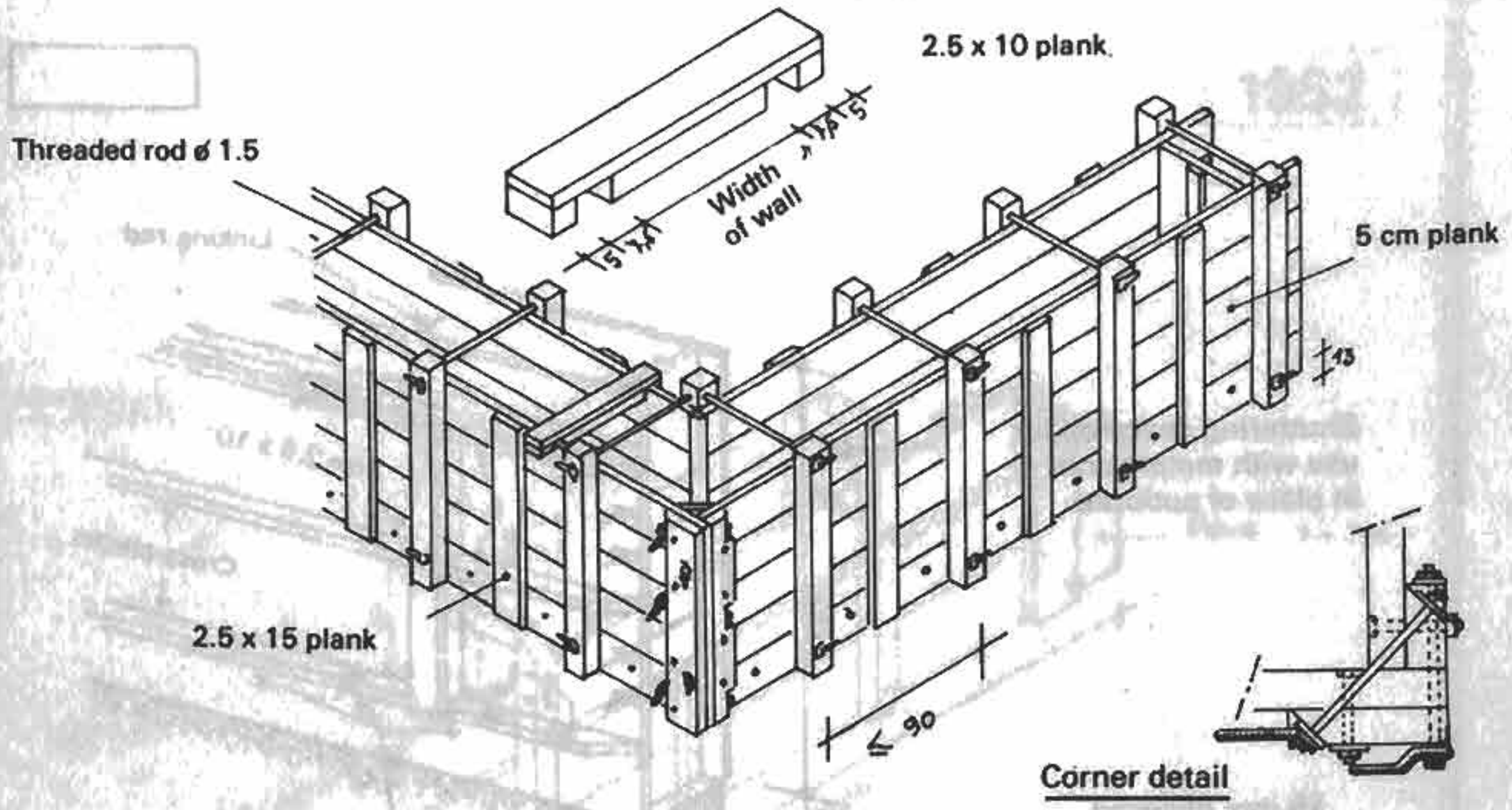

FIGURE 87

J

Type of Form : Framed shuttering, eliminating the need for putlocks
Document Reference : "Building in Cob, Pisé and Stabilized Earth", 1950.

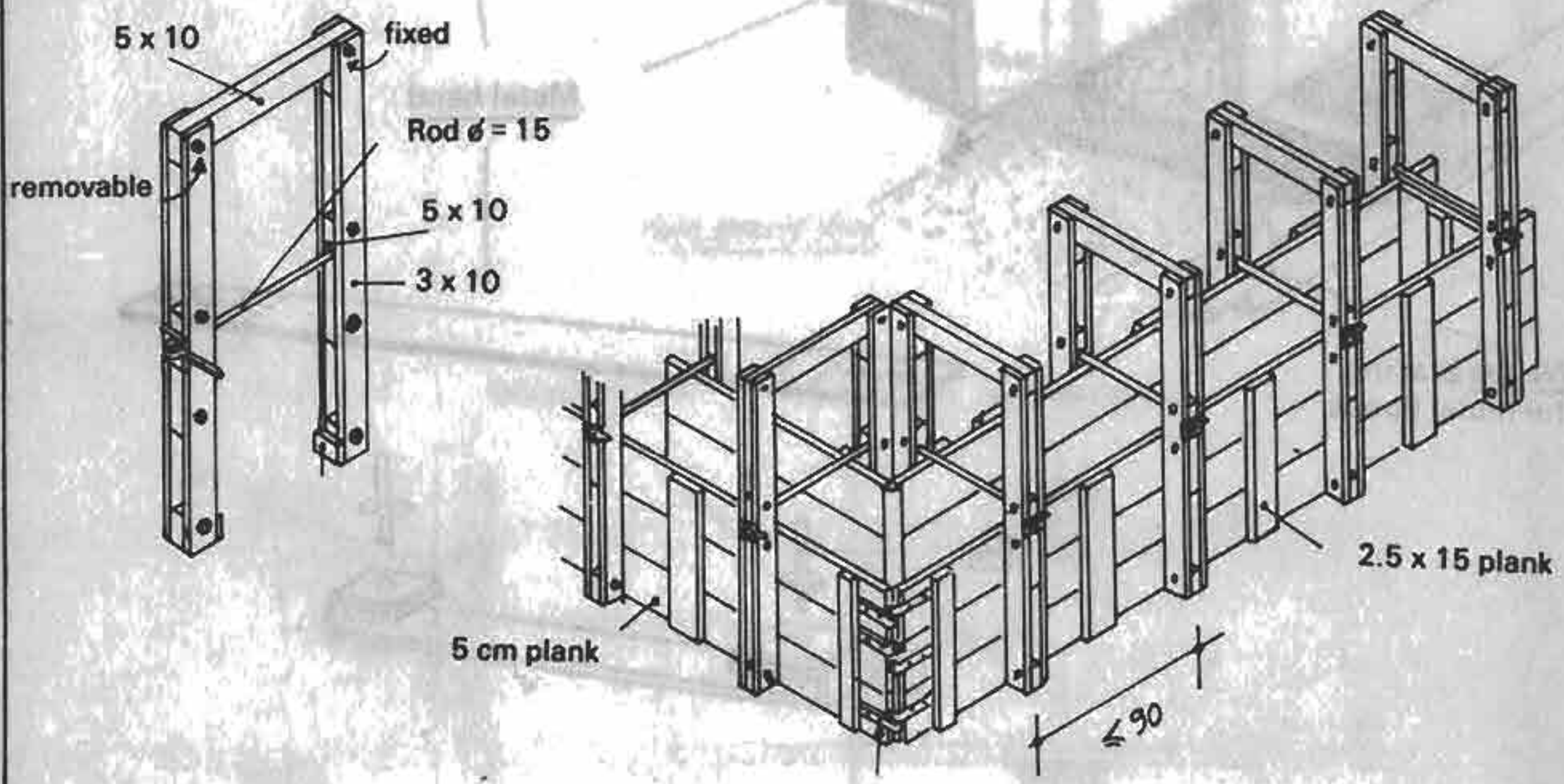
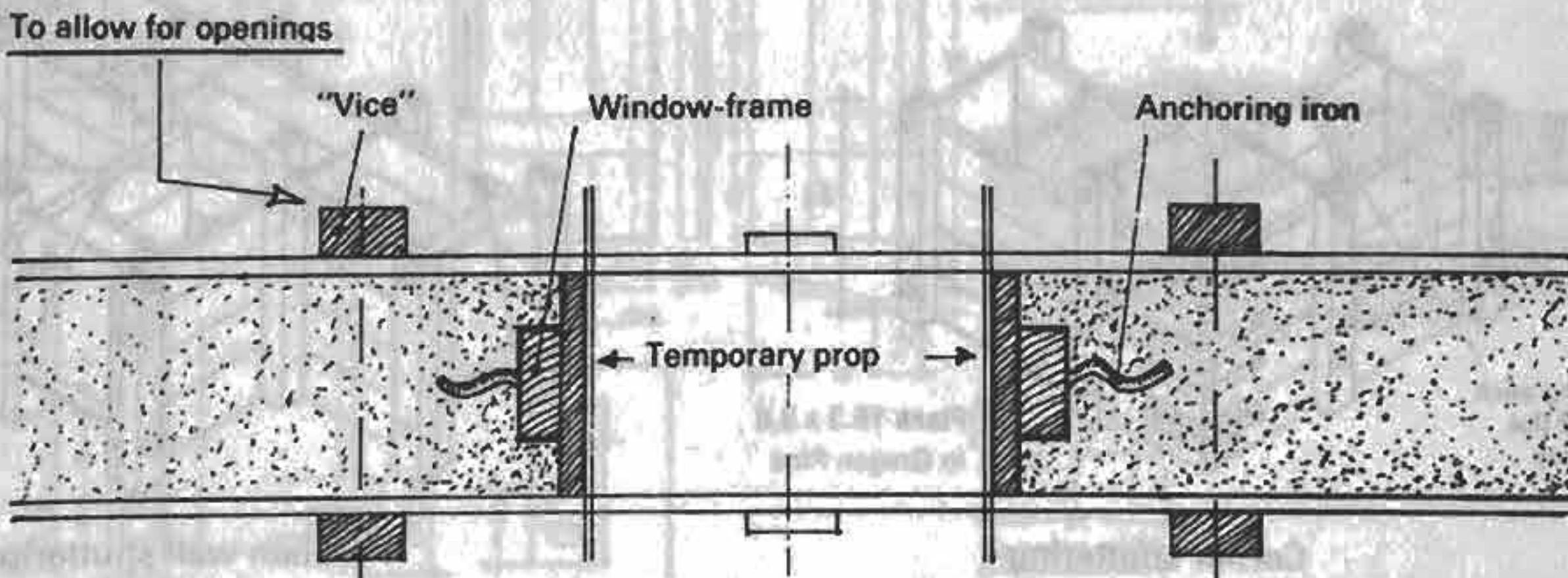
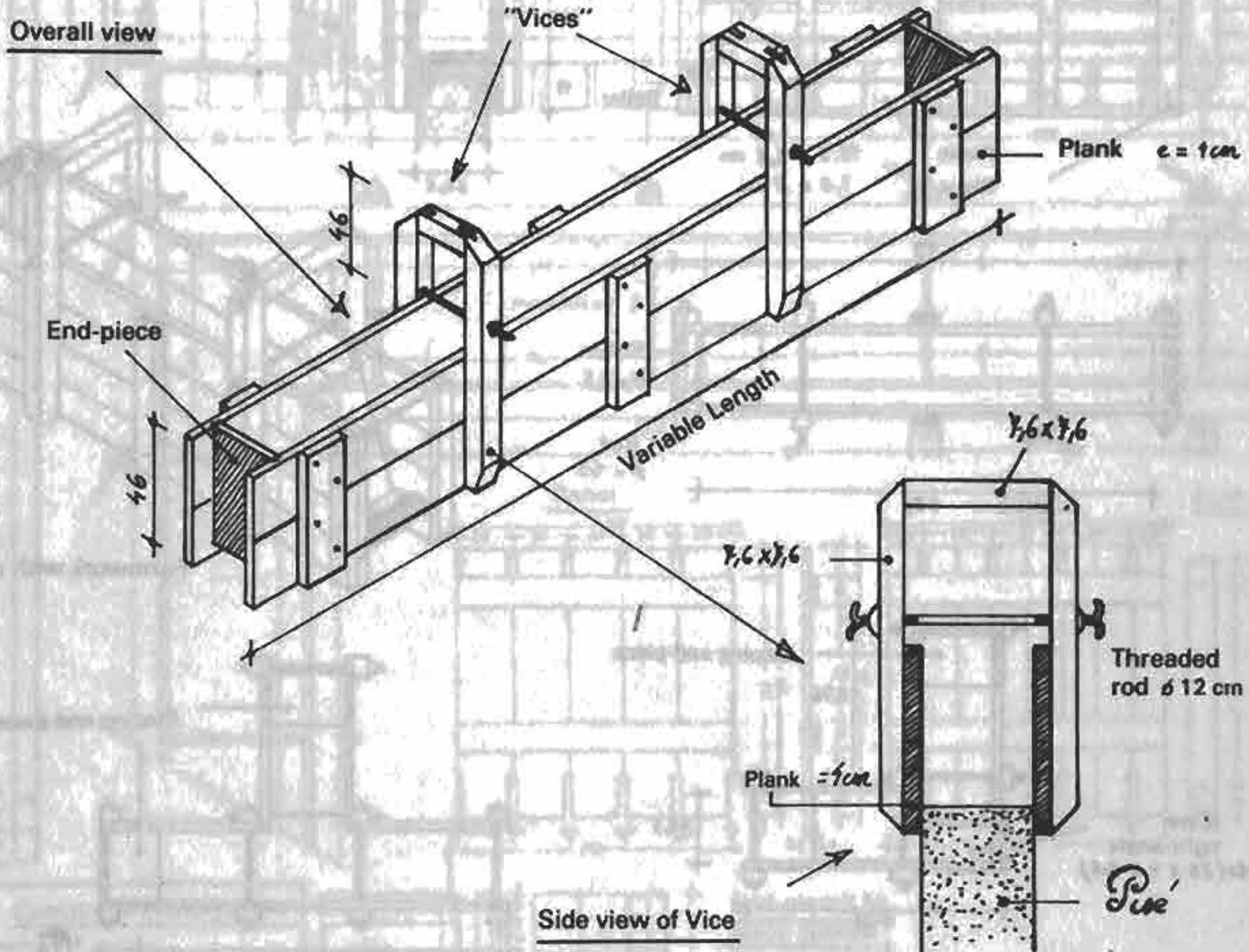

FIGURE 88

Type of Form : "Vice" formwork, (without putlocks)
Usage : Would appear to have gone no further than the design stage
Document Reference : "Earth Wall Construction" by G.F. Middleton (Commonwealth
Experimental Building Station - Australia)

K

1952



L

Type of Form : Formwork with rollers (without transverse ties) and corner and fixed partition formwork (with ties)

Usage : Used experimentally

Document Reference : "Earth-Wall Construction" by G.F. Middleton (Commonwealth Experimental Station - Australia).

1952

1952

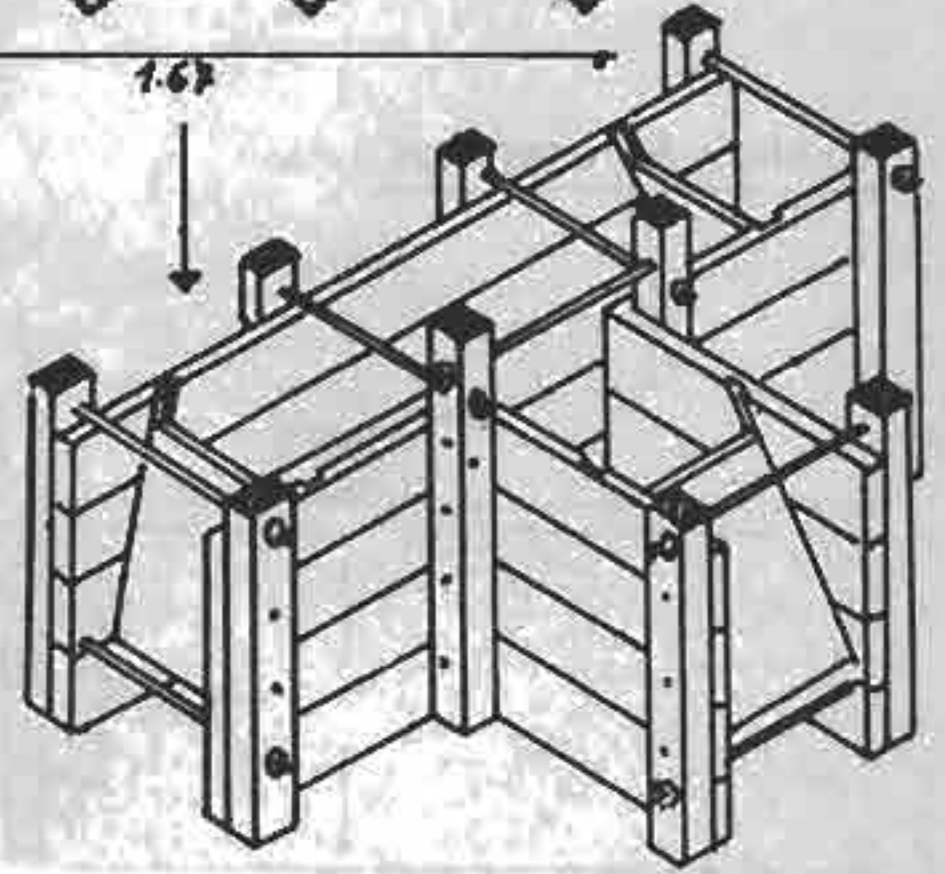
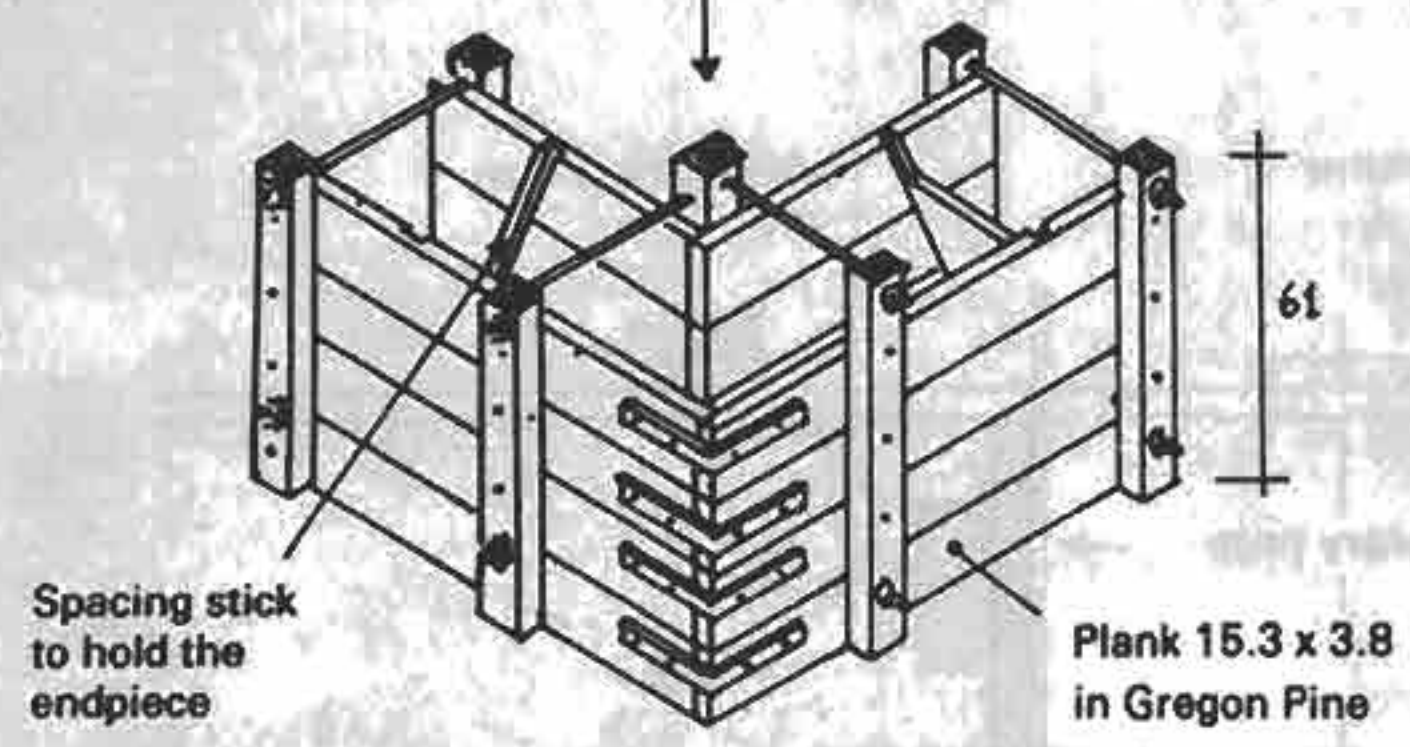
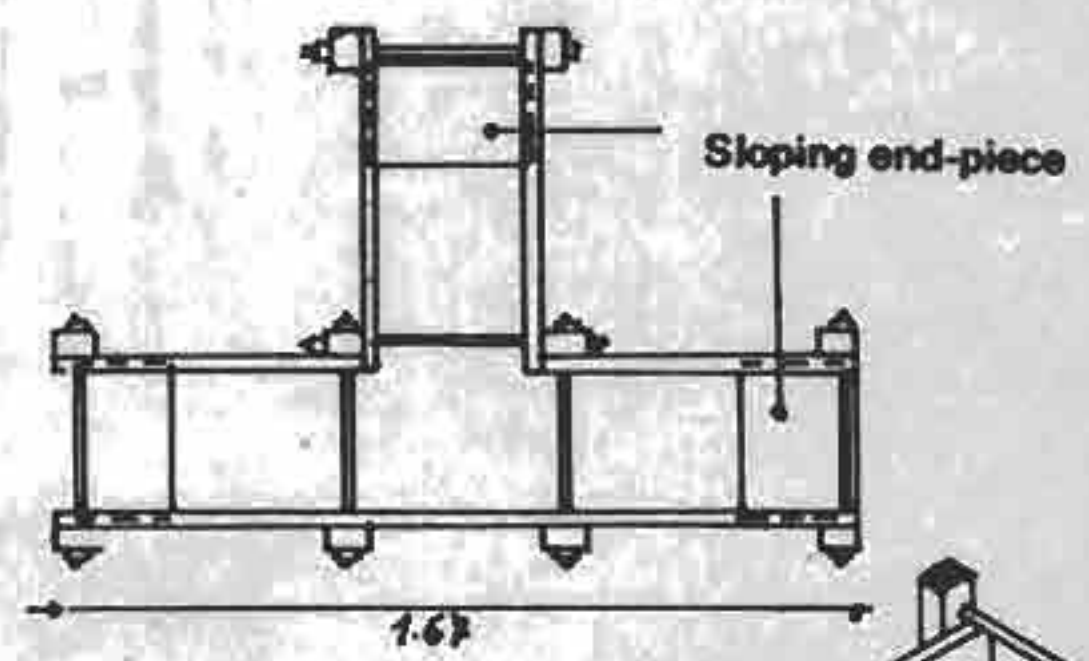
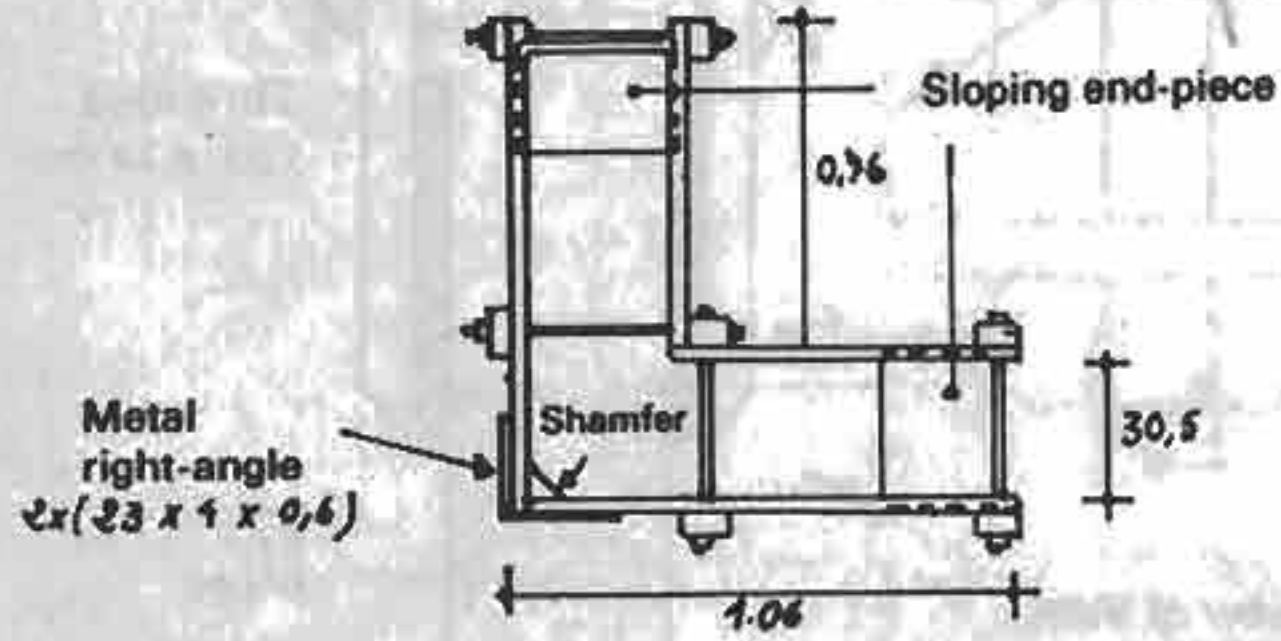
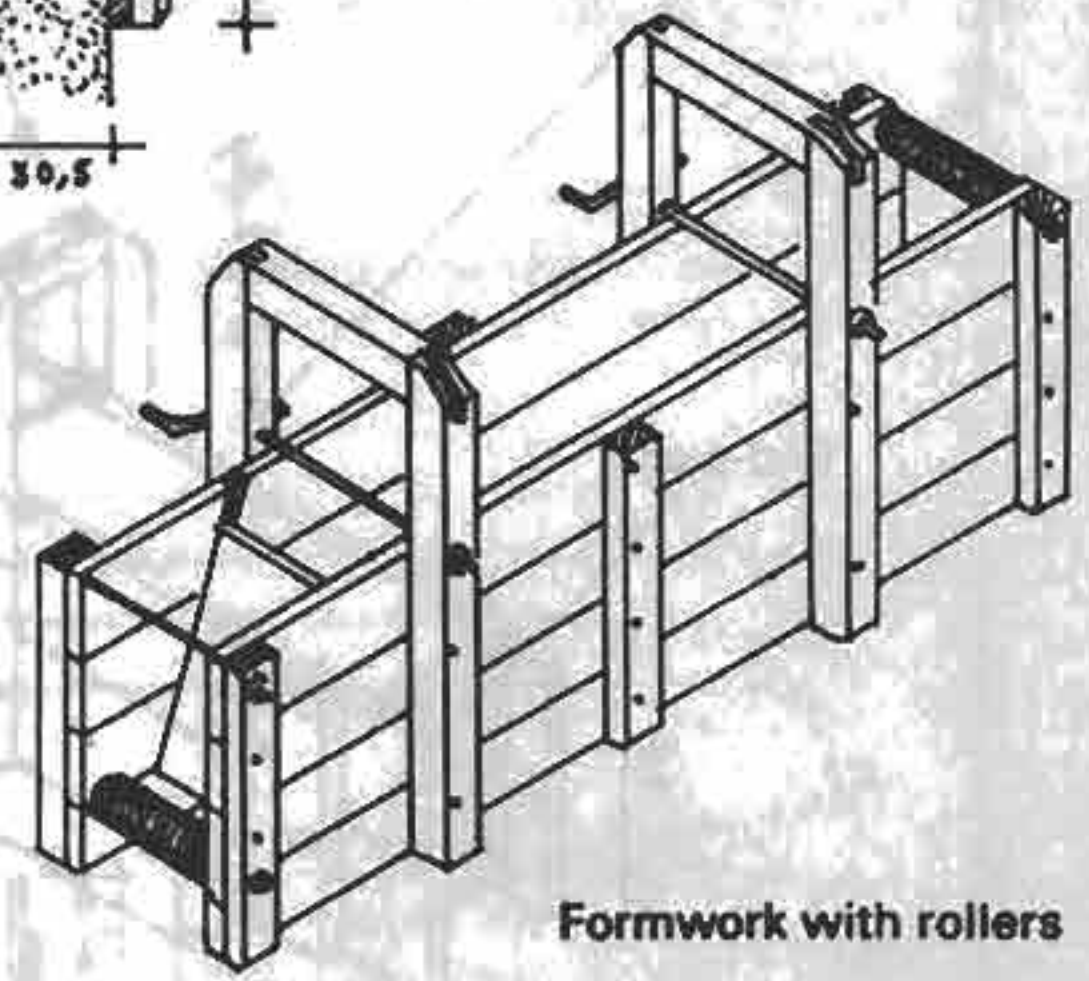
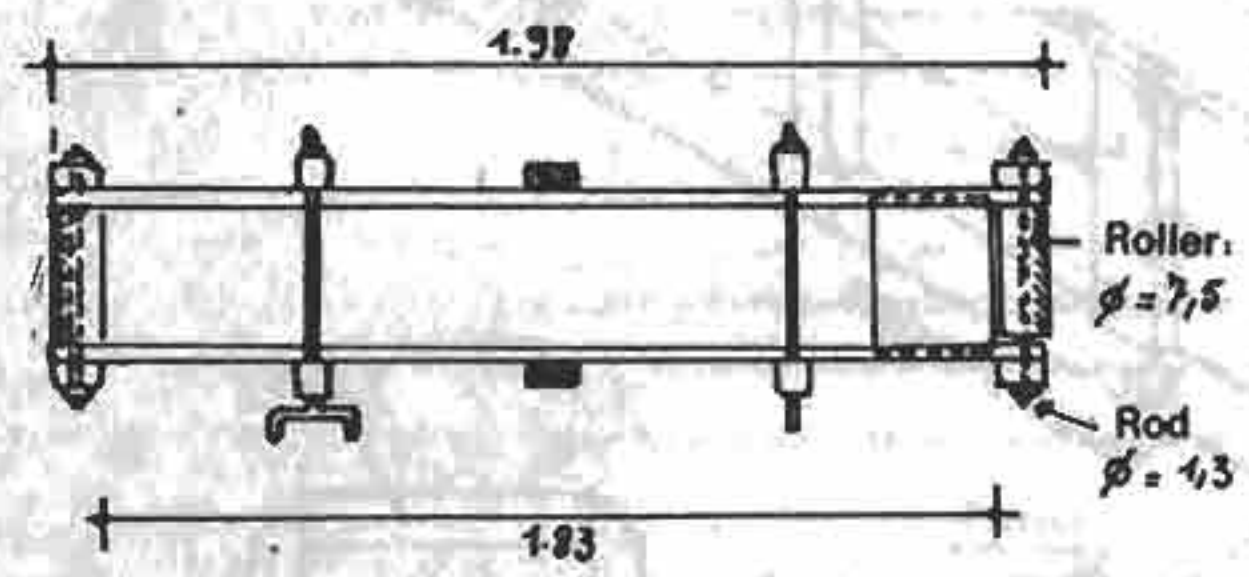
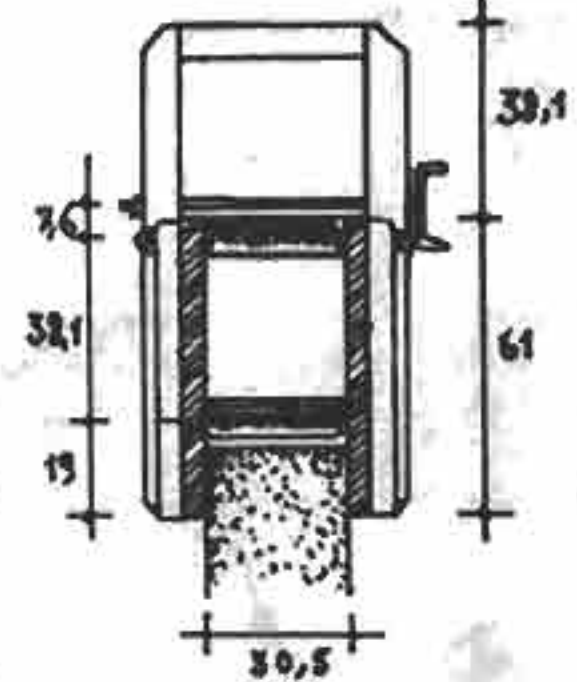
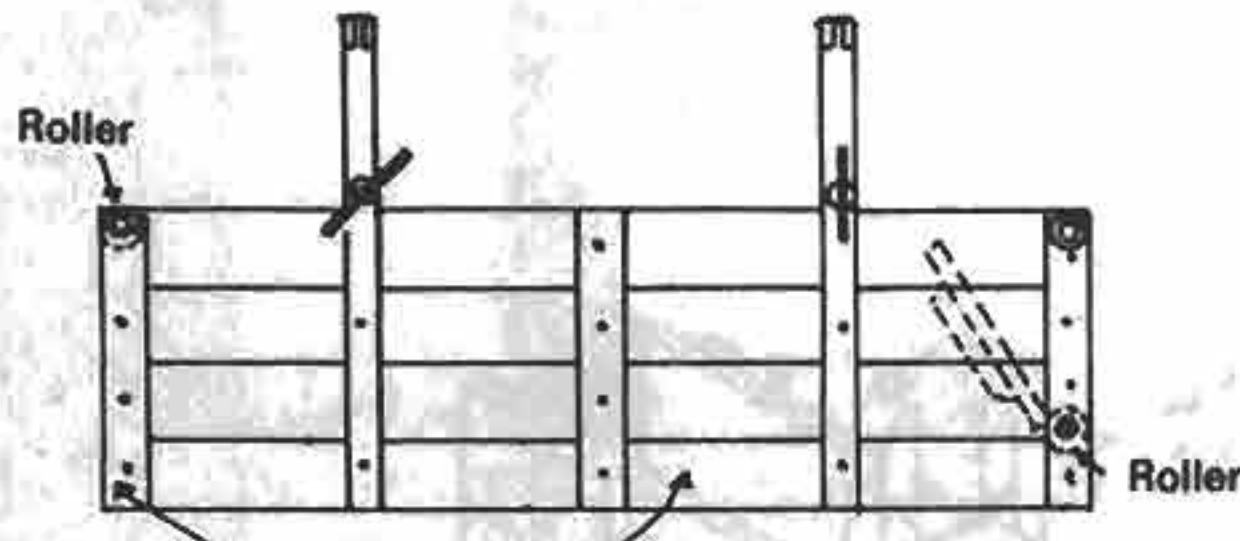

Corner shuttering

Partition wall shuttering

FIGURE 91

Type of Form : Integral horizontal formwork
 Usage : Used on site
 Document Reference : "Technik des Lehmbaues" by Pollack Richter (Germany)

M

1952

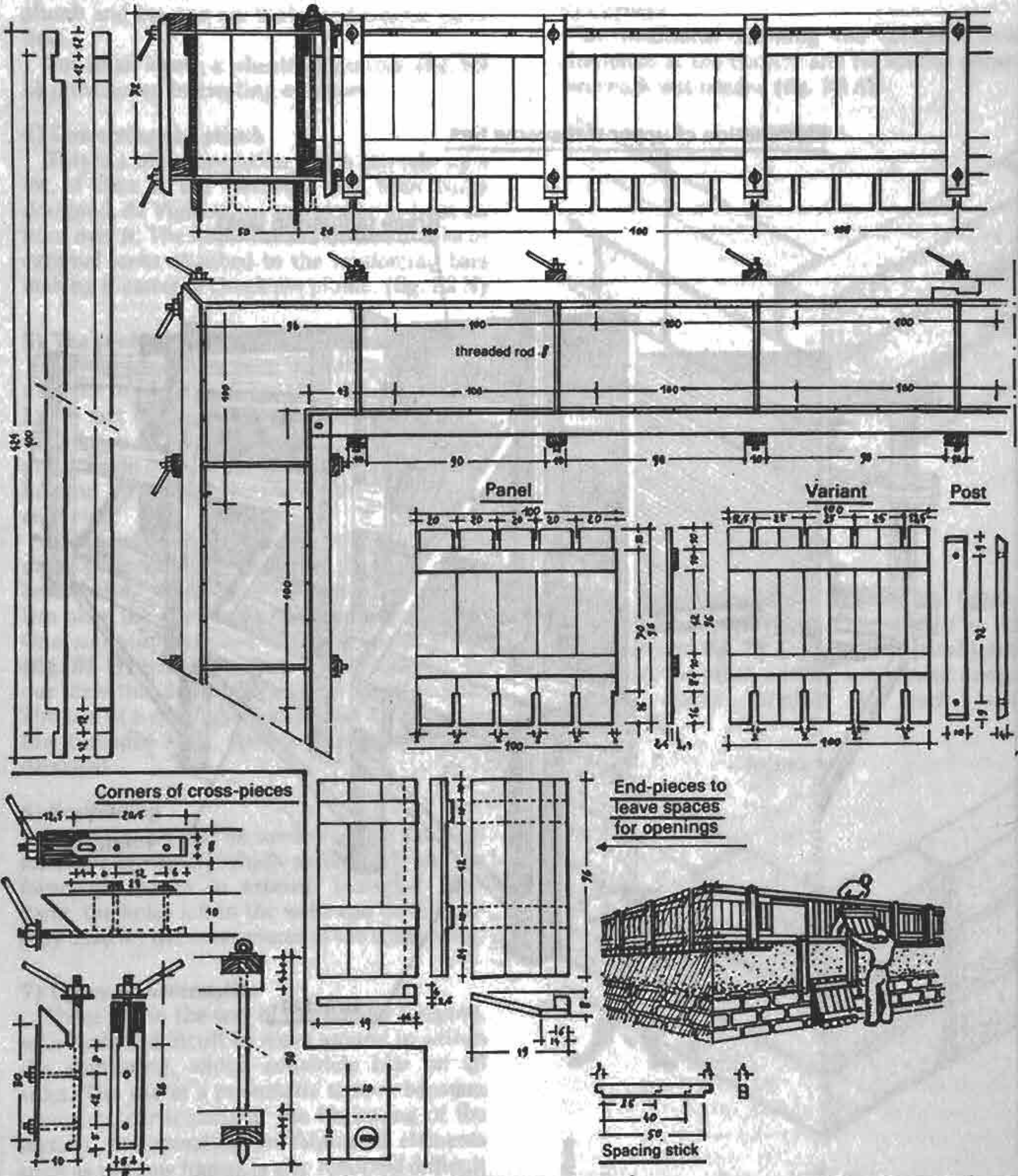

Type of form: Externally braced formwork

Usage : Designed by ADETEN, not tested

SECT

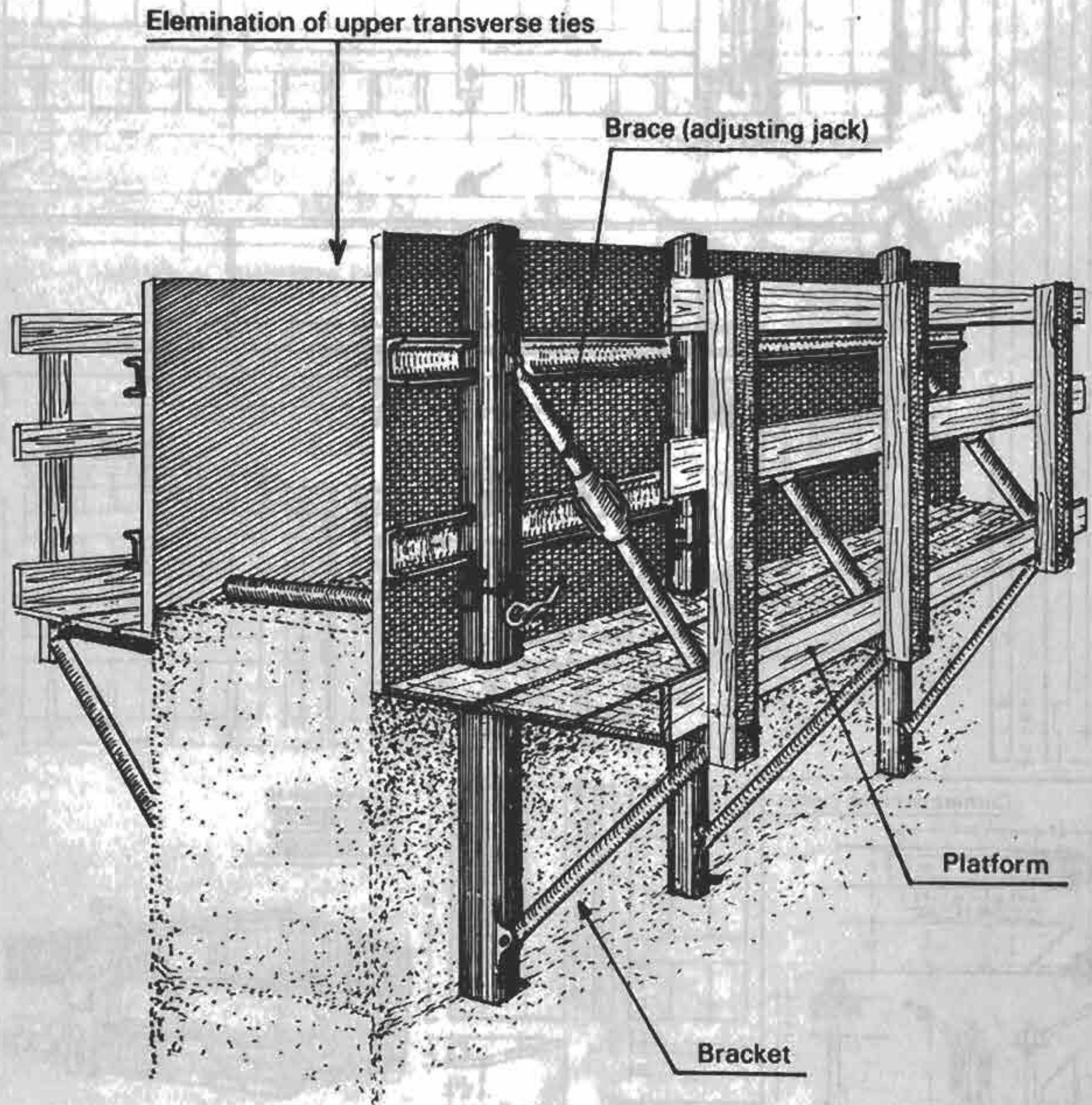

3) Manoeuvrability

The manoeuvrability of the formwork will depend on its weight. Elements designed to maintain its strength and rigidity will make it heavier. Thus any reinforcing integrated into the panels will mean using lifting equipment (crane etc.) We ensured the rigidity of our formwork at Vignieu thanks to omega-shaped removable metal clamps (fig. 102). Once the putlocks were in place setting it up took little time (20 min for a 4 m reach) but correcting the plumb and bracing are tricky and require more time.

For small forms, a wheeled formwork (fig. 89 L) provides an interesting solution.

4) Correcting the plumb

This is a tricky operation which can take up a lot of time if the formwork has been badly designed. At Vignieu we would take at least an hour over it. The formwork is adjusted thanks to external jacks attached to the reinforcing bars making it easier to check the plumb. (fig. 92 N)

5) The problem of putlocks or transverse ties

Various ideas have been put forward to eliminate the need for putlocks (figs. 87 J, 88 K, 89 L). In fact their only disadvantage is the holes they leave in the walls. On the other hand putlocks do help to fix the formwork in place, holding it together while the plumb is corrected.

If one takes the precaution of placing them on a little sand or wrapping them in paper beforehand, removing them presents no problem once the shuttering has been taken down. One solution proposed is to use metal strips (fig. 85 H) which are then left in the wall. In our view this seems difficult to apply on site. The use of a spacing stick (fig. 81 D) prevents the threaded rods used as ties from being damaged.

6) Scaffolding

Putlocks can also be used as part of the scaffolding (fig. 92 N) which serves to brace the formwork thanks to external triangles. Similarly, the holes left in the walls can be temporarily used for the cross-pieces of the scaffolding.

7) Upper transverse ties

These get in the way of the builder tamping, who finds it difficult to move around in within the shuttering, which constricts him on all sides. The use of a pneumatic tamper becomes unwieldy, particularly at the beginning of the section. Incorporating pre-fabricated elements such as window frames is also rendered difficult by these upper ties.

One formwork illustrated (fig. 82 E) uses a "screw press" system of ties which can be placed anywhere at will, but which have to be specially made.

The formwork we designed (fig. 92 N) was essentially intended to overcome the problem of eliminating the upper ties, allowing all the stress to be taken up by the external bracing. Its measurements have yet to be determined and trials carried out.

8) Corners

In traditional building the sections were alternated at the corners and no special corner formwork was needed (fig. 93 A).

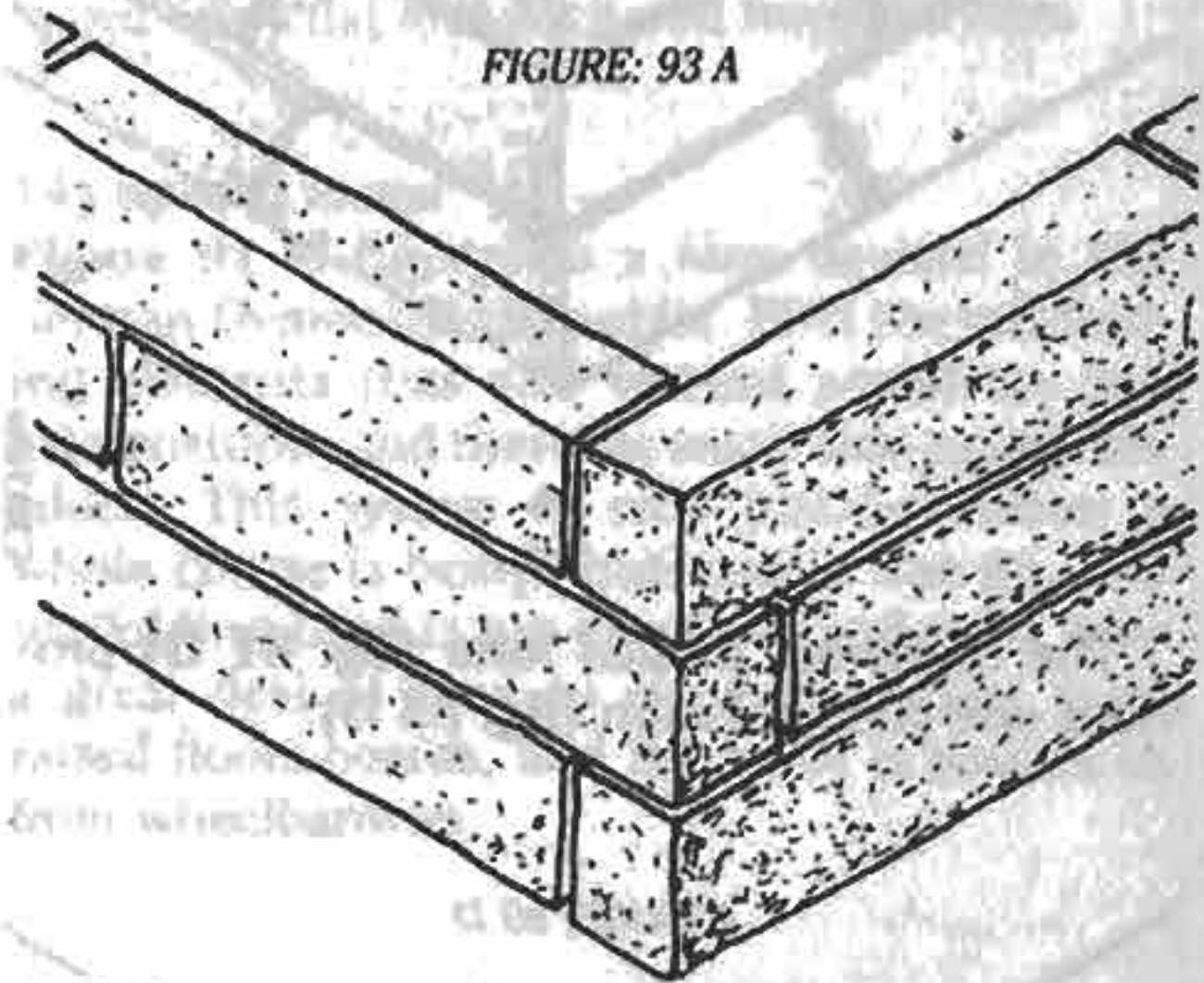

CRATerre

a

This system should not be dismissed lightly, particularly as a corner formwork such as the one shown in fig. 78 A results in vertical joints one above the other, and the subsequent danger vertical cracks forming, in both walls (fig. 93 B).

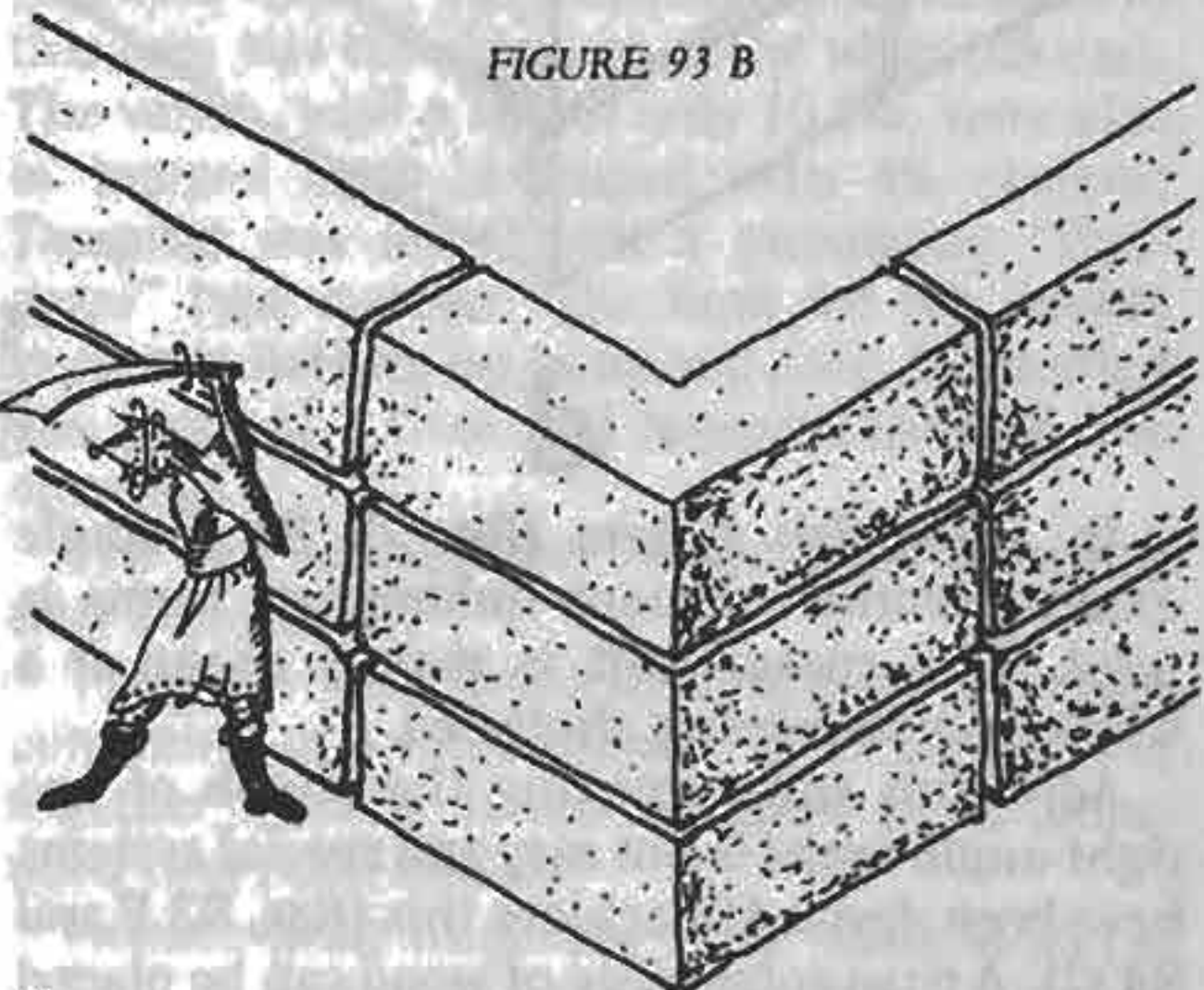

CRATerre

b

One solution (fig. 93 C) involves "slanting" the joints; this is the principle used in the corner and split forms illustrated in fig. 89 L. This method presents no obvious advantage over the previous one.

FIGURE: 93 C

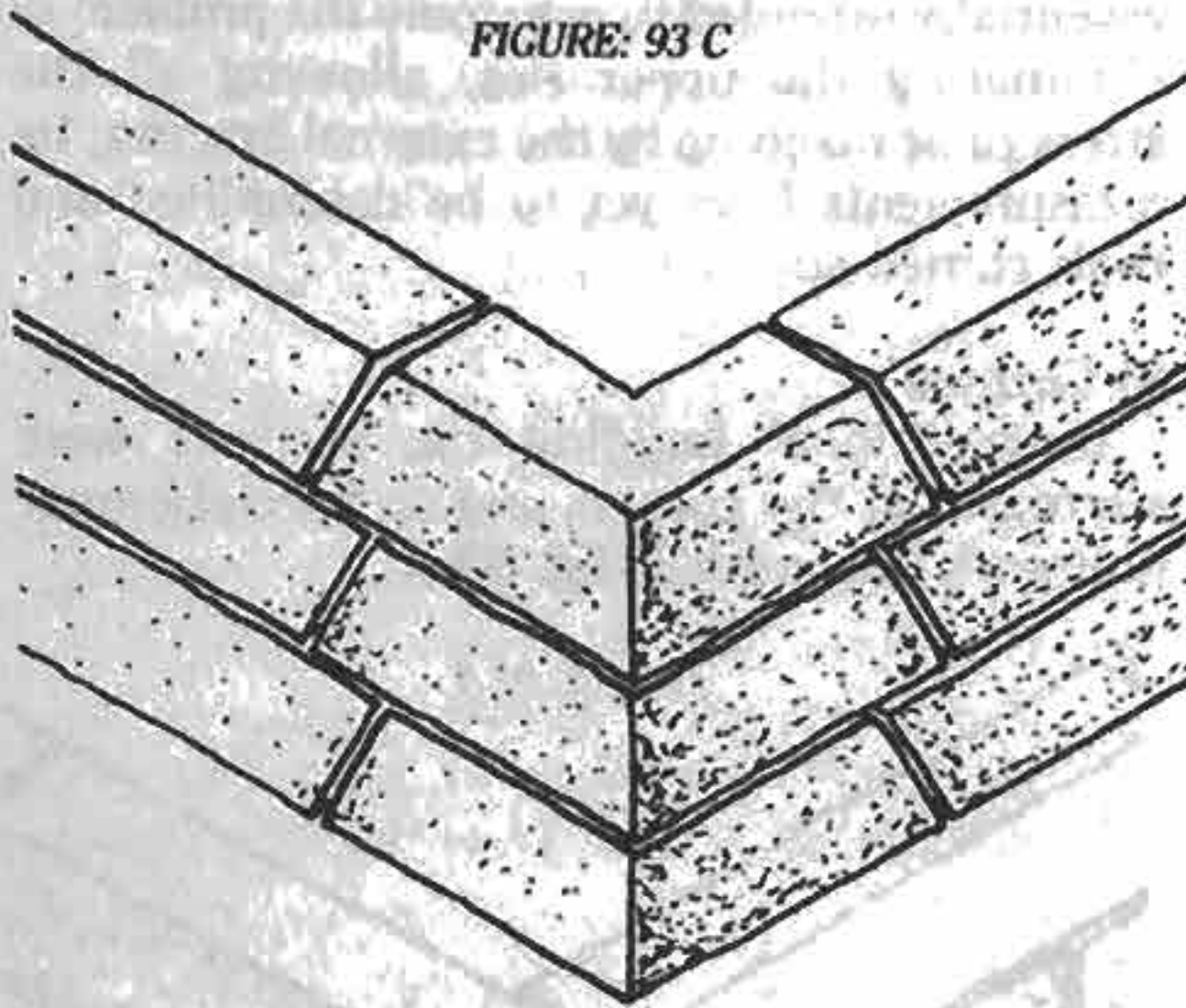

C

CRATerre

The reversible hinged form (fig. 81 D) provides one good solution (fig. 93 D).

FIGURE: 93 D

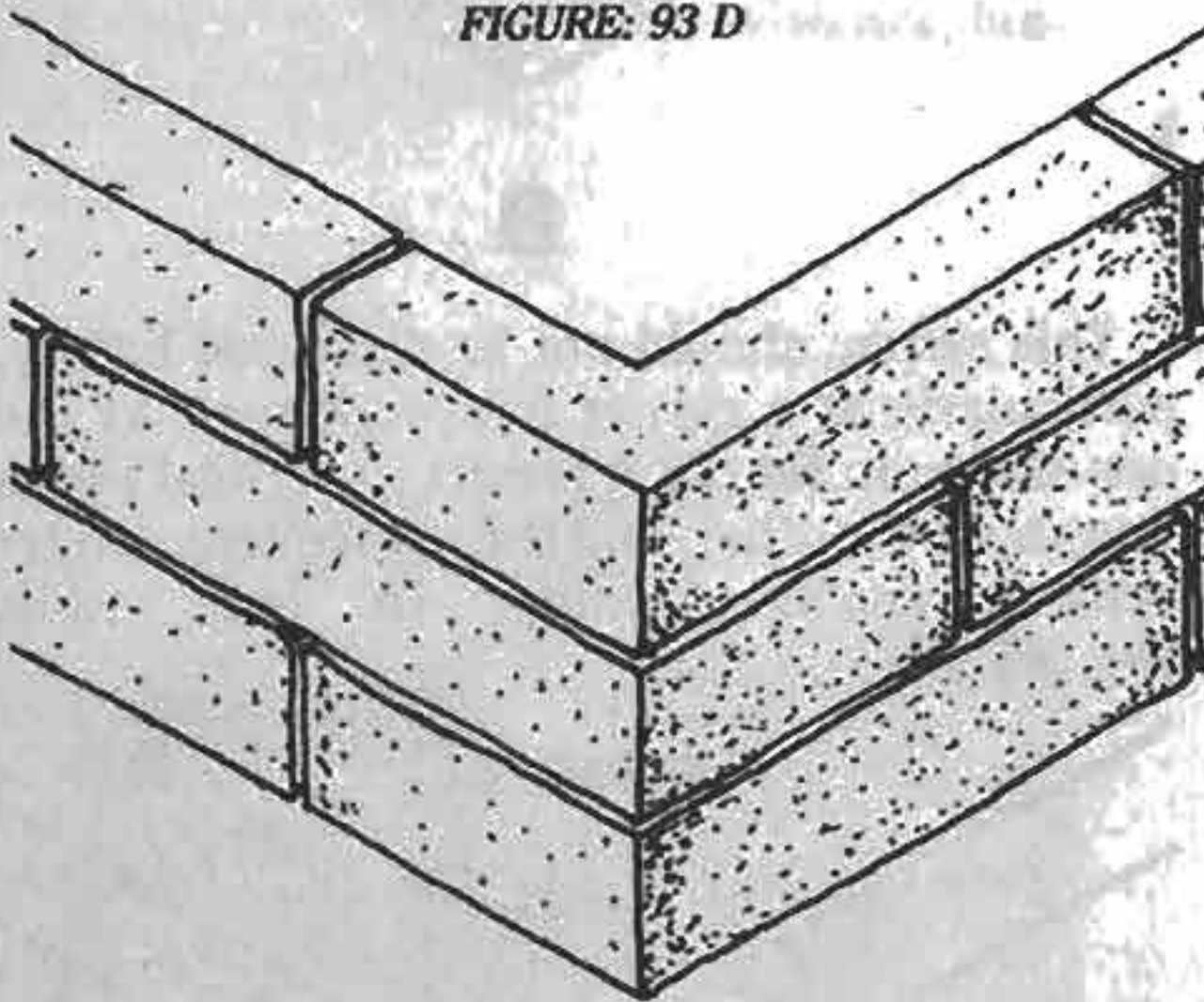

d

CRATerre

In a Swedish system (fig. 79 B) a single external corner element linking two forms is used. This corner unit is mainly useful if a whole course is being shuttered.

Adjusting and correcting the plumb of two right-angle forms is not easy and special systems have been devised to achieve this (figs. 83 F and 84 G). A triangular piece of wood can be placed in the angle to chamfer the corner. The hypotenuse can be replaced by a concave curve 5 cm

deep which gives a neat rounded corner less vulnerable to erosion. The same can be done for the edges of openings.

As corners remain a somewhat thorny problem, one approach has been to create an architectural design where the building consists only of segments which are held together by the foundations and the ring-beam, the latter also serving as a lintel for the openings (fig. 94).

To avoid having to set up an end-board too frequently, one option is to build wall segments

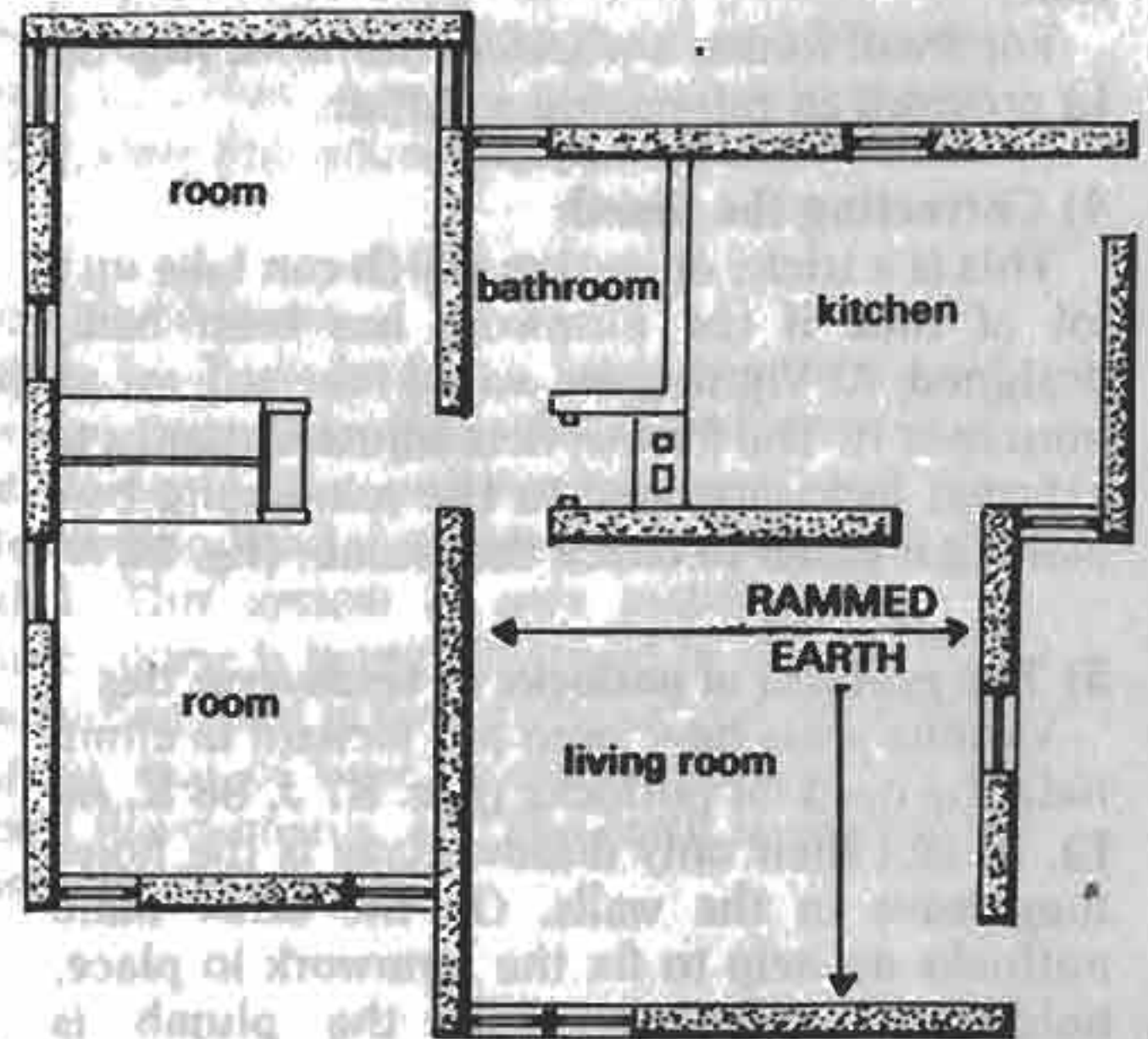

FIGURE: 94
EXAMPLE OF ARCHITECTURAL
DESIGN WHICH ELIMINATES
RAMMED EARTH CORNERS (HIBBEN)

Hibben

(fig. 84 G2) in which case a plank shuttering the width and the whole height of the wall is braced against it: the bracing has to be extremely strong.

9) Flexibility

Usually the length of forms cannot be varied. The one shown in fig. 81 D enables one to use a small or a large panel singly or continuing on from one another. In practice one often has to vary the normal length, to allow for unplanned openings or walls. In these cases it is common to use one or two end-boards. One has to be able to fix these easily and firmly in place. Nailing end-boards to the form is not recommended as this damages them and entails a good deal of wasted time. This was to prove a constant problem on our own site. Figure 83 F shows one possible system for an end-board which holds simply by pressure on the side-panels. But there is always the risk of its sliding because of the pressure exerted on it.

10) Incorporating prefabricated elements

The upper transverse ties and lower putlocks all get in the way of incorporating frames for openings, alcoves, cupboards etc. Mobile formwork ties overcome this problem (fig. 82 E). These prefabricated elements must be strongly built and well-braced from the inside. We attempted to use a ferro-cement structure which in the event proved quite long to build and very heavy to handle. Inadequate bracing was probably the cause of its poor resistance to pressure from the earth, which resulted in its losing its shape to a significant extent. We also used vault forms. To be able to remove them we had to place them on sand or on wedges; one must bear in mind that rammed earth shrinks (by approximately 0.7%).

11) Distance between the formwork panels

Moving around within the form should be easy, and the minimum distance between side-panels should therefore be between 35 and 40 cm. Thickness can vary according to their function. Threaded rods provide one easy way to regulate width. For speed and convenience, butterfly bolts are preferable.

FIGURE: 90
AUSTRALIAN FORMWORK
WITH ROLLERS

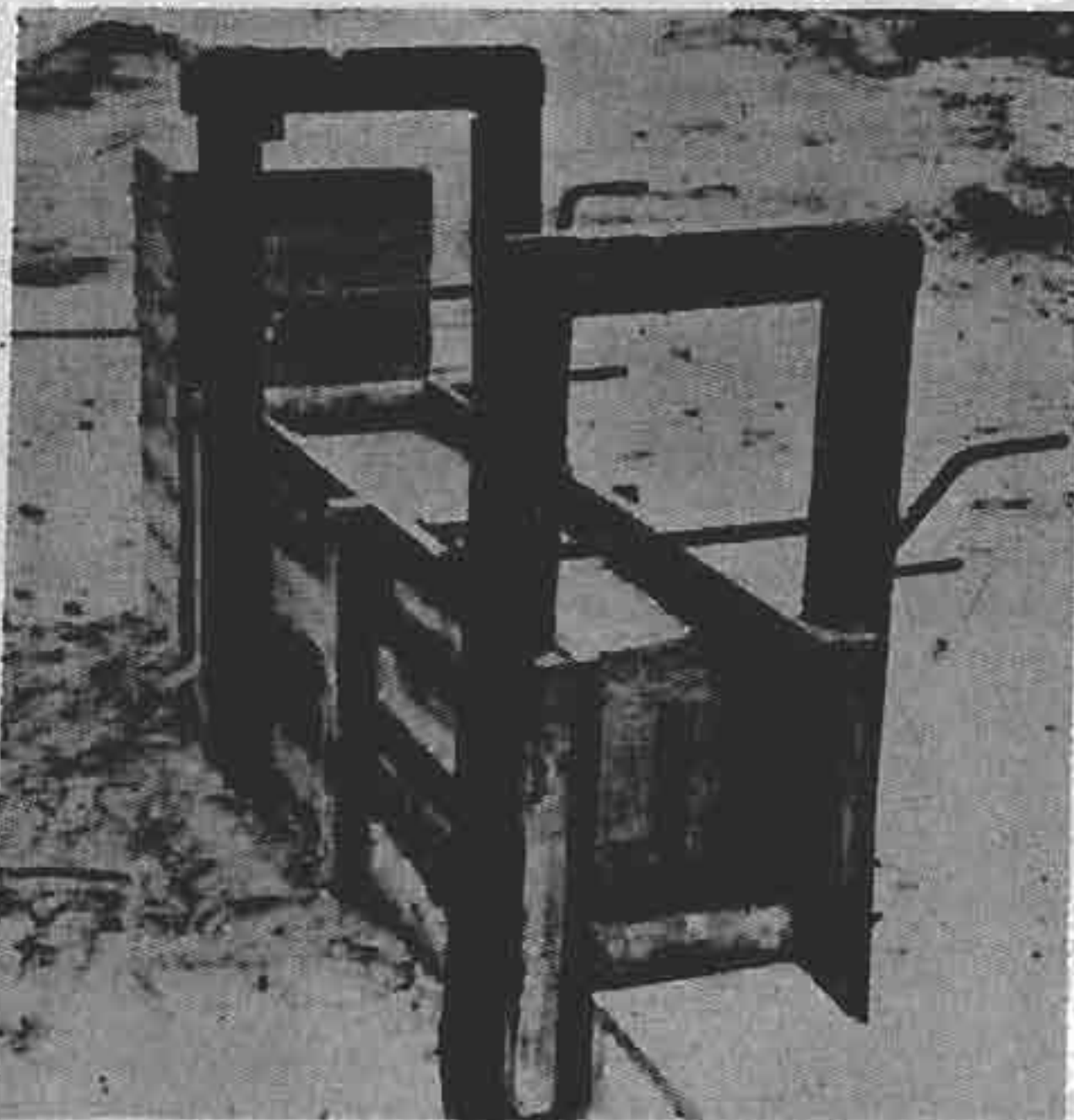

Middleton

12) Lining

Depending on how smooth or rough a finish is required (for example to enable a render to adhere better), the panels will be planed to varying degrees of smoothness.

13) Maintenance

To protect them from mildew and to make removing the shuttering easier, the inside of the form is greased. Used engine oil is adequate, spread in a thin layer. The form should always be put away flat and sheltered from the rain.

14) Special forms

Figure 91 M illustrates a form devised in the German Democratic Republic. First the reinforcing elements (ties and vertical posts) are put into position, and then the small side-panels are added. This system is only justified when a whole course is being shuttered in one go. The scaffolding used is too extensive and must take a great deal of time to erect; the effect is of raised floors-boards, and the earth is poured in from wheelbarrows.

15) Shuttering of the entire building

In one experiment led by the C.E.R.F. in 1967 in Ouarzazatte, Morocco (fig. 95), the aim was to construct minimal cost rural housing in Stabilized Soil Concrete. The entire building was shuttered. The metal form made up of elements which would be manipulated by hand and assembled as required. This method was used not only for the walls but also for the roofs (low-rise vaults). The important particularity in this case was the thinness of the walls (25 cm). The vaults, with a rise of only 10 cm, were also in tamped earth stabilized with 4% cement. Tamping was done with a pneumatic "Podgorni" type rammer. The form for the double vault was held up on jacks and then dismantled one piece at a time and removed through the openings.

The two houses were "unmoulded" one day after being built.

The form was obviously expensive to make, consisting in a large number of elements held together by rods. It was designed to be amortized over 3000 houses.

Reducing the thickness of the walls to 20 cm strikes us as a poor economy, particularly in a country where the thermal insulation of the building is an important consideration.

Ouarzazate Project

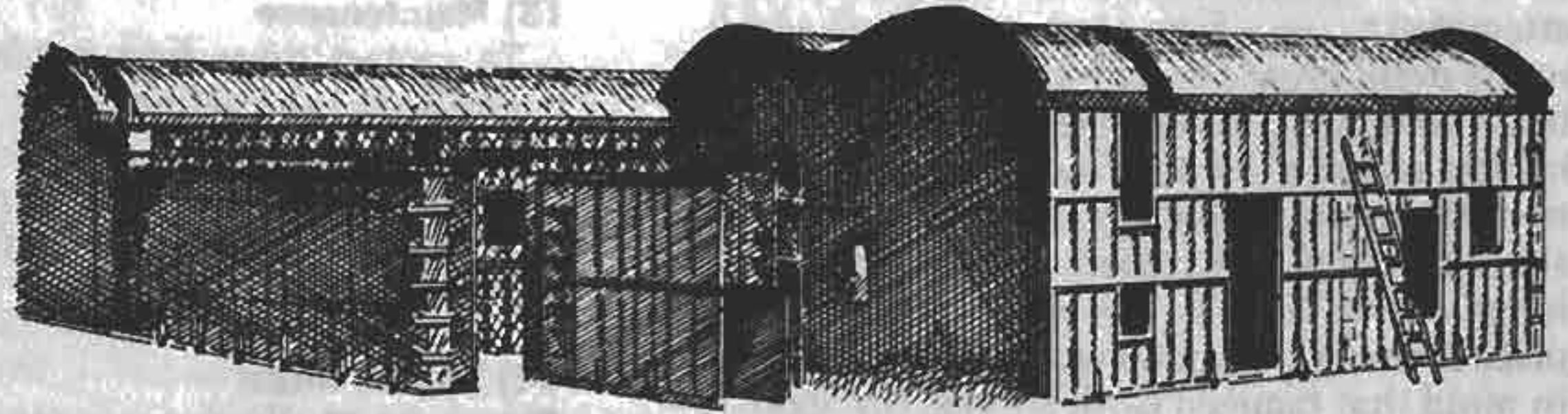

Shuttering

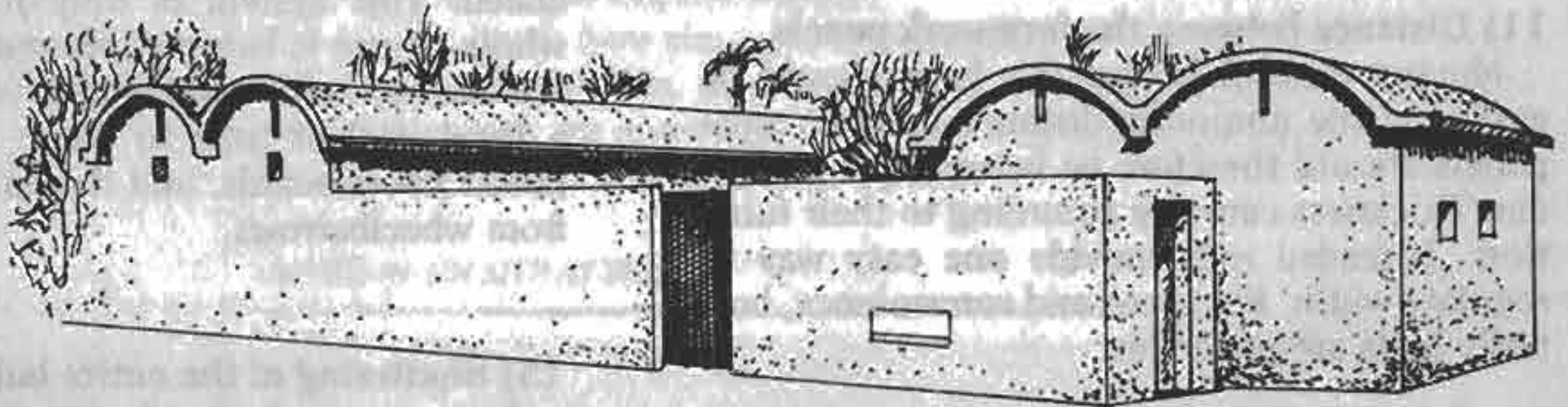

general view of buildings

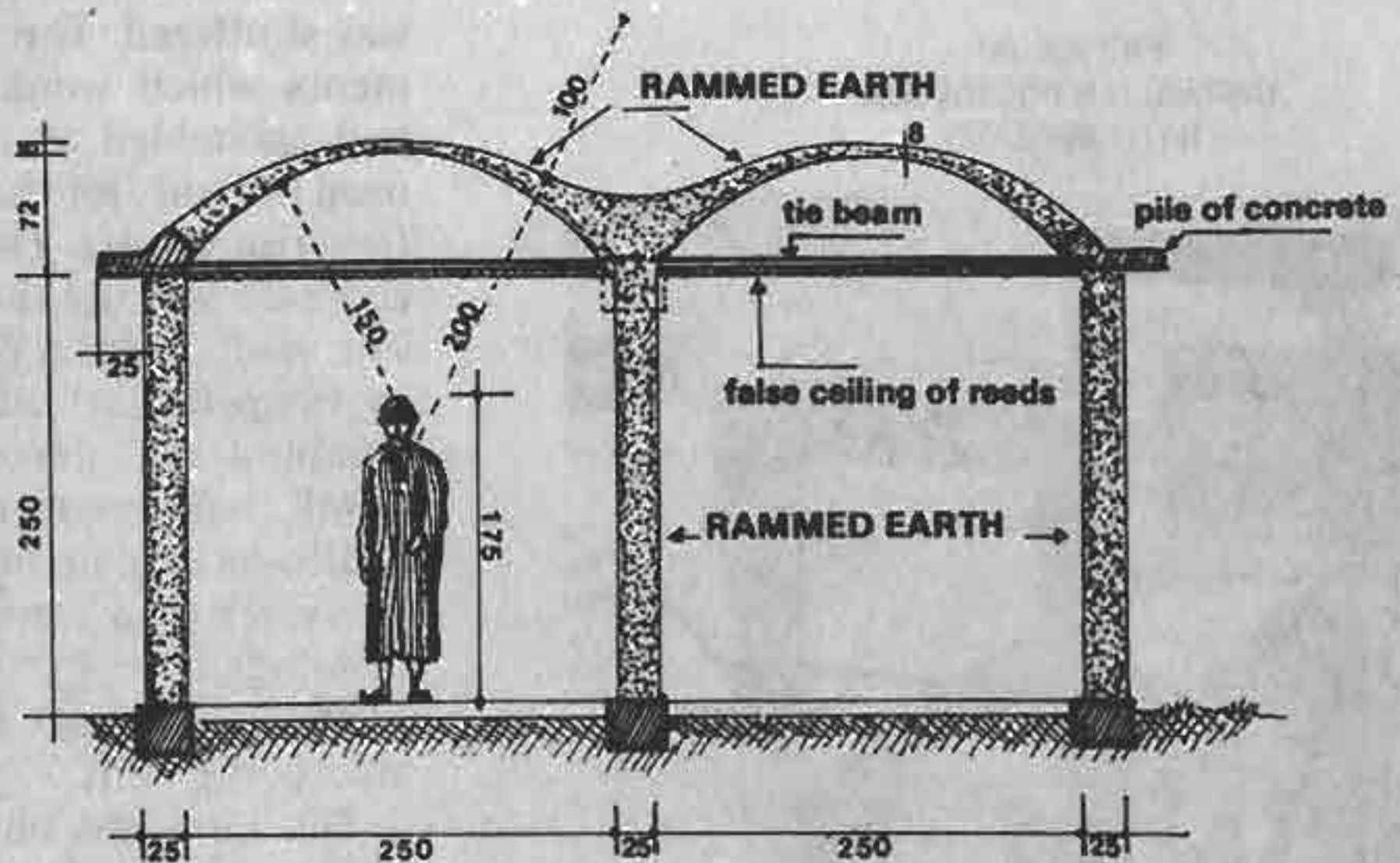

Section

Vignieu: the construction of an experimental rammed earth house in the Isère region (France)

In 1976 ADETEN was mandated by the Ministry of Equipment to carry out a feasibility study on the use of rammed earth. It was at that time our opinion that thanks to improvements and innovations in the application of rammed earth building it could be made economic, given that it possessed a number of advantages both on a technical level and as regards the comfort of the inhabitants and economical use of materials.

It was decided to conduct an experiment in the course of which, in the summer of 1976, a small experimental building was erected in the village of Vignieu. This enabled us to test the formwork we have already described as well as various compacting machines. Our objective was not to put up a demonstration building from an architectural point of view but rather to study the various problems relating to the technique.

The earth was excavated near the site and sifted through 4 cm diameter sieves. Having been transported by wheelbarrow it was either used as such or if necessary slightly moistened (it was a very dry summer...) The earth was carried up and poured into the formwork in buckets and compacted with a Ram 30 (Atlas Copco) rammer.

The results of this experiment are not given here since our conclusions are incorporated into the relevant chapters (particle size distribution, the Proctor test, formwork, compaction, etc.) Photographs illustrating site work are given here, together with a table summarizing and comparing the time taken for various activities (fig. 107).

FIGURE 98: ON SITE AT VIGNIEU



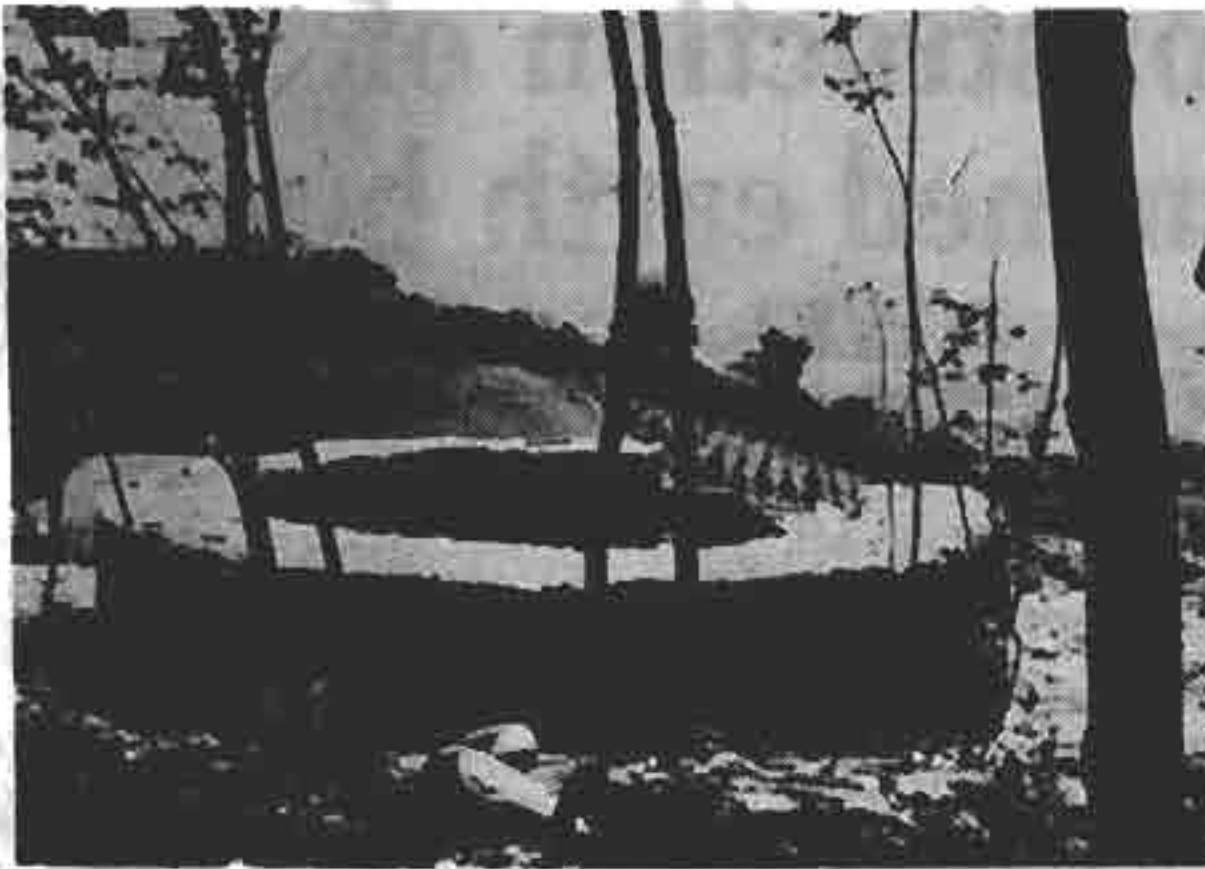

CRA Terre



CRA Terre

▲ **FIGURE: 96 EXPERIENCE AT LE PIN (ISERE, 1975) OF THE "PALAFITTE" TEAM, PART OF THE SCHOOL OF ARCHITECTURE OF GRENOBLE - CIRCULAR RAMMED EARTH BUILDING.**

FIGURE: 97 HINGED FORMWORK ALLOWING FOR CURVED WALLS AND POSTS - HORIZONTAL POSITION (LE PIN, 1975)

FIGURE: 99 FILLING THE FORMWORK AND COMPACTION

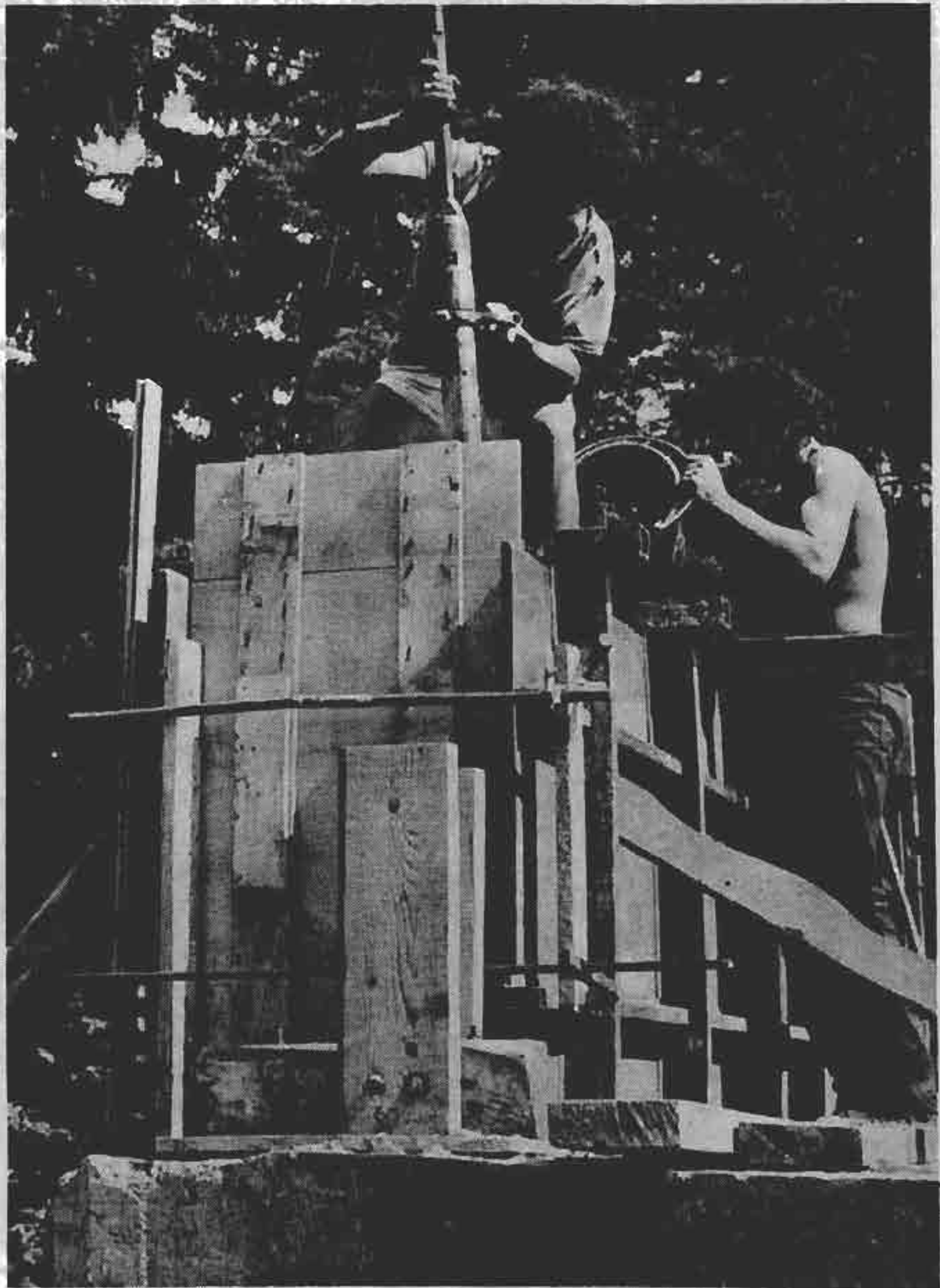

ADETEN

FIGURE 100:

Tools used at Vignieu

1. American shovel
2. Pick-axe
3. 30 mm mesh sieve
4. 80 l wheelbarrow
5. Rake for mixing and removing stones
6. Watering-can

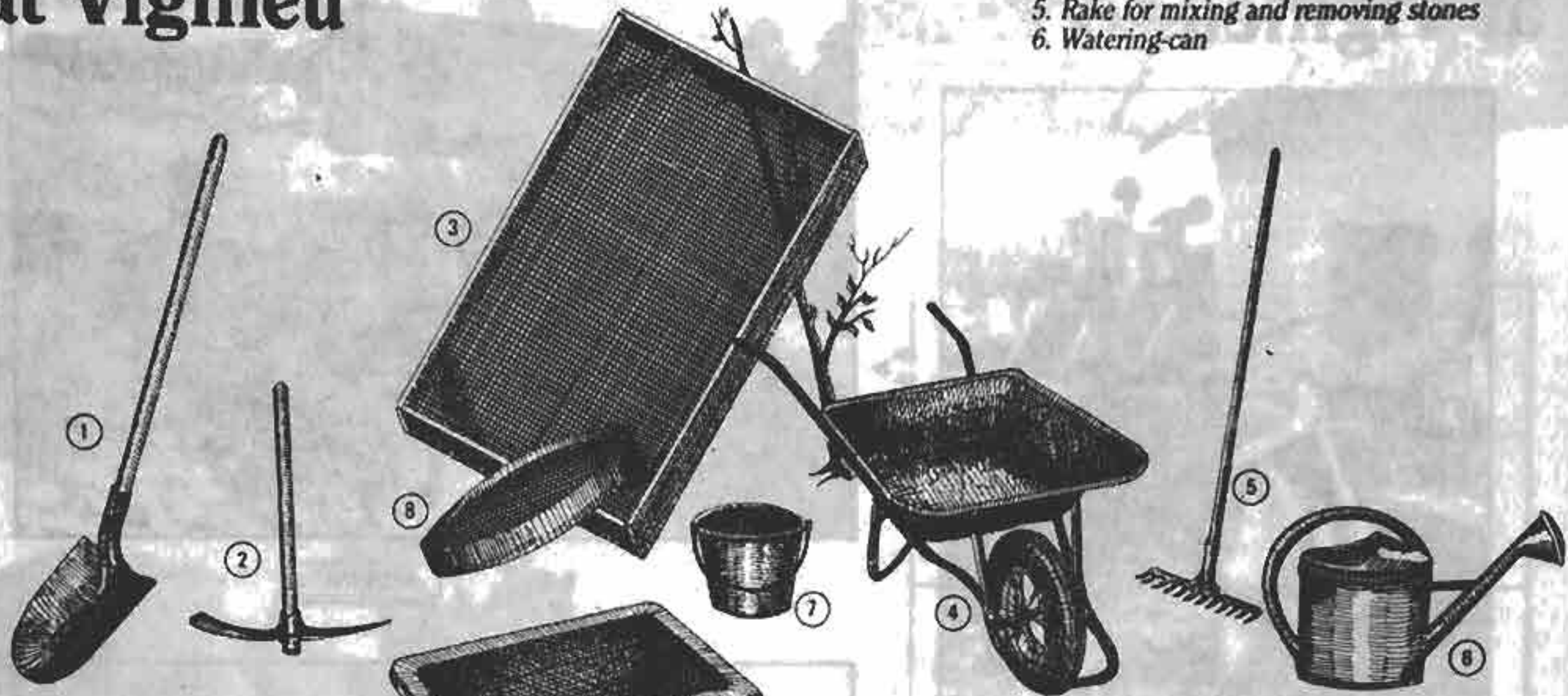

7. Mason's bucket
8. 3 mm mesh sieve
9. Mixing trough
10. Brush
11. "Italian" trowel
12. Narrow trowel

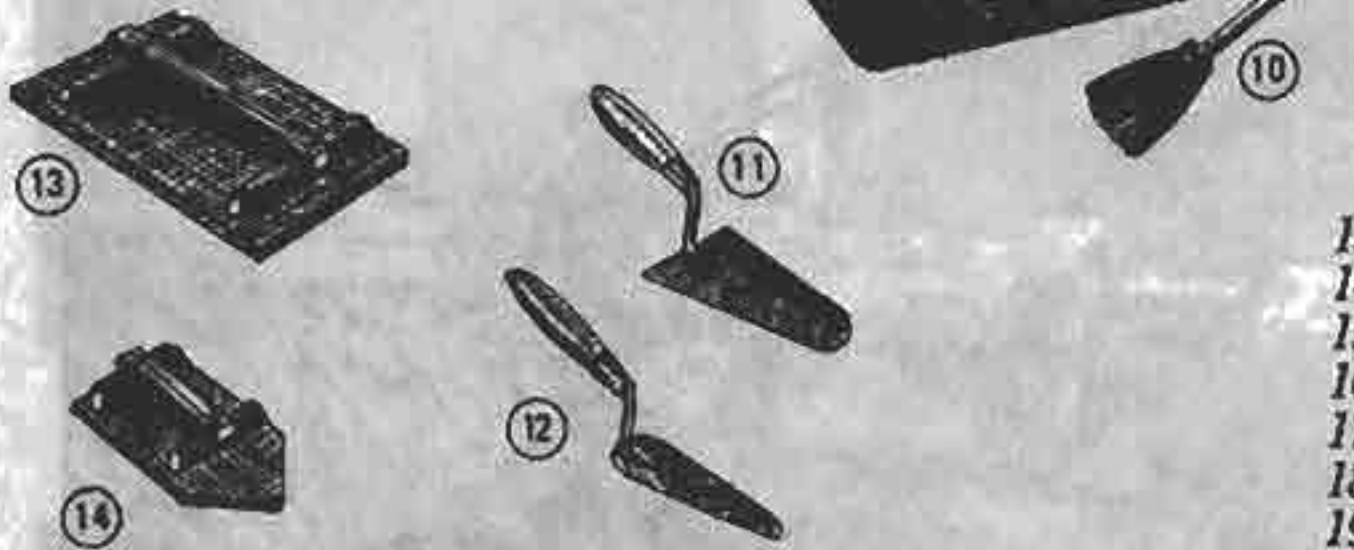

13. Float
14. Pointed float
15. Crowbar
16. Nail-remover
17. Sledge-hammer
18. Mason's hammer
19. Lump hammer
20. Mason's axe
21. Stone chisel
22. Plumb-line
23. 2.5 m straight-edge
24. Large set-square
25. Water-level
26. Spirit-level

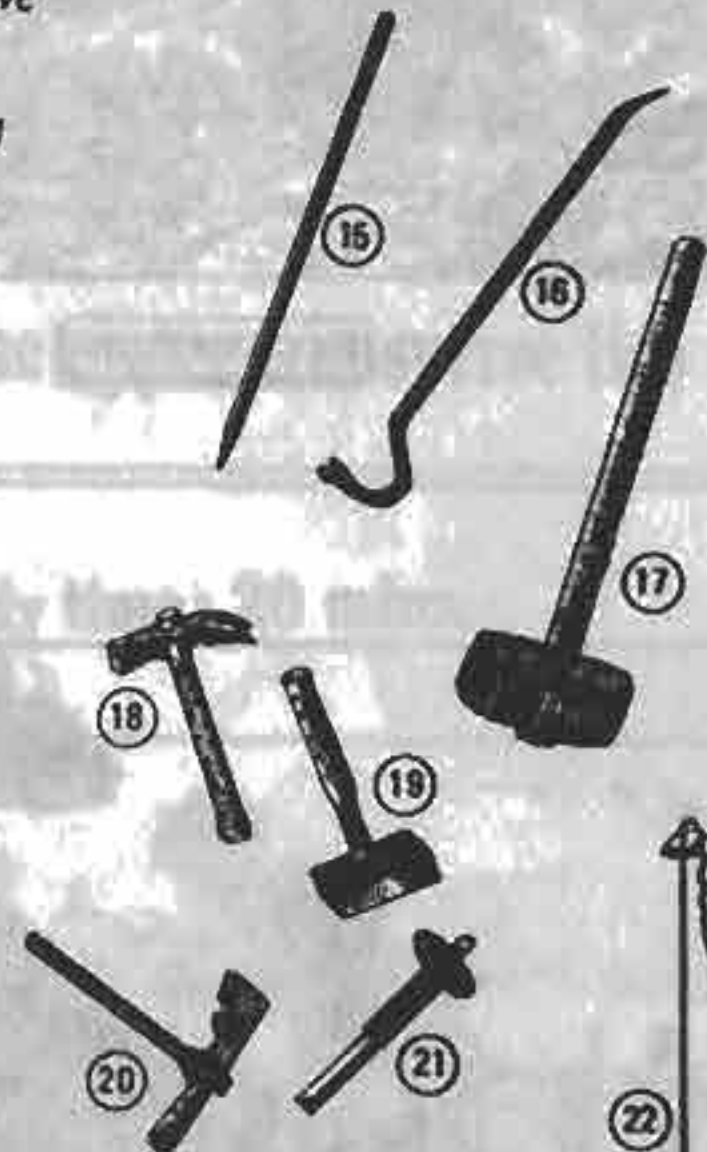

27. "Cordex"
28. Carpenter's pencil
29. String
30. Tape measure
31. Folding measure
32. Compressor (petrol motor)
33. Pneumatic rammer (Ram 30)
34. Spoke shave
35. Wood chisel
36. Saw
37. Hand-saw

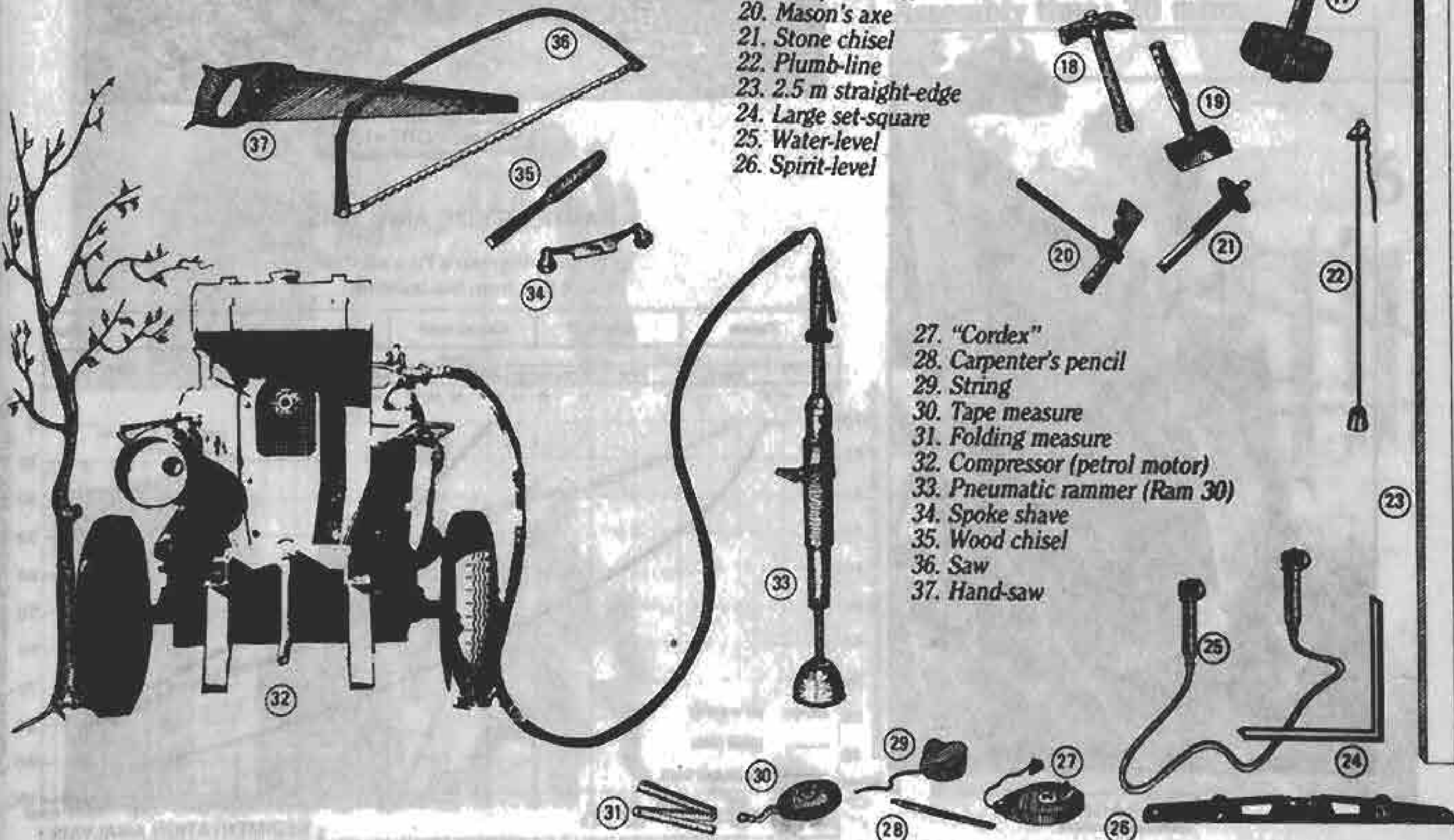

On site at Vignieu



EXCAVATION



SIEVING



TRANSPORTAION



STORAGE

PARTICLE SIZE ANALYSIS

Origin : Vignieu's Pit's earth at 15 m from the building

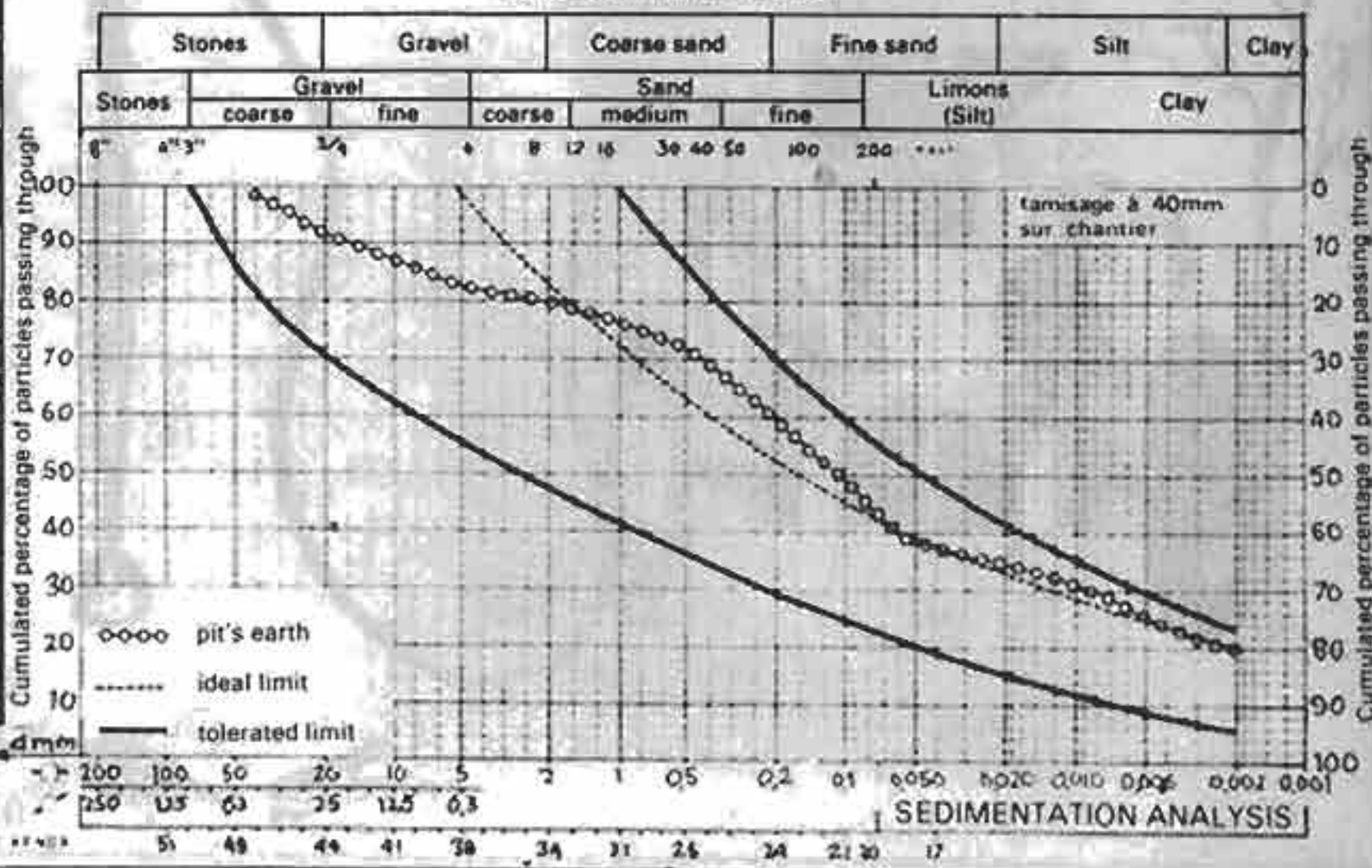

Erecting the shuttering 1



2

3

4

5

1 • Positioning the putlocks

2-3 • the panels

4 • the vertical posts

5 • the horizontal bars

6 • the upper transverse ties

Assembly time: 20 mins.



6

Removing the shuttering

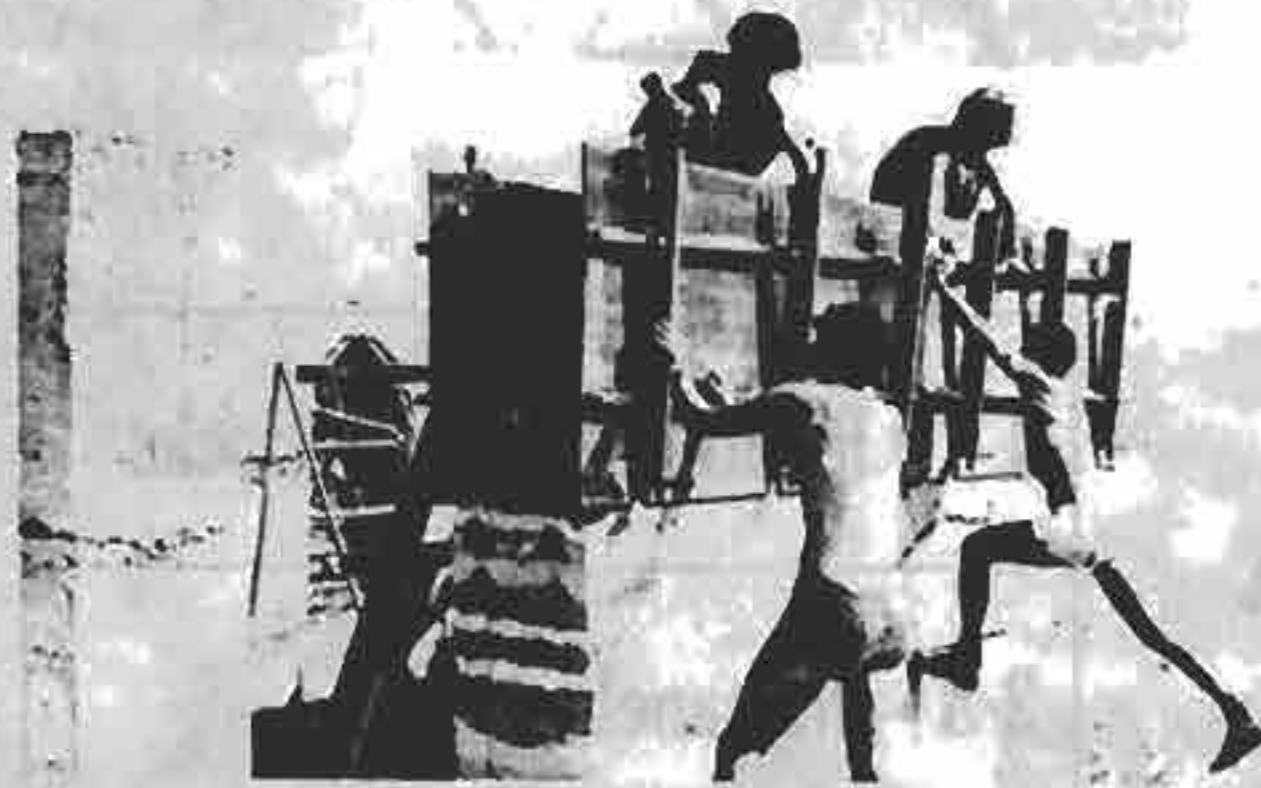

1



2

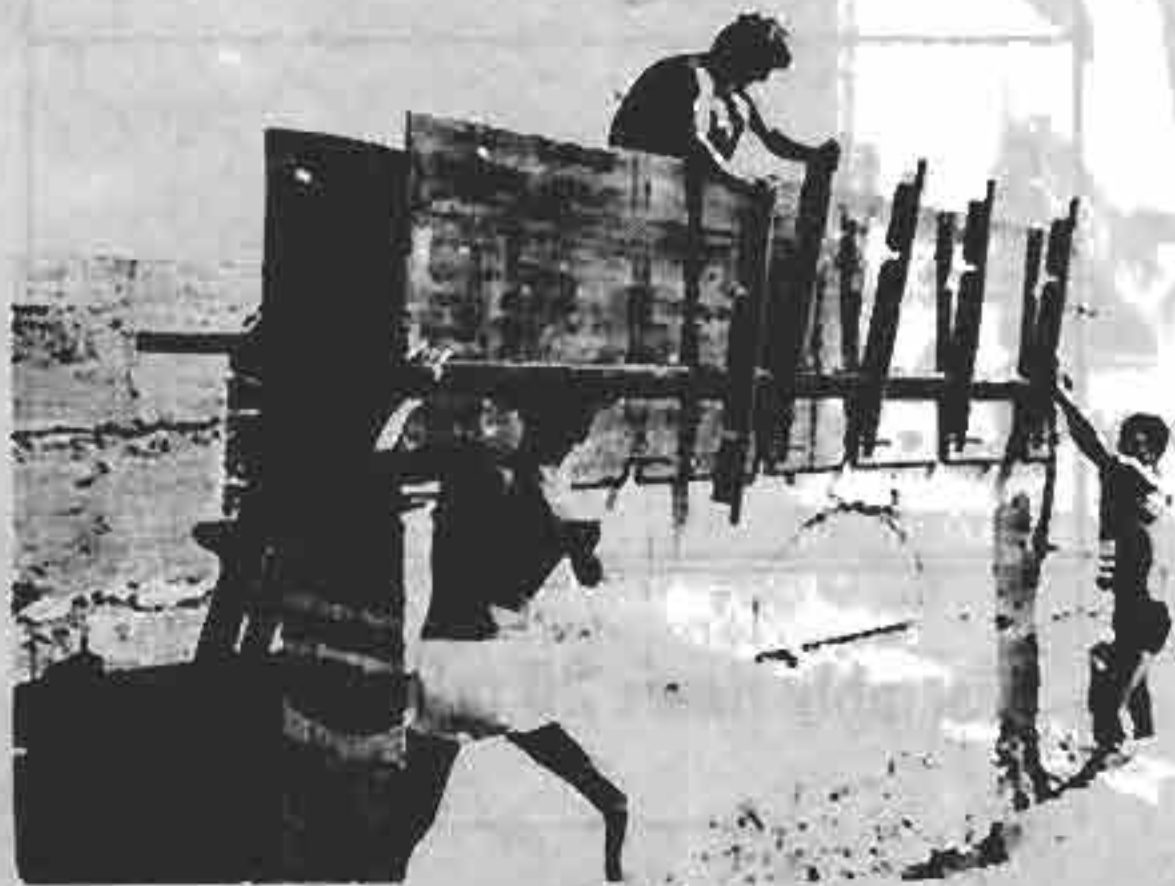

3



4

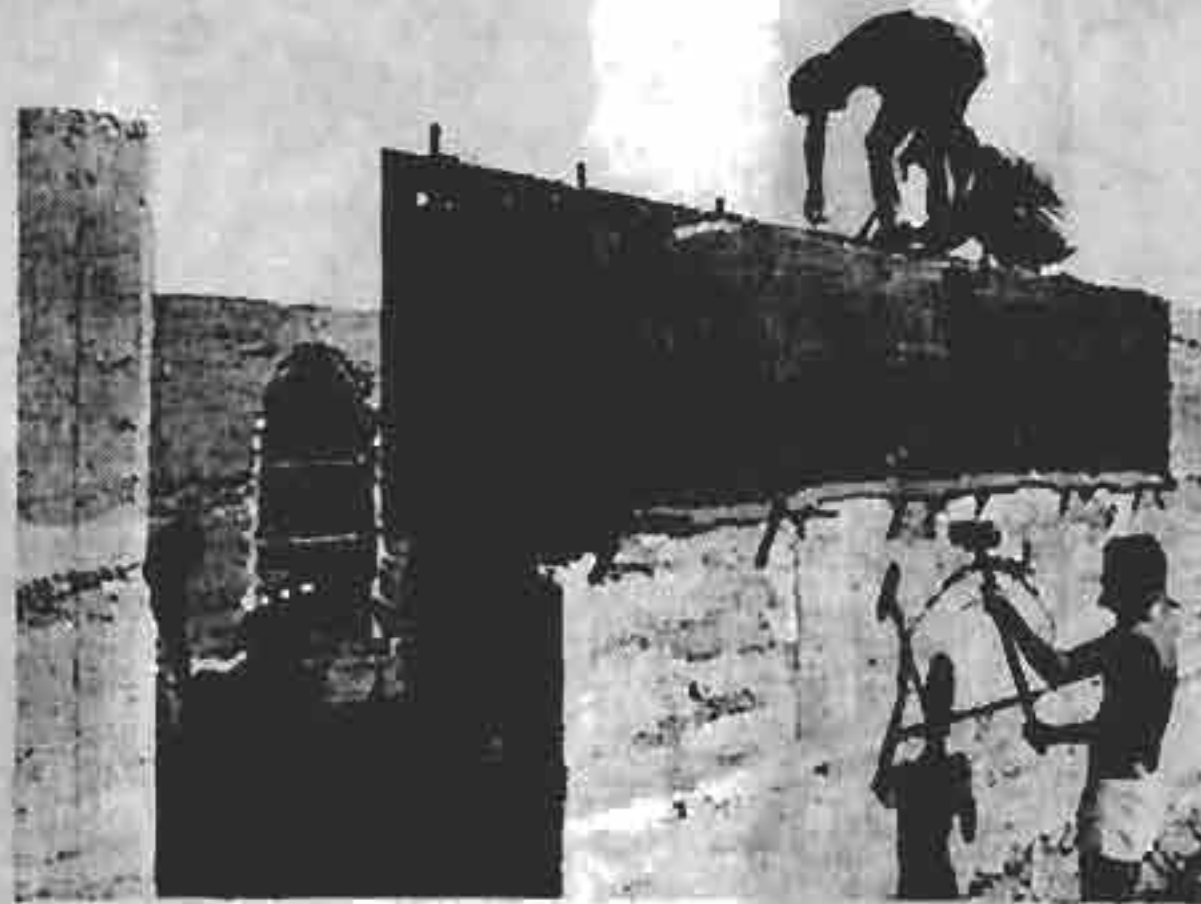

5

Filling the shuttering and compacting



Mixing the earth and filling the formwork



Carrying the earth up



	Optimum water content	Dry weight obtained (max)
STANDARD PROCTOR (550 Kj/m ³)	11.4%	1.96 t/m ³
MODIFIED PROCTOR (2510 Kj/m ³)	11.5%	2.0 t/m ³

The optimum water content was very precise to the nearest 1%.
 On site this was checked in relation to the compaction achieved in practice.
 Good compaction corresponds to the optimum water content found in laboratory conditions

11.5% } for the earth at Vignieu
 with 12.4% - too dry
 with 10.0% - too dry



TAMPING

FIGURE 106

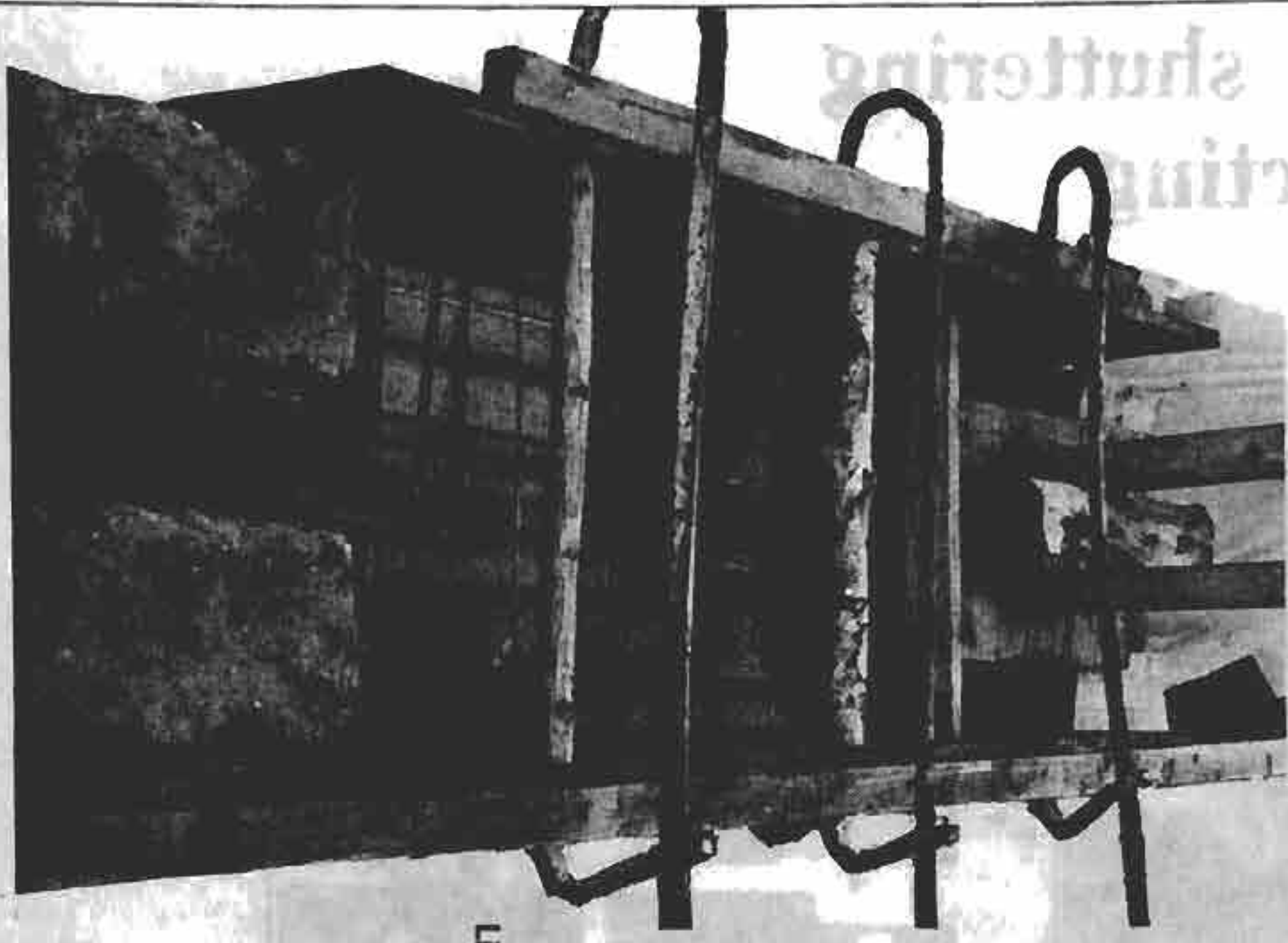

RING-BEAM

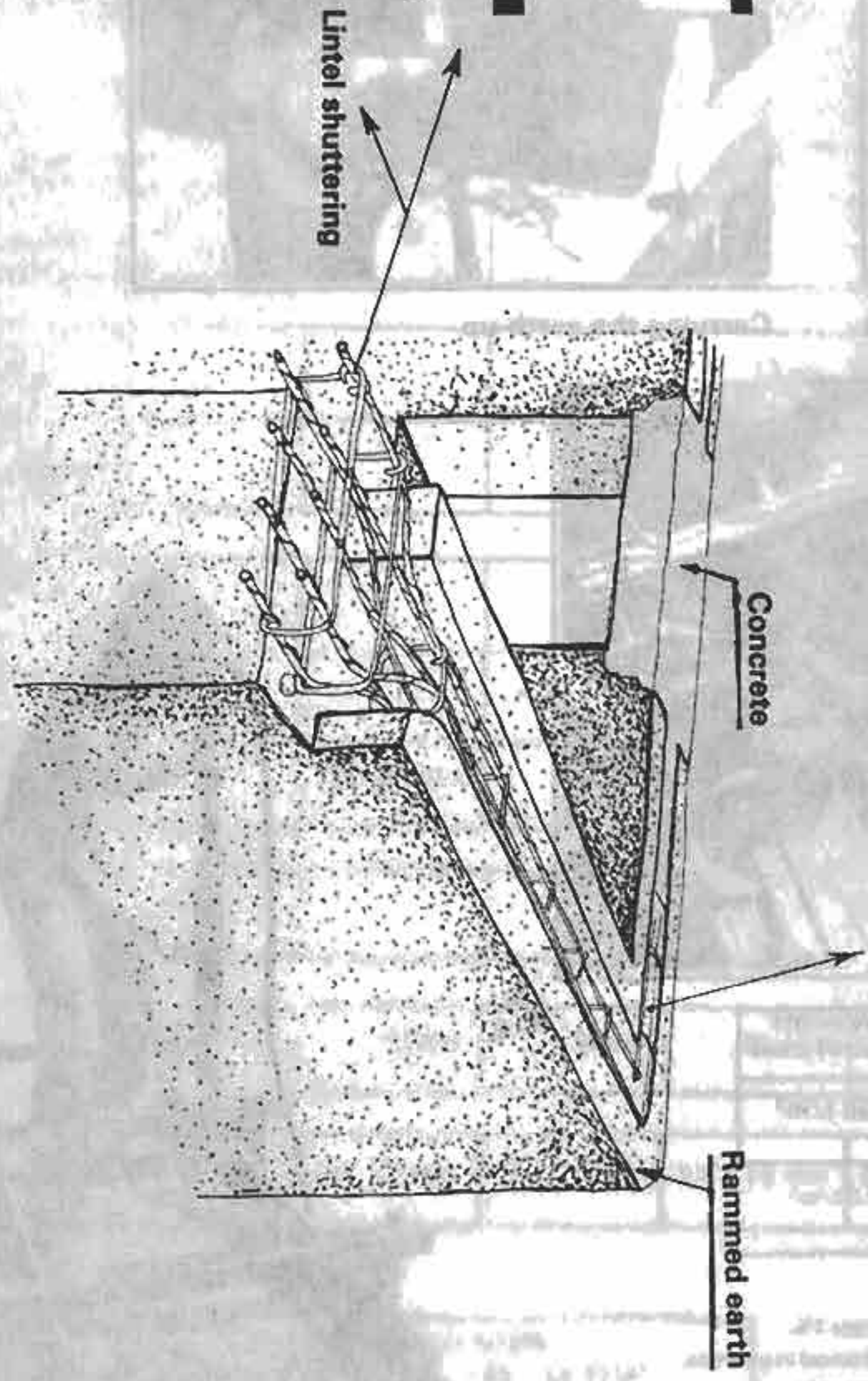

FIGURE 107

On site (mechanized tamping only)

Production Cost corresponding to one shuttering $0.80 \times 3.80 \times 0.60 = 1.82$ $0.60 \times 3.80 = 3.04$

		Worker 1	Worker 2	Worker 3	Worker 4	Worker 5	equipment used
Removing topsoil	Extraction					30 mn	
	Extracting earth	3h		1h		2h	
	Sieving	1h30			1h	30mn	
	Loading into wheelbarrows	1h25			1h	25 mn	
	Transportation by wheelbarrows	1h10		1 h 10 mn			
Erecting formwork	Wall-preparation	30 mn	30 mn				
	Erecting scaffolding	45 mn	45 mn				
	Assembling formwork	20 mn	20 mn	20 mn	20 mn	20 mn	
	Checking perpendicularity	1h	1h				
Preparation and positioning of joints					15mn	15 mn	
Positioning of shuttering for openings						1h	
Carrying the earth up	transferring to buckets				2h 30mn		
	carrying up			2h 30mn			
	spreading it out in the shuttering		2h 30 mn				
Compaction		2h 30 mn					Compressor Pneumatic ram 2h 30mn
Removing the shuttering		20mn	20mn	20mn	20 mn	20 mn	
Total hrs/worker		5h 25 mn	5h 25 mn	5h 20mn	5h 25 mn	5h 20 mn	

Hourly rate:... 17.16 F/H
Equipment costs:... : 134.45 F/M³

According to our Vignieu experience

Cost... 253.60 F/M³

A recent example of a practical experience of stabilized soil cement:
30 houses built with rammed earth

The farming village of Mostefa Ben-Brahim

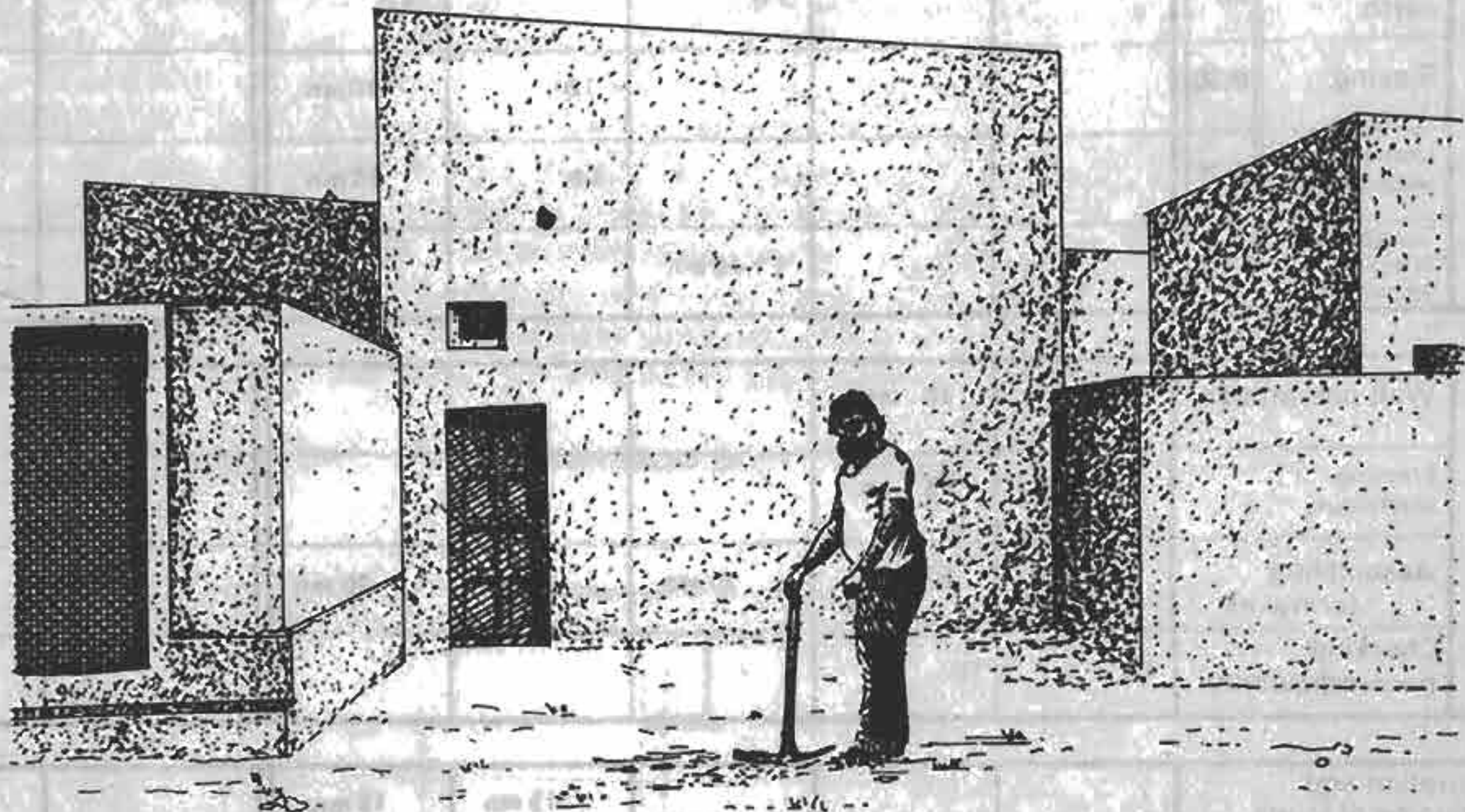

In 1970, the government of Algeria launched a programme the construction of 1,000 farming villages, intended to provide 200,000 units of social housing to be allocated to the agricultural population.

The national construction company of the Ministry of Agriculture, "Chantiers Populaires de la Révolution Agraire" ("People's Agrarian Revolution Building Works"), was particularly well-placed to take an active part in the programme.

The first pilot village was built in 1973 and was located at Mostefa Ben-Brahim, 30 km from Sidi Bel Abbès, in western Algeria; (project leaders: P. Pedroti, D. Helmans, H. Houben).

The village was handed over to the farming population in July 1976 and consisted of 192 houses of 85 m² each built of hollow cement blocks and 30 houses of 120 m² each built of stabilized rammed earth.

CLIMATE

Dry climate on the upper plains. Annual rainfall: 750 mm. Possibly 1 week of snow per annum (5 to 20 cm) and frosts for perhaps 1 month. Average temperatures: from -3 °C to 36 °C. Main direction of wind and rain: N.W.

ARCHITECTURAL DESCRIPTION

The houses had no openings to the north. This provided total protection from harsh weather and at the same time enabled the gardens to be sheltered from the gaze of passers-by, thus respecting the Islamic tradition of privacy. All the houses faced S.S.E.

The housing type selected made no distinction between rural and urban habitat, as the location was a semi-urban one. It took account of certain traditional values and at the same time incorporated a more progressive design. It provided the basic requirements of

comfort and convenience whilst keeping in mind the criteria of families which were to occupy it, moving in with minimal equipment: 7 m³ of cupboard space was sufficient for their needs in this respect.

The houses were handed over to the beneficiaries of the scheme with hot and cold running water, electricity, and a fireplace in the living room incorporating a heat distribution system which allowed the whole house to be heated from one central point (stove or open fire).

On the first floor, one room was intended for the parents and two for children. These three rooms being isolated from the mainstream of daily life allowed for old and sick members of the family to have peace and quiet and for children to have some privacy.

Apart from this very clear demarcation, the house had two entrances, acknowledging tradition in this respect: one for the family and one for visitors. The family entrance opened onto a hall-corridor giving access to the whole house. The bath-room included W.C., shower, wash-basin and storage space. One corner of the kitchen housed a cupboard and the sink, work-surface and oven were located by a window which gave onto the outside living area; the oven was thus accessible through the window, so that cooking could be done from the outside benches. The kitchen gave directly onto the interior and exterior living areas, facilitating access at all times of the year wherever it was decided to eat. The living room communicated thanks to sliding windows with a slightly set-back terrace. In the middle of the living room a sunken area easily enabled 16 people to eat around low tables.

Covered area: approx. 120m² - Garden: minimum 60m² - Habitable area :120m².

FIGURE 110: GROUND FLOOR.

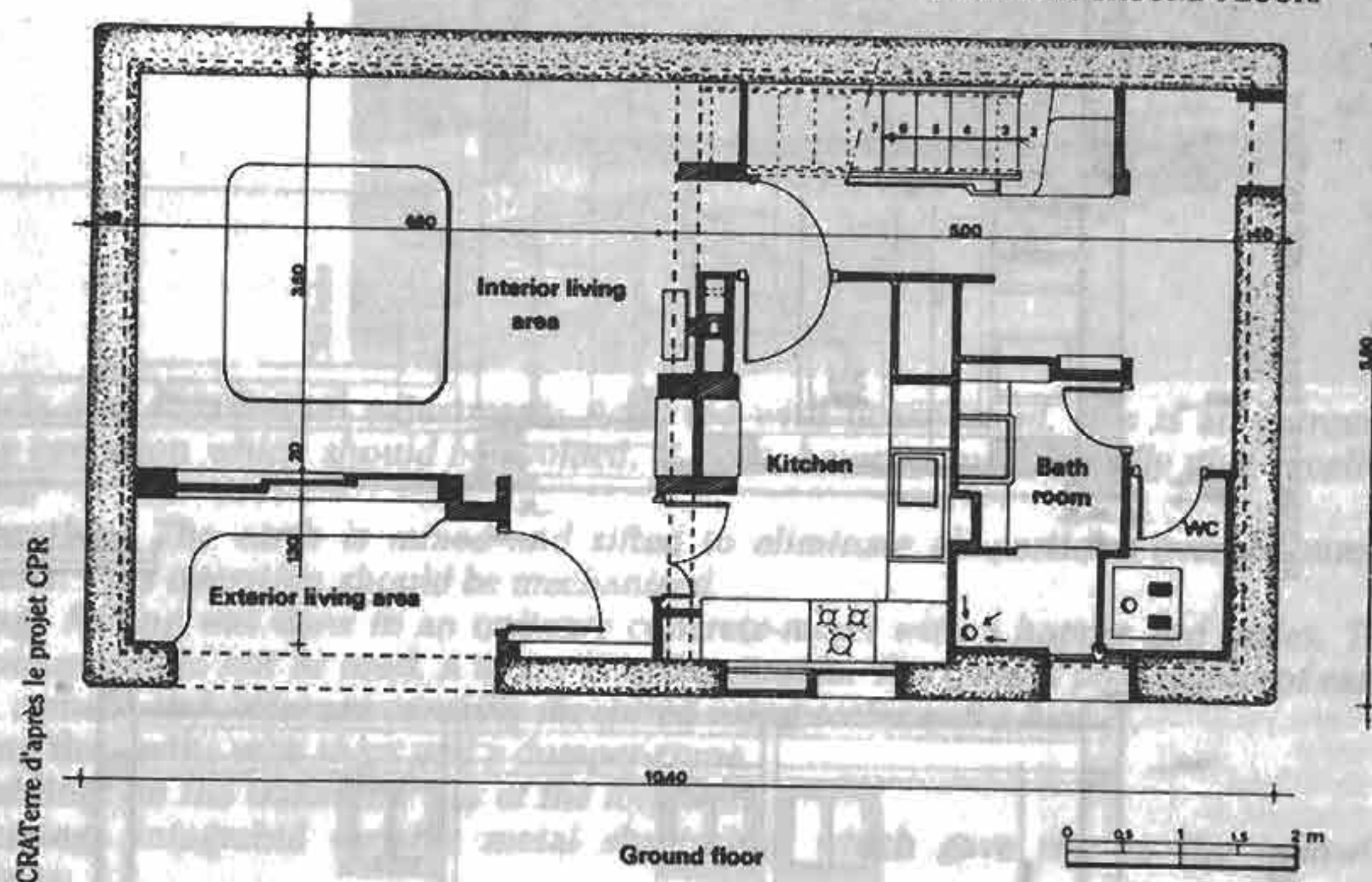

TECHNICAL DESCRIPTION

STRUCTURAL WORK

Foundation: wide strip reinforced concrete (R.C.).

Footings: lightweight hydrophobic concrete.

External ground-floor walls: load-bearing walls 40 cm thick in stabilized rammed earth.

Ring-beam: 10 cm R.C.

Floor: 12 cm R.C.

External first floor walls: Load-bearing walls 30 cm thick in stabilized rammed earth.

Ring-beam and guttering: 10 cm R.C.

FIGURE 111: 1ST FLOOR

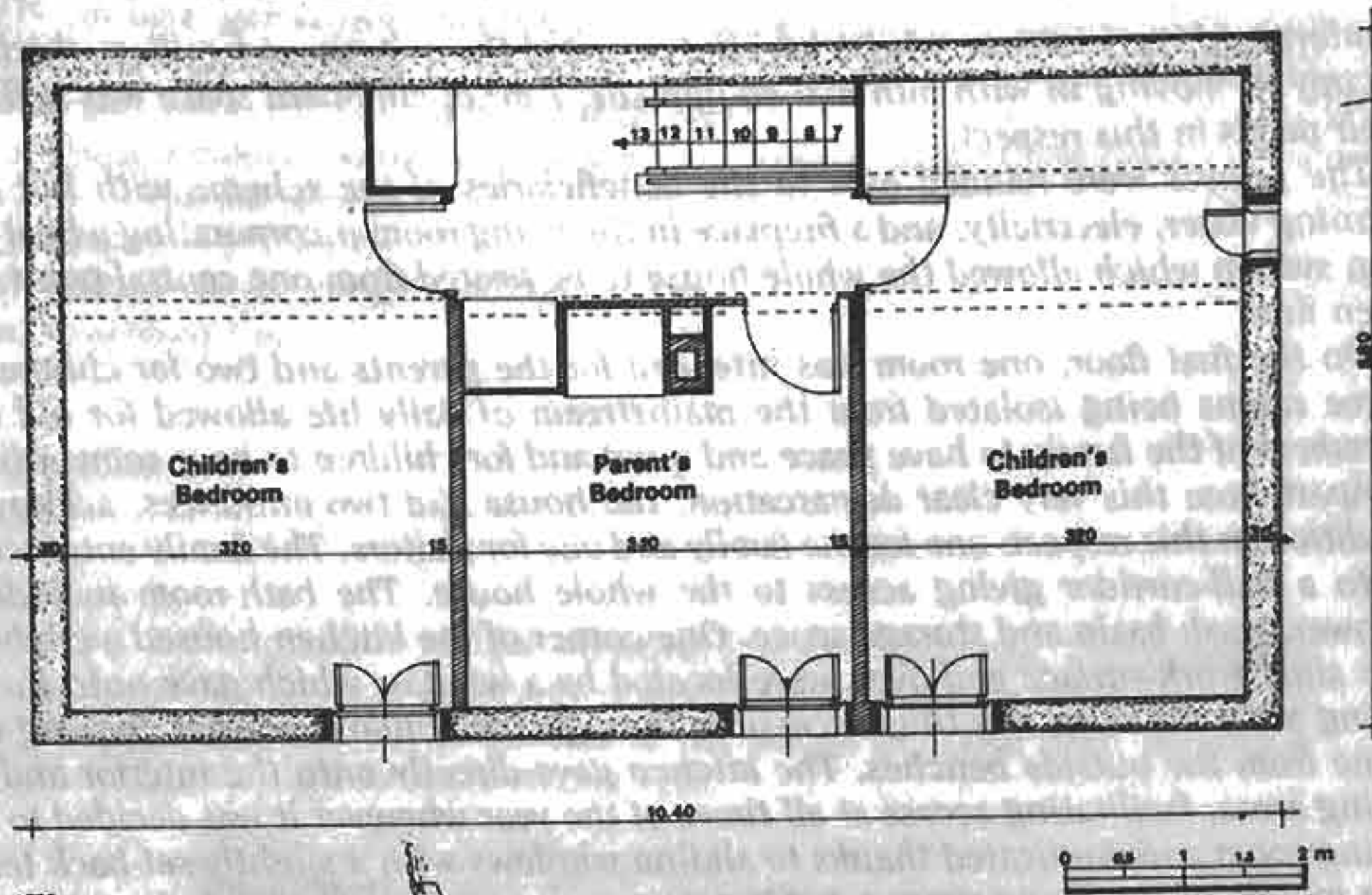

CRATerre d'après le projet CPR

FIGURE 112: TRANSVERSE SECTION

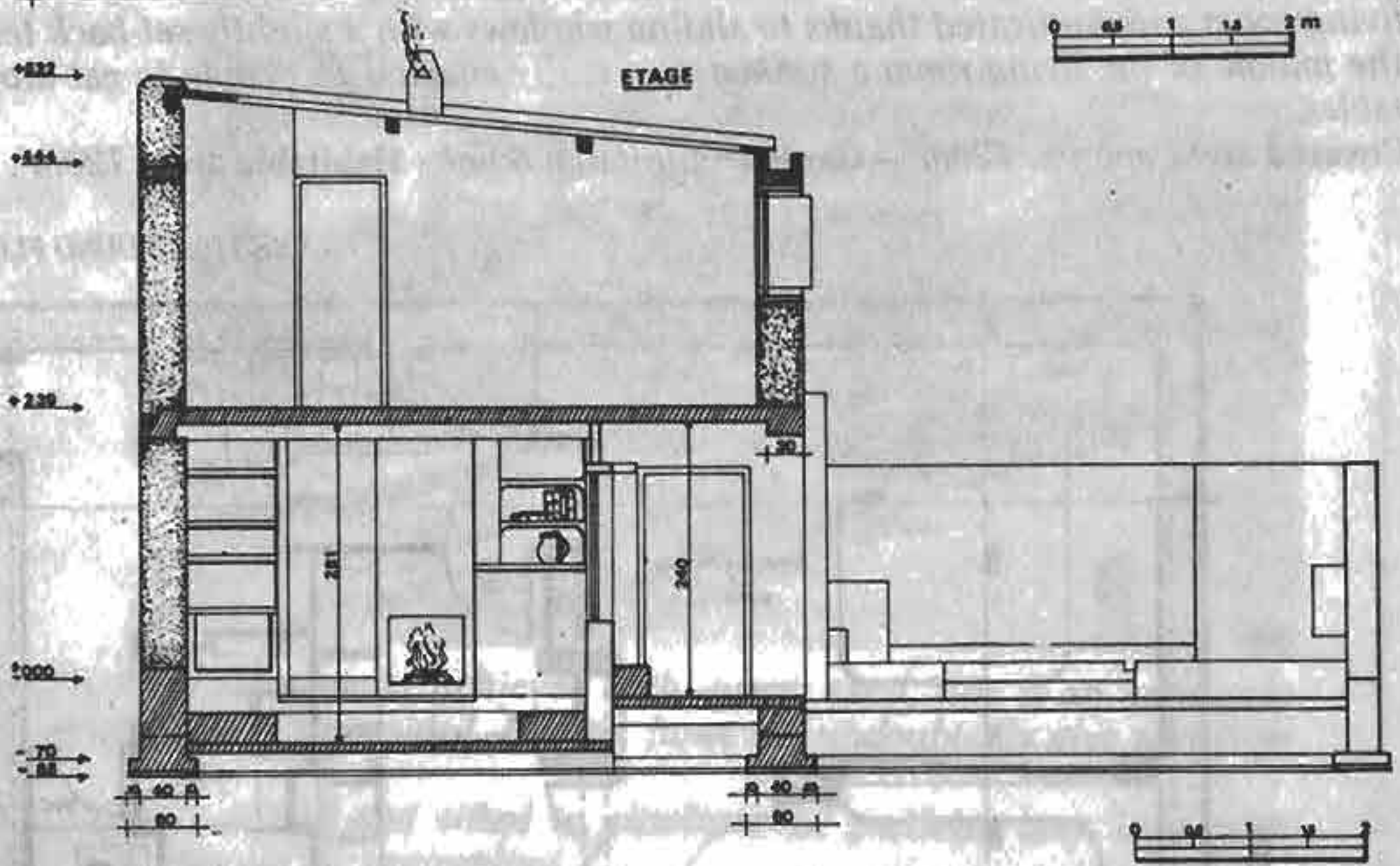

CRATerre d'après le projet CPR

FIGURE 113: LONGITUDINAL SECTION

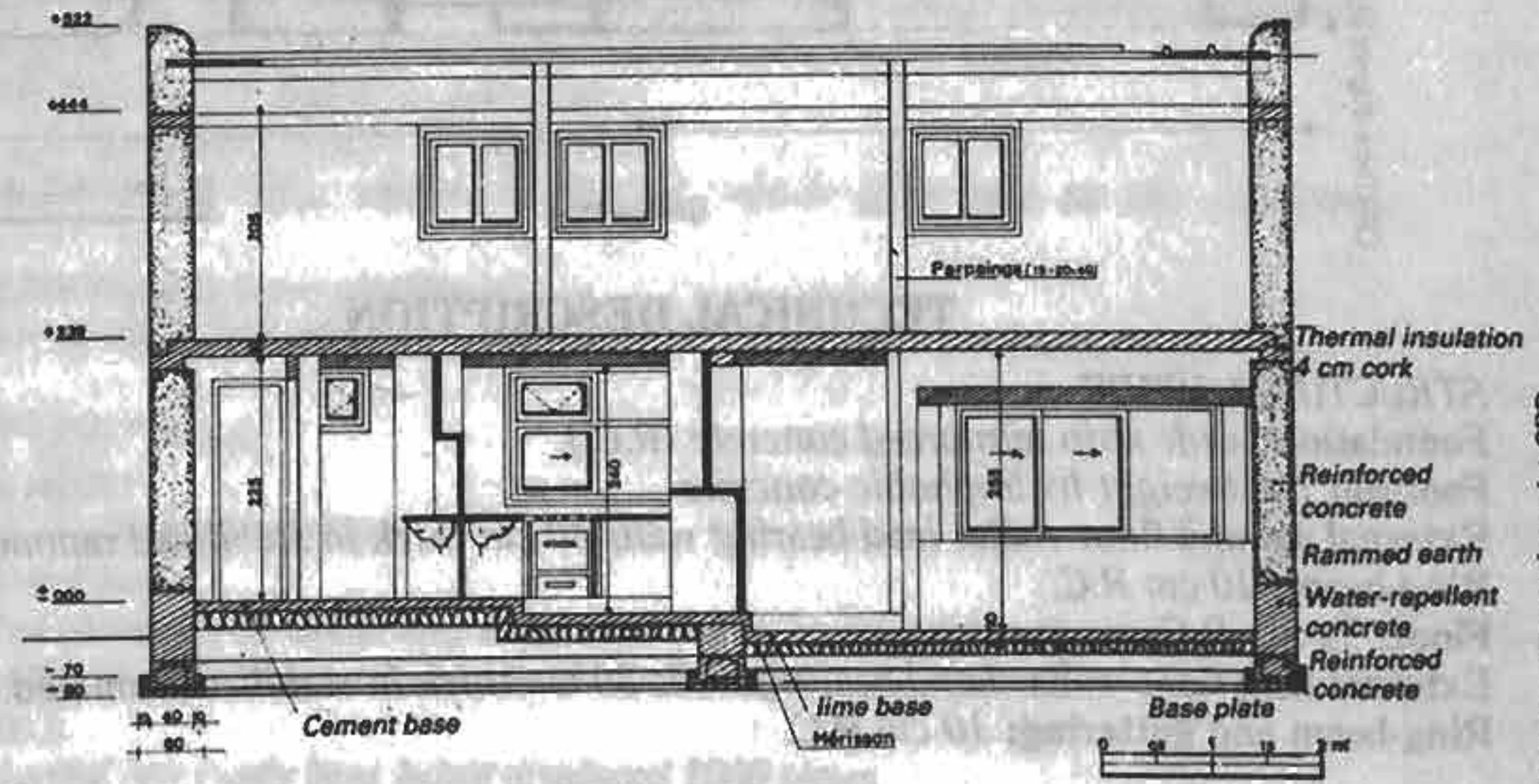

CRATerre d'après le projet CPR

Roofing: wooden timbers; galvanized sheets 0.75 mm thick; thermal insulation in aerated concrete 6 cm thick. Waterproofing achieved by 2 cm lime scree covered with 3 mm "Paxalu" (aluminium- and bitumen-coated roofing felt).

Roof parapet: stabilized rammed earth covered with low-dosage rounded concrete.

Interior walls: hollow cement blocks.

Garden walls: hollow cement blocks.

External render: mixed render, roughcast finish.

Interior render: smoothed lime.

Floors: lime.

Staircase: R.C.

Openings: prefabricated R.C.

Carpentry: wood.

EARTH TECHNOLOGY

Excavation: a bulldozer was used to excavate the earth in a pit 2 km away. This operation has to be carefully organized to avoid problems of sinking in during the rainy season, as well as problems of clay thinning out as a result of the action of active lime, making it difficult to use after being stocked for more than a year.

FIGURE 116: A SEARCHING TEST.

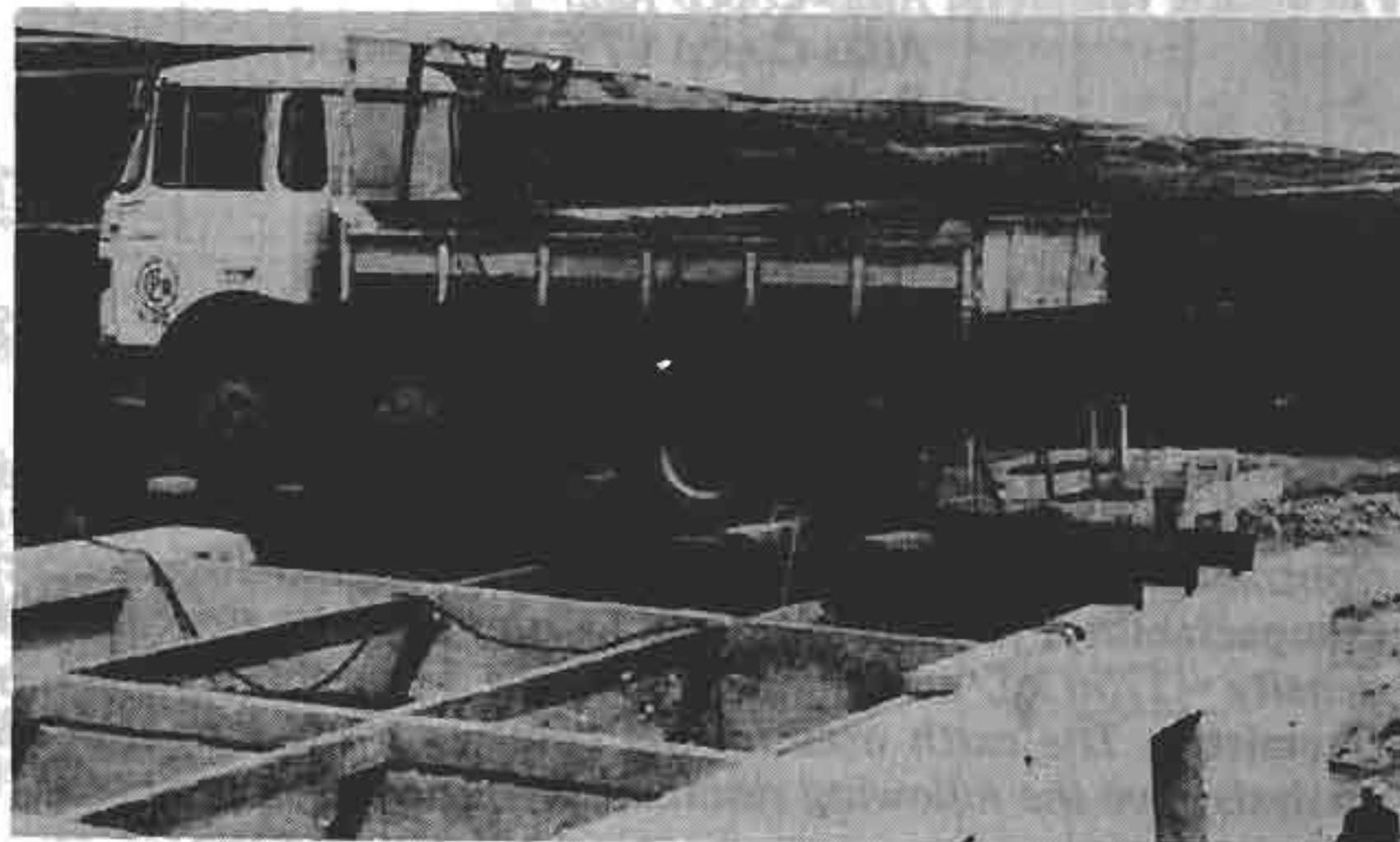

Particle size distribution adjustment: Achieved with quarry sand, this is an extremely costly operation which should be avoided. It does, however, undoubtedly give excellent results.

Preparation: The earth is mixed and sifted to eliminate all particles over 10 mm in diameter. This operation should be mechanized.

Mixing: Mixing was done in an ordinary concrete-mixer with a hopper and scales. This technique should not be used. A mixer is indispensable. The correct proportions of earth, sand, cement and water are carefully measured using scales and a funnel.

Raising the earth: with skips and a dumper-crane.

Scaffolding: on the transverse ties of the formwork.

Shuttering: integrated variable metal shuttering, which gave rise to the following problems:

- 1) Very heavy investment to be amortized;
- 2) Deformation of the shuttering as a result of the enormous pressures exerted during tamping;
- 3) Weight (50 kg per panel);
- 4) Difficult to adjust
- 5) Difficulty in holding plumb-line;
- 6) Poor finish at joints;
- 7) Prefabricated elements for doors and windows have to be minutely adjusted;
- 8) Problems with the shuttering holes in the transverse ties (removal, getting blocked, cracking etc.);
- 9) Metal shuttering can easily bear being displaced 1000 times.

Tamping: the material is tamped in layers of 8 to 10 cm thick using the following methods:

1) small metal hand rammers are used along the edge of the forms to achieve a very hard, strong layer;

2) in the middle, a first rough tamping is done with 12 kg cast iron rammers, with an Atlas Copco Ram 30 rammer which does the job of 10 manual rammers.

Renderers: The walls have to be completely spiked. From this point view a rough-finish shuttering would be an advantage. Even mixed renders and lime-based renders failed to adhere to the wall. One should be bold enough to use earth-based renders stabilized with lime. These should be left to "rot" for three weeks, only after this will the render "stick".

MACHINERY USED

Mixer: Rock MHC 75 T, 750 litre capacity, with filling hopper and scales. Electric control panel. 40 HP engine.

Dumpers: Elba EDF 16, 1.5 tons. Tripper brake.

Dumper crane: Elba. 6.5m reach. 400 litre skip. Pouring height: 5.6m

Pneumatic rammers: Atlas-Copco Ram 30;

Atlas-Copco VT 6 compressor;

Surface pressure: 8kg/cm²

Output: 11 m³/minute

THE MATERIAL

Particle size distribution: corrected by adding 50% quarry sand. The particle size distribution then follows the same curve as the ideal curve (fig. 117).

Plasticity: Plasticity index $I_p = 22$ / Liquidity index $II = 40$ / Plasticity limit $L_p = 18$ / Contraction limit $L_c = 12.5$ / Plastic zone material 10 : satisfactory / average activity.

Compactability: Normal Proctor / Optimum Water Content (OWC) = 15.6% / maximum density = 1750 kg/m³ dry volume / Zone 3 = highly satisfactory.

Chemistry: The earth used for the blend was a red montmorillonite clay. The chemical analysis gave the following results:

Comments	%	Ingredients
Insolubles	68.8	Excellent
Silicates	10.7	Good
Sulfates	0	Ideal
Chloride	0	Ideal
Iron oxide	1	Poor, good
Carbonate	14.2	Excellent
Water constituent	5.7	Well-defined montmorillonite
Alum	19.2	Plastic clay
Al/Silicon	1/2.5	Altered montmorillonite
Total silicon	58.1	Perfect
Magnesia	0.7	Very good
Conclusion		Highly acceptable for SSC

Stabilization: the earth is stabilized with cement at 120 kg/m³ of compacted earth (i.e. 6.2%).

Characteristics of stabilized soil cement obtained:

- Dry volume = 1920 kg/m³
- Following 28 days curing:
- Dry compressive strength: 52 kg/cm²
- Wet compressive strength: 30 kg/cm²
- Dry tensile strength: 6.30 kg/cm²

PARTICLE SIZE ANALYSIS

SOURCE: SIDI BEL ABES

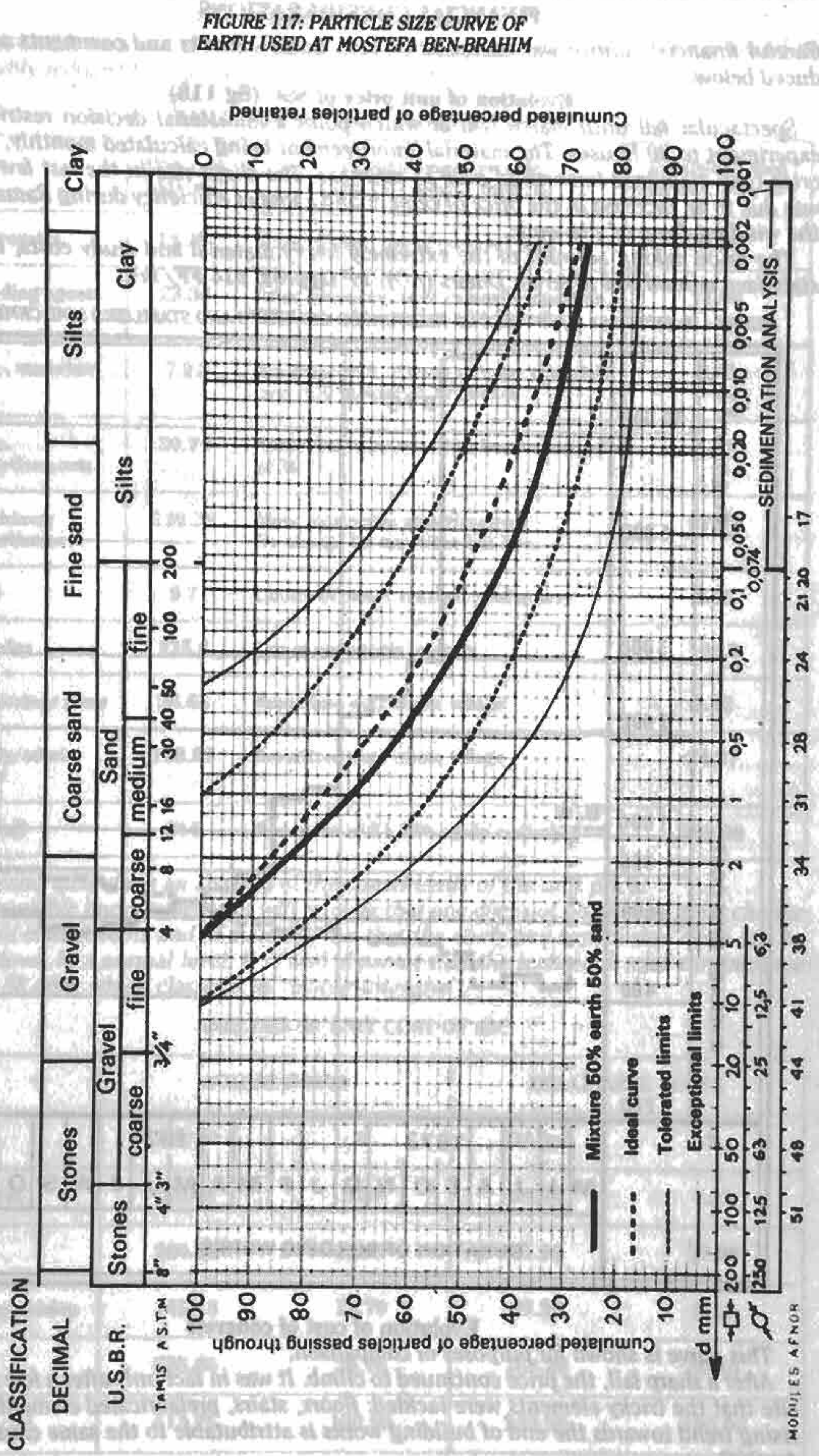

FIGURE 117: PARTICLE SIZE CURVE OF EARTH USED AT MOSTEFA BEN-BRAHIM

FINANCIAL CONSIDERATIONS

Careful financial control was exercised on site. Some extracts and comments are reproduced below.

Evolution of unit price of SSC (fig 118)

Spectacular fall until March '74, at which point a ministerial decision restricted the experiment to 30 houses. The material amortization being calculated monthly, the cost price then stabilized (amortized over 17 months). The slight rise in the last few months was due to an increase in the price of cement and a loss of efficiency during Ramadan and the winding-down of site-work.

The price, taking account of the extremely heavy material and study costs, therefore stabilized around 614 Algerian Dinars (AD)/m³ (approx. 614 FF/m³).

FIGURE 118: MONTHLY COST PRICE OF REINFORCED CONCRETE AND STABILIZED SOIL CEMENT

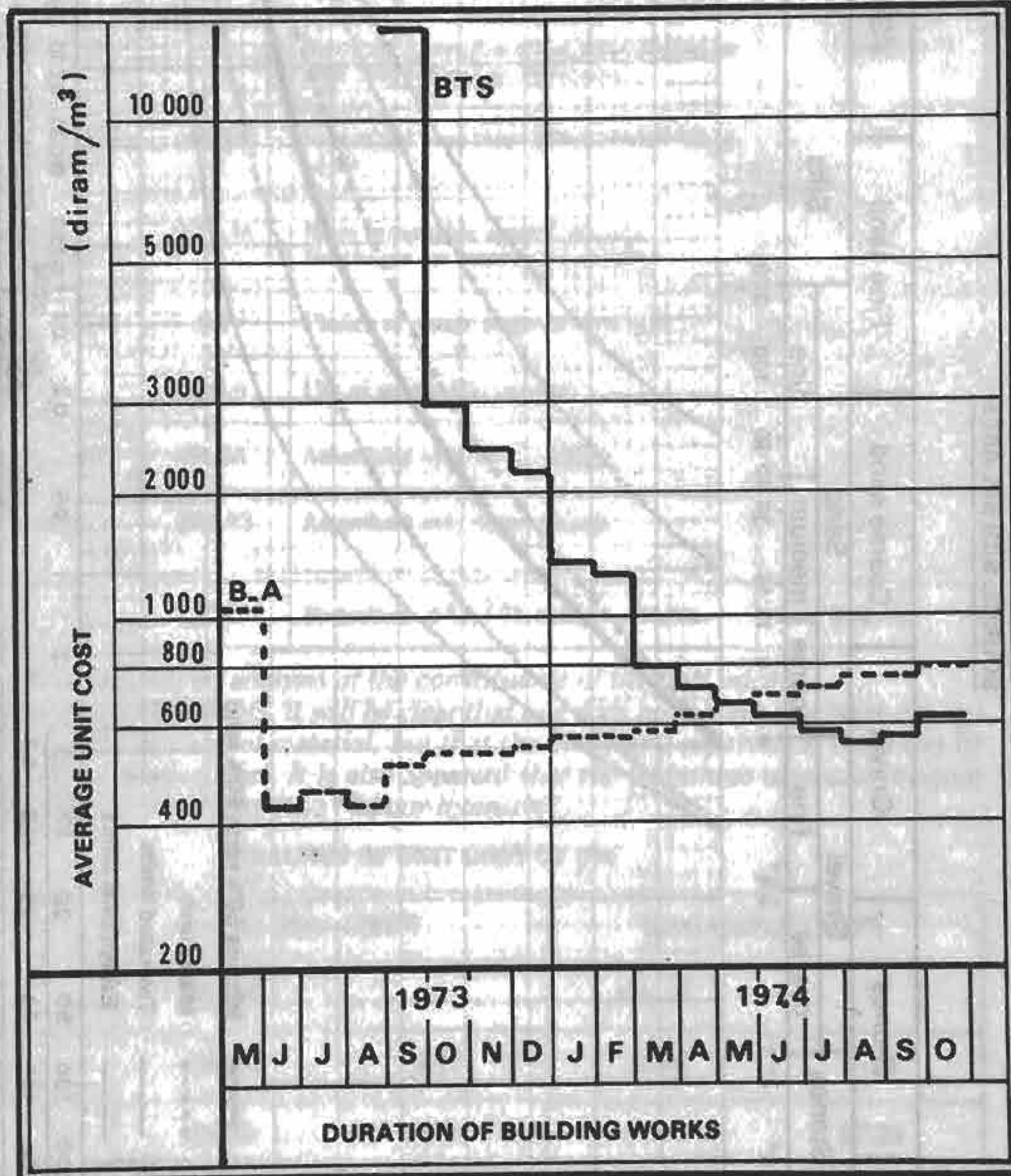

Evolution of cost of concrete

This curve is shown for purposes of comparison.

After a sharp fall, the price continued to climb. It was in fact only after a few months on site that the tricky elements were tackled: floors, stairs, prefabricated elements, etc. The rising trend towards the end of building works is attributable to the same causes as cited for SSC.

Unit Price Analysis

The first table sets out the unit price costs obtained on site. The cost price could be considerably reduced taking account only of extremely practical improvements.

ANALYSIS OF UNIT PRICE OF SSC

	Item	Unit cost (AD/m ³)	Possible improvements (for this specific project)	Possible revised unit cost (AD/m ³)
1.	Aggregates	13.30.	More efficient use of quarried sand	9.98
2.	Bonding agents	23.36	After laboratory tests cement proportion 62.5 kg/m ³ instead of 120 kg/m ³	11.68
3.	Misc. materials	7.21	Amortization of some of these materials over 300 instead of 30 houses	3.63
4.	Misc. amortizations	59.72	Amortized over min. 300 houses instead of 30	5.97
5.	Machinery amortization	129.38	More reasonable amortization. No charge for machines left idle.	67.28
6.	Fuel	9.7	Choice of closer crushed sand quarry	4.85
7.	Salaries	225.6	Use of pneumatic tampers	169.2
8.	Laboratory costs	36.65	Amortized over whole village	3.12
9.	Study/admin costs	108.83	Amortized over whole village	24.27
	Overall	614	Reduction of 51.14% easily realisable	299.98

The second table gives an analysis of the constituents of the unit price.

In the possible improvements, it will be clear that one does not obtain any great change in the % of constituents and of material, but that the study and supervision costs can be brought down to a normal level. It is also apparent that the technique used can increase labour to 56.40%, which classes it as "labour-intensive".

ANALYSIS OF UNIT COST OF SSC

	ACTUAL COSTS		REALISABLE COSTS	
	DA/m ³	%	DA/m ³	%
Constituent	36.66	5.97	21.66	7.22
Material	206.01	33.57	81.73	27.25
Study/supervision	145.48	23.70	27.39	9.13
Labour	225.60	36.76	169.20	56.40
Total AD/m³	613.75	100.00	299.98	100.00

STATISTICS RELATING TO APPLICATION

Operation	Time taken (hrs)	Criticism and improvement	Estimated revised time taken
Shuttering	448	Inadequate and poorly-designed shuttering system. Lack of experience. Improvement of up to 50% possible.	224
Removal of shuttering	168	Bolts to be replaced by pins. Better transverse tie system. Improvement possible 30%.	118
Filling and tamping	560	Filling using buckets. Manual tamping. Could be reduced by 60% if using dumper, crane and pneumatic rammer.	224
Removal of tubes	128	Ties very badly-designed. Removal using drill. Improvement possible 30%	40
Filling of holes	32	Ditto	32
TOTAL	1136	Cubic total 50 m³ Improvement possible 48%	638
Total time per m³	27	Can be reduced to rate equivalent to normal masonry building i.e. 15 hrs.	13

FIGURE 114: APPLICATION OF SSC:
DETAIL OF SHUTTERING

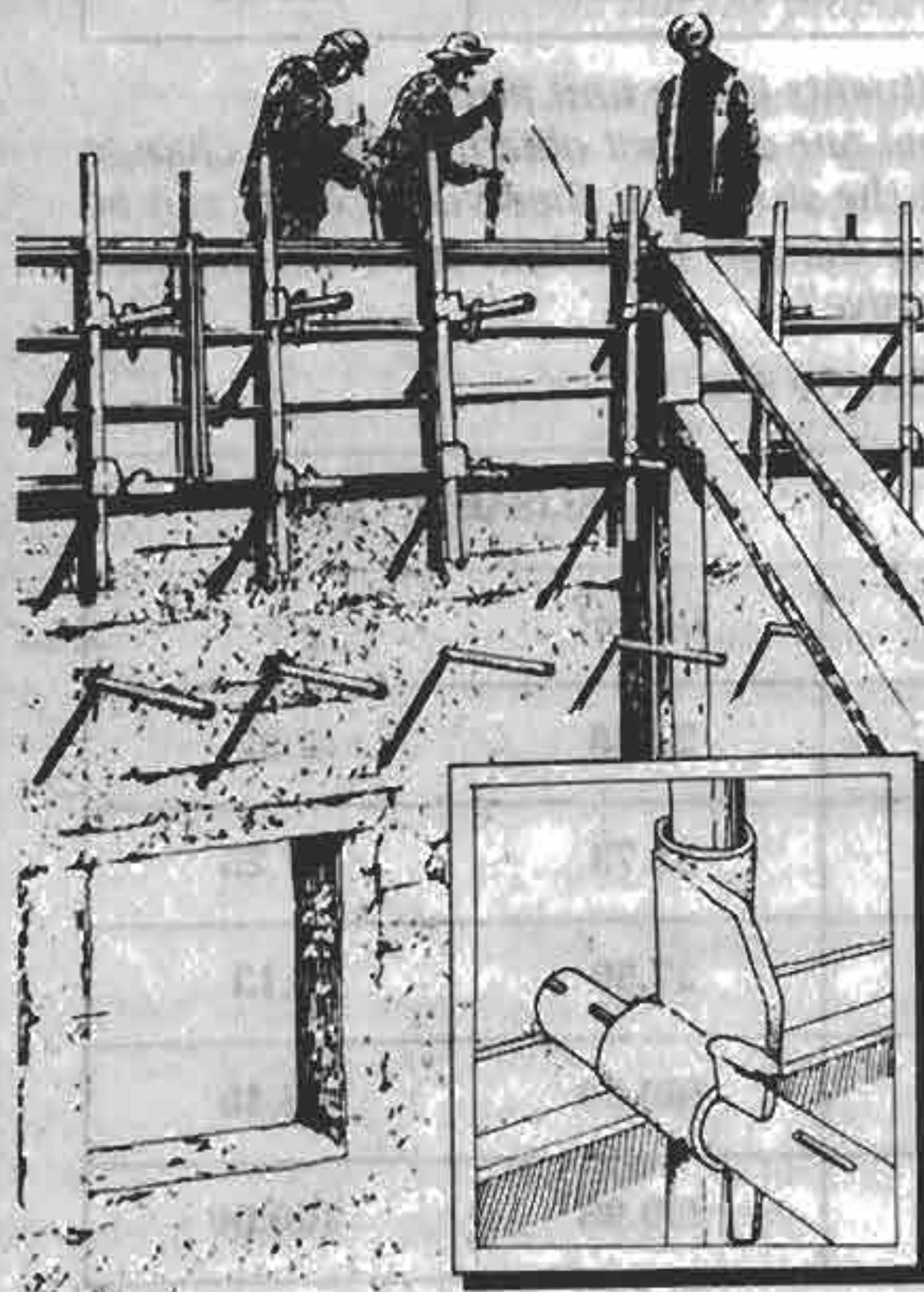

Pierre Bonneville

ECONOMY IN USE OF CEMENT

	SSC	Hollow cement block
Proportion of cement	120 kg/m ³	250 kg/m ³
Material per m ³	1 m ³	0.5 m ³
Final cement consumption	120 kg/m ³	125 kg/m ³
Possible consumption	60 kg/m ³	125 kg/m ³
Theoretical saving per house	3 tons	
Saving for 300 house site	900 tons or 225,000 AD in foreign currency	
Comment	The result is highly debatable. To obtain spectacular savings the whole design would have to be revised and complete reliance placed in earth.	

FIGURE 119: ZERALDA



CRATerre

FIGURE 120: PETROPOLIS



CRATerre

A Variation : poured liquid earth

According to this method the earth is poured in liquid state, like concrete, directly into the shuttering.

THE ZERALDA EXPERIENCE

In 1972/73 three houses, intended for forest wardens (fig. 119), were built at Zeralda (Algeria) in the grounds of the President's residence (known as "La Forêt des Planteurs").

They were built by the Agrarian Revolution Popular Building Works and since building in earth at the time not only did not figure in official standards and but was in fact prohibited, they were to serve as demonstration buildings. It was probably more out of ignorance of the technology for applying the material than out of any intention to conduct a probing scientific experiment that poured earth was chosen, but the results are no less interesting. Building work took place during the months of November, December and January. Neither the application nor the proportions used were subject to any verification.

APPLICATION: The future building was completely surrounded by wooden shuttering, a very heavy investment since the shuttering for the three houses was equivalent to the price of one of them. The earth was brought in wheelbarrows, so the ramps needed to be slightly sloped. The shuttering was moved along every three days, allowing one day for pouring and two for drying out.

The earth used was very poor and mixed with top soil. It was stabilized with 7 to 8% hydraulic lime. When lime was in short supply it was replaced with cement. The mud was poured into the shuttering in 30 cm layers and the walls were 40 cm thick. Two days after pouring the shuttering was removed.

Many cracks had appeared, but once these had been filled in, the walls acquired a quite remarkable consistency. They stabilized after approximately 6 months. They were immediately white-washed but no external render was applied.

In conclusion: despite breaking all the rules as regards application, the technical results proved most searching, but the finishing needed to be completely revised.

THE BRAZILIAN EXPERIENCE

In 1943 houses were built at Petropolis using stabilized soil concrete in mud form. A concrete pump was used to fill the shuttering.

The houses were left uncovered for 6 months. At the end of this period all the cracks were carefully repaired and secondary building works started. The houses are currently still in use and in perfect condition (fig. 120).

FIGURE 121: PRACTICAL EXPERIENCE OF "ABOBE POURED BLOCKS" IN THE UNITED STATES
STAGE 1: MOULDS 1 × 0.4 × 0.4 M ARE PLACED ON THE WALL AT REGULAR INTERVALS THEN FILLED WITH A LIQUID EARTH MIX. THE MOULDS ARE REMOVED AFTER A FEW HOURS.

STAGE 2: AFTER DRYING OUT, THE INTERVENING SPACES ARE FILLED WITH EARTH, USING THE TWO SMALL SIDE-PANLES TIED TOGETHER WITH WIRE WHICH WILL LATER BE CUT.

THIS TWO-STAGE PROCESS PREVENTS SHRINKAGE CRACKS FROM FORMING.

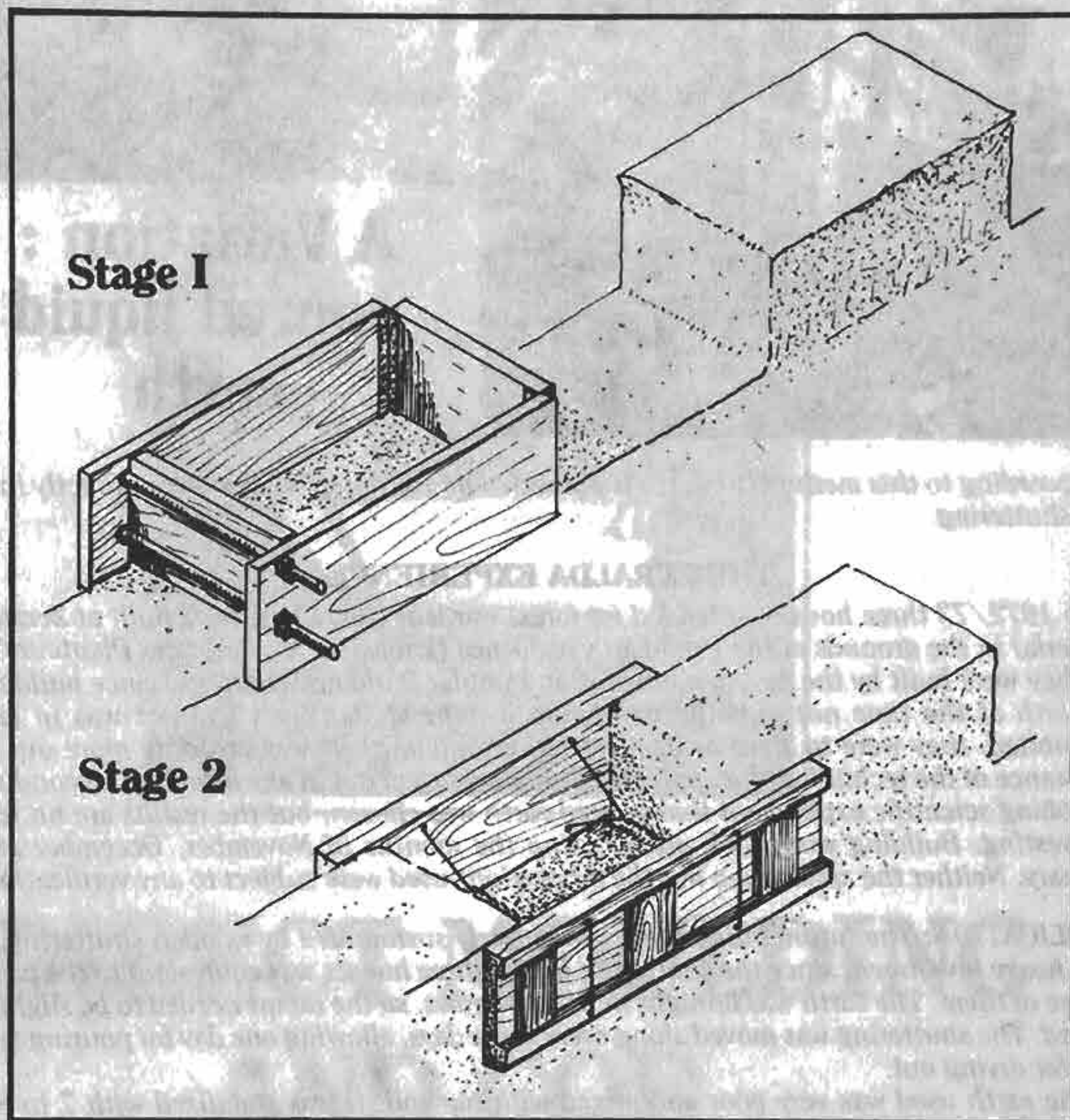

KEB



2. DIRECT MOULDING AND COB

With this technique earth is built up directly without the use of moulds or shuttering, thanks to its plasticity when wet.

Rather than being used to infill a framework as in lath and plaster, the earth is shaped directly in a way similar to making pottery.

The material being in a plastic state is therefore essential to the application of this technique. A consistency which is neither too wet to be shaped nor too dry to have cohesion must be achieved.

The most remarkable applications of this technique are to be found in black Africa and the Yemen and these sometimes attain a degree of architectural subtlety and display a mastery of the material which it would be difficult to equal. Our review therefore presents building examples from these areas, although this building method is wide-spread the world over, and more particularly European developments of this technique.

BLACK AFRICA

Direct moulding is wide-spread in the Sahel and equatorial regions despite the fact that buildings in these areas have to withstand the heavy, often torrential, rains of the wet season. In rural areas it is used to build round houses and grain-stores, and in towns mosques and housing blocks.

There has been no systematic study of the various soils used, but it is usually a clayey sand without gravel. The most durable soil types are to be found in lateritic areas. Stabilizers or additives intended to improve the soil, such as vegetable fibres and straw, are very rarely used in the composition of the walls, but are more readily added to renders.

One example of rural housing: the compound

In the Cameroon, Upper Volta, Ghana and so on, all the members of the same family live within a compound.

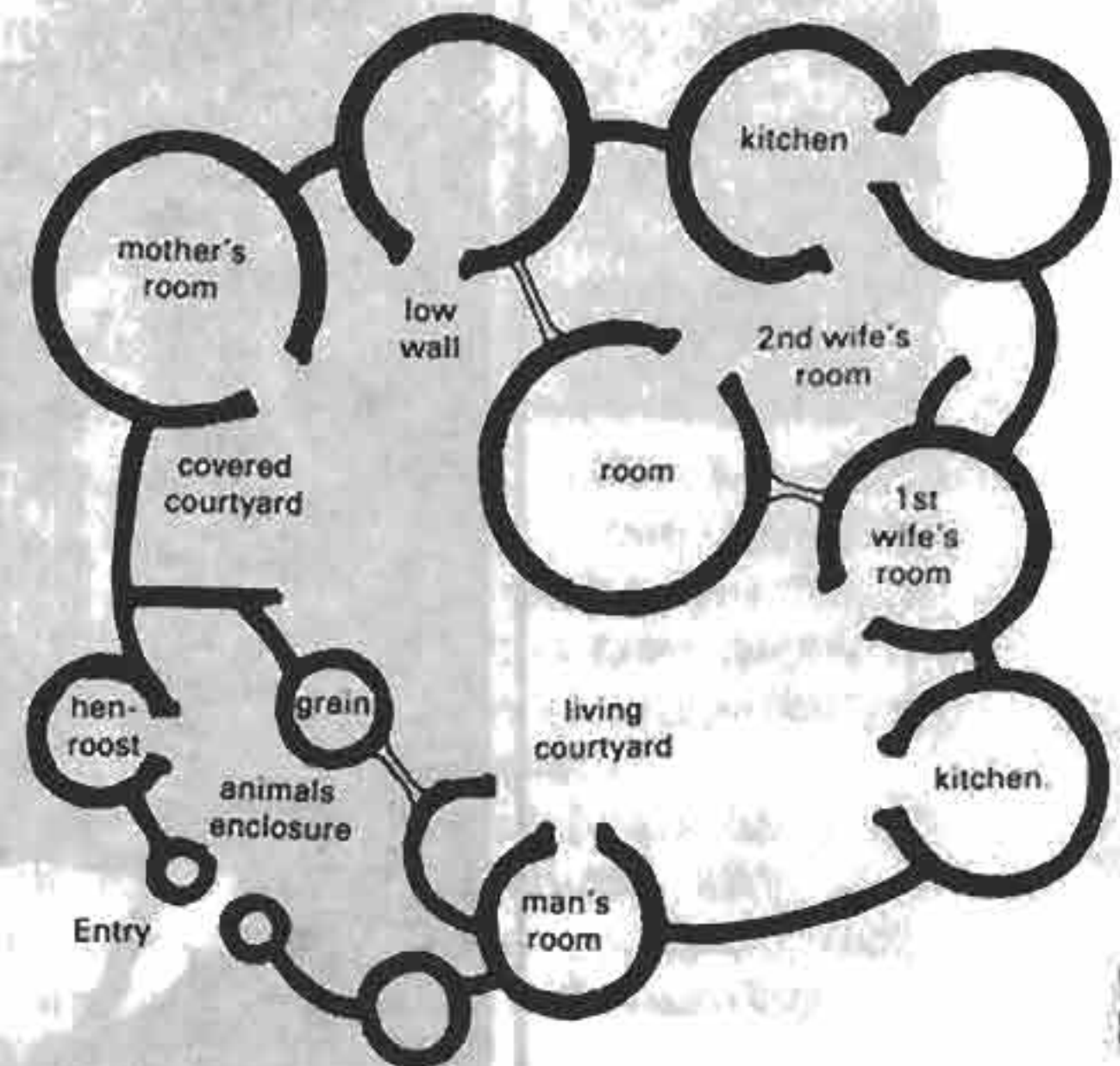

FIGURE 122: UPPER-VOLTA

The round buildings which make up the compound are linked by a perimeter wall thereby also creating an inner courtyard often with only one point of entry from outside; access to the houses can therefore only be gained

through the courtyard. Each building is independent and fulfills a specific and temporary purpose: the husband's room, the wife's, the grain-store etc.

FIGURE 123: EXAMPLE OF COMPOUND



The plan illustrated (fig. 123) shows a Nabdam compound in Nangadi in northern Ghana. The Nabdam people are sedentary farmers living in family groups. Each compound therefore shelters at least one man with his wife and children, but might also include the head of the family, his brothers and their families.

Around each family compound is a garden in which are grown tobacco, marrows, tomatoes and all the usual vegetables; within it a space - separated from the living areas by a low wall - is set aside for animals which are herded into it at night in case of outside dangers or social tensions.

The grain-store has both an important economic value and a symbolic dimension, appearing to be the pivot from which radiate all the various spaces. In small compounds it is located between the animals' enclosure and the living area. In an agricultural society where the survival of the community depends on correctly stocking grain, the grain-store becomes of fundamental importance. It is also a symbol of family unity: to have a separate store of grain is often a pretext for separation.

The layout of the compound is modified following any change in the family structure (marriages, departures..) and the system of building in independent units without any fixed shape lends itself admirably to all transformations. The buildings are small in size (maximum 10 m², and 2 or 3 m high).

The easy availability of the material enables new buildings to be put up quickly, either grouped around the main courtyard or forming a secondary courtyard.

The construction of a round house

Once excavated, the earth is piled up, moistened with a little water and mixed to a smooth plastic consistency (15 to 20% water). This mixing can be done by puddling with the feet, at the same time removing all unwanted roots, stones etc. This mixing process often takes half a day.

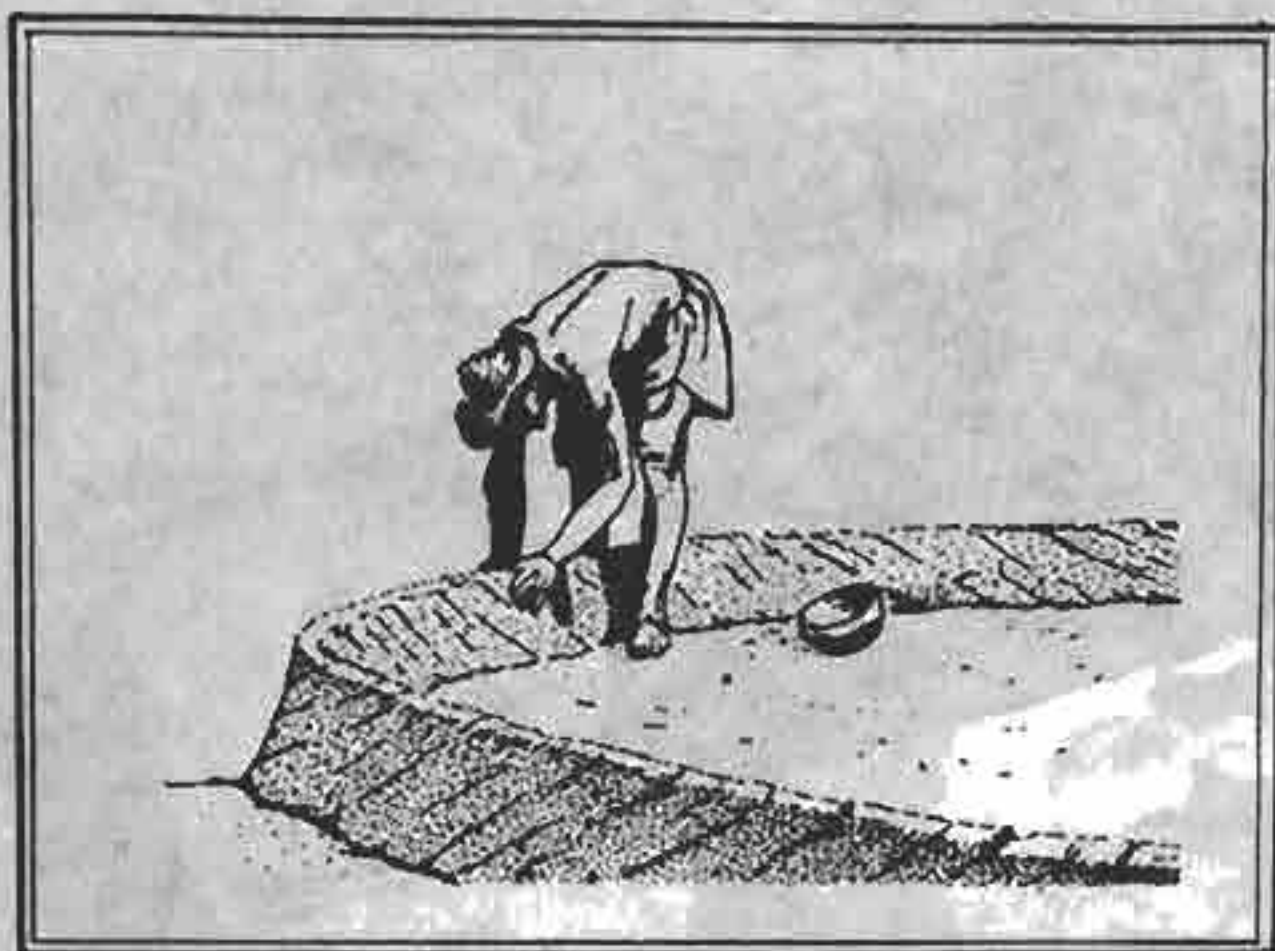

FIGURE 130: THE FIRST COURSE IS HAND-SHAPED BY THE MASON

The walls are thin (10 to 30 cm at the bottom and 5 to 15 cm at the top) and rest on a wider footing (30 cm high) which can double as a bench.

For grain-stores, the building starts from an earth floor reinforced with wood and placed on large stones or on piles driven into the ground, which provide protection from rain water during the rainy seasons.

Once the footing is complete and sufficiently dry, the mason starts on the walls. His assistants shape the mud mix into balls 15 to 20 cm in diameter and 3 to 4 kg in weight which they throw to the mason. Working backwards and sloping the joints between the balls to an angle of 45°, the latter presses them firmly one against another forming a ring around the wall. Several rings are completed in this way to a height of 50 to 70 cm. Once this course is completed the surfaces are finished off by smoothing them with a flat stone or a machete. They are then left to dry out for 2 or 3 days before the next course is started.

As the building gradually goes up the courses diminish in height. There being no scaffolding, the mason sits astride the dry part of the wall. Thanks to the fact that the walls are thin and the earth in a plastic state, the building goes up

FIGURE 131: COLLECTIVE BUILDING OF A ROUND HOUSE



ADAU

in a manner similar to coiled pottery i.e. simply by hand-moulding. Normally two assistants shape and carry the balls of earth to one mason. Several teams can work on the same course, in which case the work is rapidly completed and the drying out more homogeneous.

Once the walls are up a thatched or flat roof is laid. An earth mortar stabilized with plant extracts covers the interior courtyard walls, which are richly decorated with paintings and incrustations.



ADAU

FIGURE 132: COLLECTIVE BUILDING PROCESS

FIGURE 133: THE SURFACES OF THE WALL ARE SMOOTHED WITH A STONE



ADAU

FIGURE 134: GRAIN-STORES

FIGURE 124: GRAIN-STORES

Gilles Garby

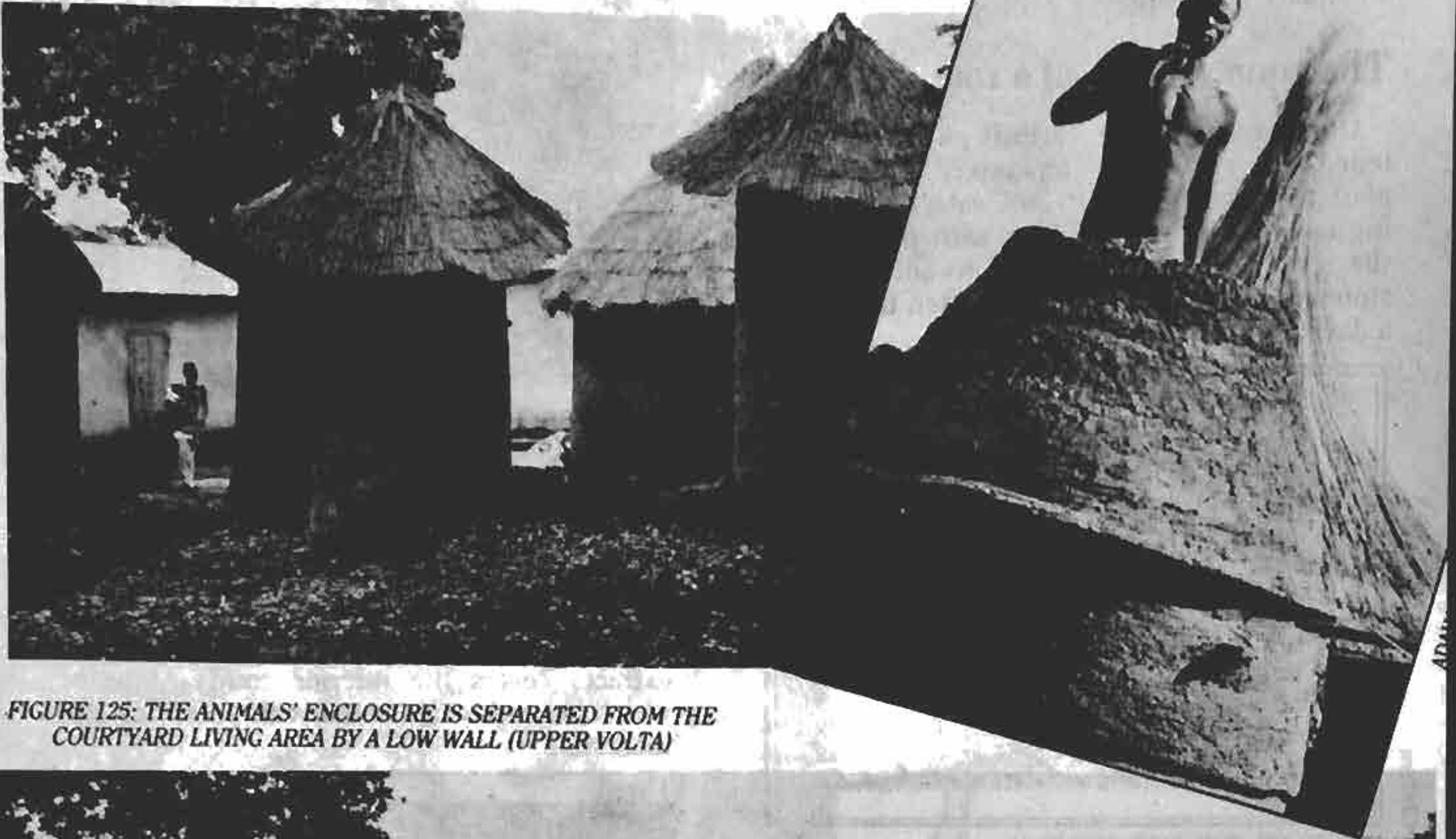
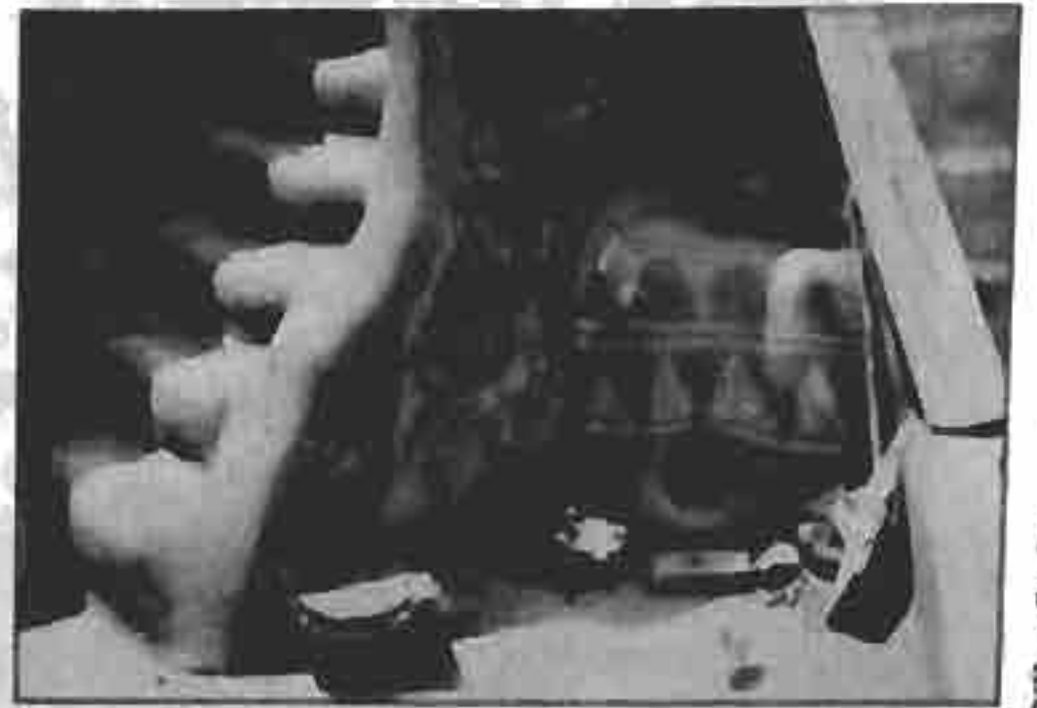

FIGURE 125: THE ANIMALS' ENCLOSURE IS SEPARATED FROM THE COURTYARD LIVING AREA BY A LOW WALL (UPPER VOLTA)





◀ FIGURE 126: UPPER VOLTA



Gilles Carby

▲ FIGURES 127/128:
CHICKEN COOPS ▼

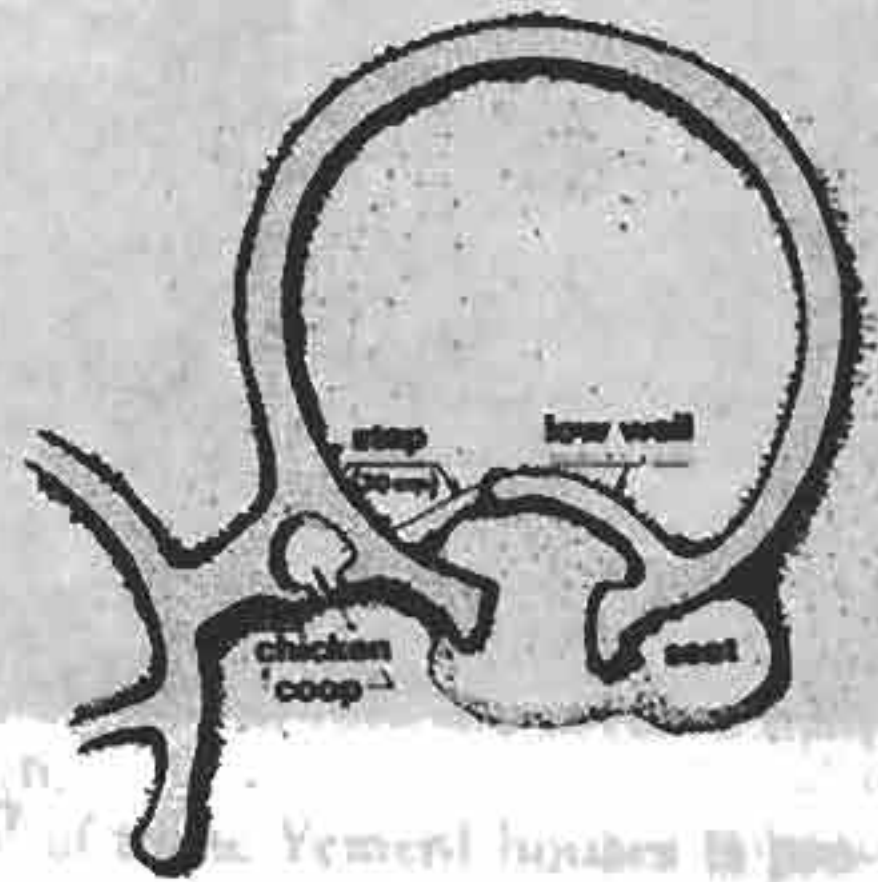

CRATerre

... of the Yemeni houses is the same way as an intermediate floor of a mix of mud and lime is used. It must be checked. **FIGURE 135: NIGER**





FIGURE 136: PARTIAL VIEW OF SA'DAH,
TO THE NORTH OF THE DESERT PLAINS

Max et Suzanne Hirschi

EARTH BUILDING IN NORTH YEMEN *

In the vast, semi-desert plains at the confines of the desert to the east and north-east of the country, earth is the basic building material. In these areas, as is the case virtually throughout the country, the houses stand tall and proud, some of them five storeys high. Yemeni masons using earth for building walls are familiar with two distinct techniques:

- The first is characterized by the use of a sod of unprocessed earth $19 \times 19 \times 8$ cm which is piled up in several layers to build the walls of the house, all of which are load-bearing in this type of architecture.

- The second technique used by Yemeni builders seems more original as it could be said to be unique to the earth architecture of the Yemen. The walls are built out of a kind of huge "sausage" of mud which is shaped all round the house on a previous layer (fig. 138). This operation is repeated as many times as is necessary,

leaving the minimum drying time needed between each layer, and enables the builders to realise walls without formwork which can reach nearly 18 m in height.

FIGURES 138/138A: MASONS SHAPING A HUGE MUD "SAUSAGE"
IN ITS FINAL POSITION



Max et Suzanne Hirschi

The majority of earth houses in the Yemen, and more particularly all the houses of the northern half of the desert plains, are built using this process which to a large extent defines their architectural character.

Thus from the front the different earth courses making up the wall can be clearly distinguished delineated one from the other by deeply indented joints. Also apparent at the ends of these horizontal bands are the four raised corners shaped like the prow of a ship, repeated right up to the top of the house, with its horned ridges. These raised corners of each course are achieved thanks to the presence at ground level, and only at the corners, of large partially buried blocks of stone which take the place of foundations. Given the scarcity of good stone and the dry climate in this part of the Yemen, it is in fact generally thought that foundations can be dispensed with; thus apart from at the four corners of the house the walls are generally built on the ground itself.

To build the courses which make up the wall a clayey soil, mixed with sand, straw or cereal husks and to which water has been added to achieve the right degree of plasticity, is used. The mixture is puddled with the feet and left to rest for two days to allow the straw to absorb water thus giving the material a smoother consistency. The resulting mixture is then thrown to the mason by his assistant in the form of moist semi-compacted lumps. The mason stands on the previous course of wall and shapes the

earth mix into the next layer (the "sausage"), beating it with his fists to create a homogeneous mass (figs. 138 and 138a).

A few hours after the new layer has been completed all around the perimeter of the house as well as on the internal walls, the mason stamps on it vigorously and smooths the external surface; after which he lets the now finished course dry out for approximately two days.

Where necessary openings are left for windows by the simple expedient of interrupting one or more courses, according to the height of window required. A lintel, usually consisting in a plank or a bundle of branches, is placed over the opening, so that the following course can be laid continuously again. In contrast small openings or loopholes are simply cut through the mud "sausage" before it is completely dry with a small pick.

The floors of the earth houses are built on a row of joists (acacia trunks) which rest on the interior walls at approximately 60 cm intervals; a layer of branches is placed at right angles on top of them, and these in turn are covered with compacted earth.

The flat roof of these Yemeni houses is produced in the same way as an intermediate floor but a "waterproof" mix of sand and lime is usually applied. It must be checked for damage after any heavy rain and if necessary repaired.

The stairway of the earth houses is usually square. It links one storey to the next in 3 or 4 flights of 3 to 5 steps about 30 cms high, each supported by a central pillar. The individual flights of steps are built in the same way as a sloping floor with joists and branches on which the earth is shaped into steps.

The plan of the earth houses is usually square or rectangular and varies according to the size of the house. The traditional four-flighted staircase giving access to the upper storeys is located in one corner.

As a general rule, only a few small openings are to be found on the lower storeys of the facade of Yemeni houses, whereas the uppermost floor contains a row of larger windows, often surmounted by semi-circular stained-glass openings.

Also noteworthy is the white plaster (goss) used to highlight and frame certain parts of the earth facade.

This decorative render, together with the window surmounted by a semi-circular opening, are very characteristic of Yemeni architecture. They are, however, also to be found in more elaborate form on the brick and stone facades of

IN ITS FINAL POSITION ...

drawn from a Alain St - Hilaire's photograph



the upper and intermediate plateaus of North Yemen.

The house illustrated in figures 139 and 139a is built in the north of the country in Sa'dah, a town with a population of 4,350 and in which all the houses are built according to the technique described. This particular two-storey, fairly modest, house belongs to a craftsman who repairs and sells "djambias" (the traditional Yemeni dagger). He lives on the upper floor while his wife and three children inhabit the ground floor. The first floor bedroom, as well as that of the wife and children, are white-washed and have alcoves let into the walls. The remaining interior walls of the house are covered with a mud plaster.

On the whole this house is clean and well cared for. The front windows are sufficiently large to allow good ventilation and enough natural light for the various rooms. Light for the staircase comes through loopholes in the facade.

* From "L'architecture traditionnelle au Yémen du Nord", Suzanne and Max Hirschi, Berger-Levrault Publishers.



Max et Suzanne Hirschi

FIGURES 139/139A: HOUSE AT SA'HAH WITH FEATURES VERY TYPICAL OF YEMENI ARCHITECTURE

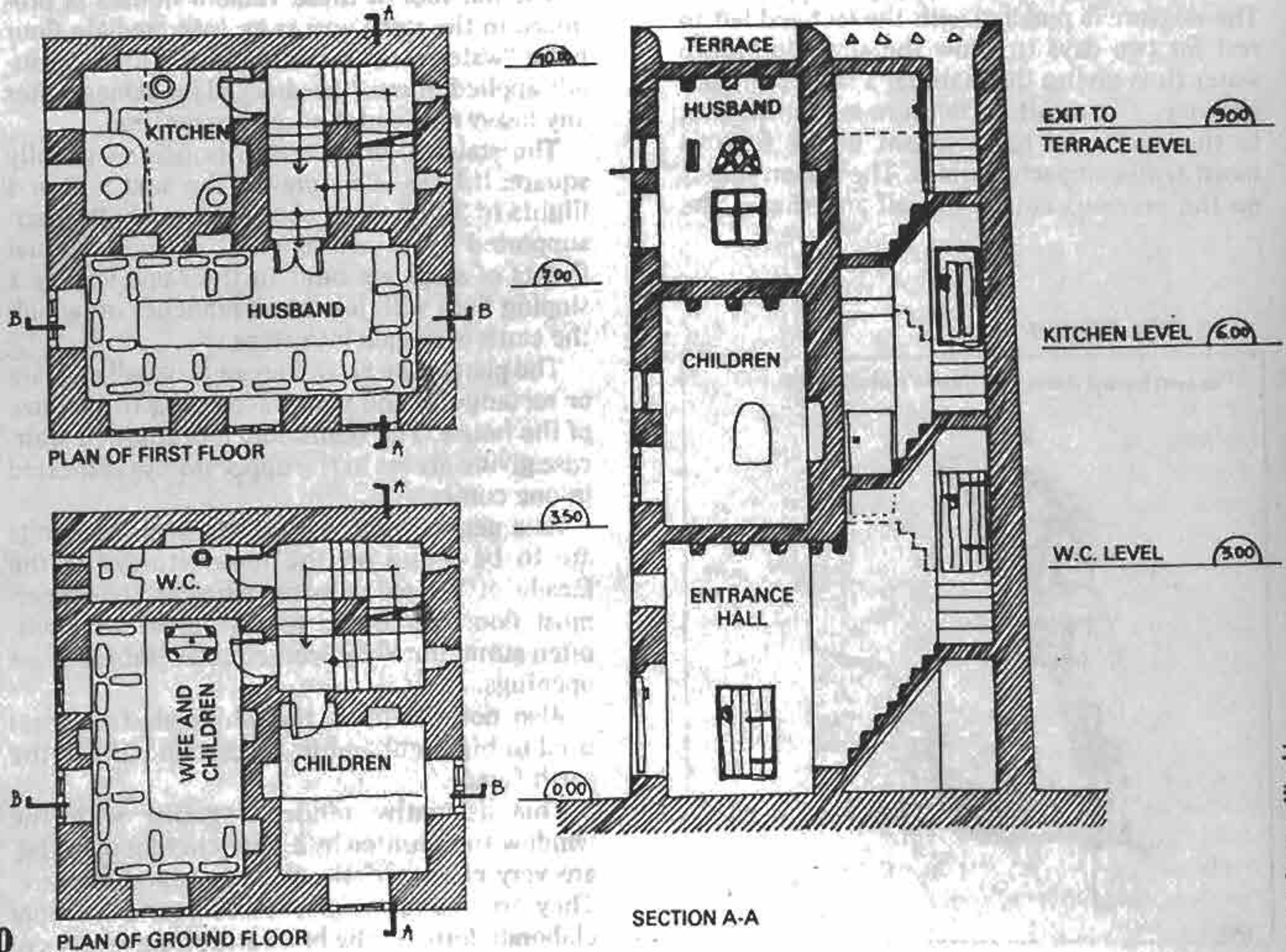



CNRATerre

FIGURE 142: COB HOUSE (SCOTLAND)

EUROPE

In France, this technique is known as "bauge". It is also found in numerous other European countries, even in areas notorious for their wet climate (Cornwall, Dorset, and Devon in England, and Scotland...) this type of housing easily stands up to cold and windy winters.

In Devon (England) and Scotland, entire villages built of one or two-storey "cob" cottages are to be found. This cannot therefore be dismissed as a minor building technique even though in France its name is often associated with small agricultural buildings, such as pig sties, sheds etc., (in French, "bauges a cochons" and "remises en bauge" respectively.)

The best known example of cob construction in France is undoubtedly the so-called "Bourrine" of the Vendée region.

The material used

a) **Earth:** A moderately heavy sandy soil is the best material for cob building since earth too rich in clay would be much more difficult to work with and would take much longer to dry out.

The particle size analysis of earth samples taken from houses in Devon (England) gave the following results: sand 33%; clay 21%; (straw 1.6%).

These proportions correspond to those most frequently used for rammed earth construction in France. In England cob houses are sometimes found alongside rammed earth ones. But the latter are rare as it is difficult to find soil sufficiently dry to allow good compaction.

b) **Fibres:** Vegetable fibres are nearly always added to the soil - straw, heather, wheat chaff etc. - and these fulfill several functions.

In the first place they increase the tensile strength and hence the flexibility of the material. Ordinary earth in contrast can resist only limited pressure, whereas reinforced soil can be subjected to substantial deformation without cracking. This elasticity prevents the wall from developing cracks during drying out, as the fibres spread the load generated by clay shrinkage throughout the material. In the second place, the volume they occupy in the wall diminishes its density and improves its properties of thermal insulation.

The usual proportion of fibre is in the order of 25 kg per m³ of earth (1.6%). Measured in **101**

weight this may seem a small proportion, but in volume terms it represents approximately 250 litres of fibre for every 1000 litres of soil.

Straw is chopped into pieces measuring 15 to 40 cm before being mixed into the soil.

Application

The excavated earth is spread out in a layer 20 cm deep. Unwanted material is removed with a 4 or 5 prong rake, and the larger sods are broken up. Water is then added until the earth acquires the consistency of a thick mortar (approximately 20% water).

Circular mounds 1.3 m in diameter are then prepared all around the house, beginning with a 10 cm layer of earth. A builder stands on top of the mound, spreads the straw and treads it forcefully into the earth. Once the straw has been well mixed in, more earth is added, followed by more straw, and so on until the mound is 1 m high. If necessary, the straw will be sprinkled with water between each layer. Before using the mix it is left to rest for one day.

The earth can also be prepared by spreading it over a wide area in a single layer and using animals to tread it.

The foundation consists in a heavy footing of stone or brick covered with a material which is resistant to humidity. Standing on one of the mounds of earth, one of the builders passes the mixture to the mason on a fork. The latter spreads it on the wall, heeling it firmly in. The resulting earth mass should overlap the sides of the footing by 5 to 10 cm to allow for trimming once the wall is finished. The first course of 0.6 to 1 m high is built up in this way (fig. 144).

After five days' drying out, wooden planks are placed on top of the wall, their external edges marking the edges of the wall. Standing on top of the planks the mason uses a special pointed spade to cut vertically into the cob using the planks as a guide, thus trimming the wall.

His assistant uses a sort of rake to punch slanting holes 7 cm apart and 2 cm deep in all the freshly exposed surfaces. These will enable the render to adhere. For the same reason all the smoothly trimmed surfaces are sometimes dotted with small fragments of brick stuck into the cob and projecting by 1 cm.

After 1 or 2 weeks' drying out the next course is built up and worked in the same way.

At all vulnerable points where cracks might appear (at the corners of windows and doors), wooden sticks coated with mud are placed in the width of the wall.

Cob takes quite long time to dry out and in rainy weather it is sometime coated with mud are placed in the width of the wall.

Cob takes quite long time to dry out and in rainy weather it is sometimes necessary to wait 3 weeks between each course. Thus although the working time is fairly short, since 4 men can build 15 m² of wall 60 cm thick in a day, the complete construction of a house is a lengthy process. As drying out is impossible in the winter, work begins at the beginning of the spring in order to be able to lay the roof before the winter. Currently no artificial drying methods exist except lighting a good fire inside, but even so it will be several months after its completion before the house is habitable.

The houses tend to be single storey, which speeds up the building process. The walls are approximately 45 cm thick and can go up to 80 cm for 2 or 3 storey houses.

A cob house requires excellent protection from humidity: with "a good hat and a good pair of boots" a building can last for several centuries. To avoid water leaking from the roof, some additional protection (roofing felt, tiles etc.) generally covers the upper layer of wall. Renders are indispensable in this type of building. Finally each window has projecting ledges to prevent rain from running down the wall (fig. 145).

FIGURE 145: COB HOUSE, DEVON (ENGLAND)



A



A: PREPARING THE MIX: EARTH AND STRAW

B

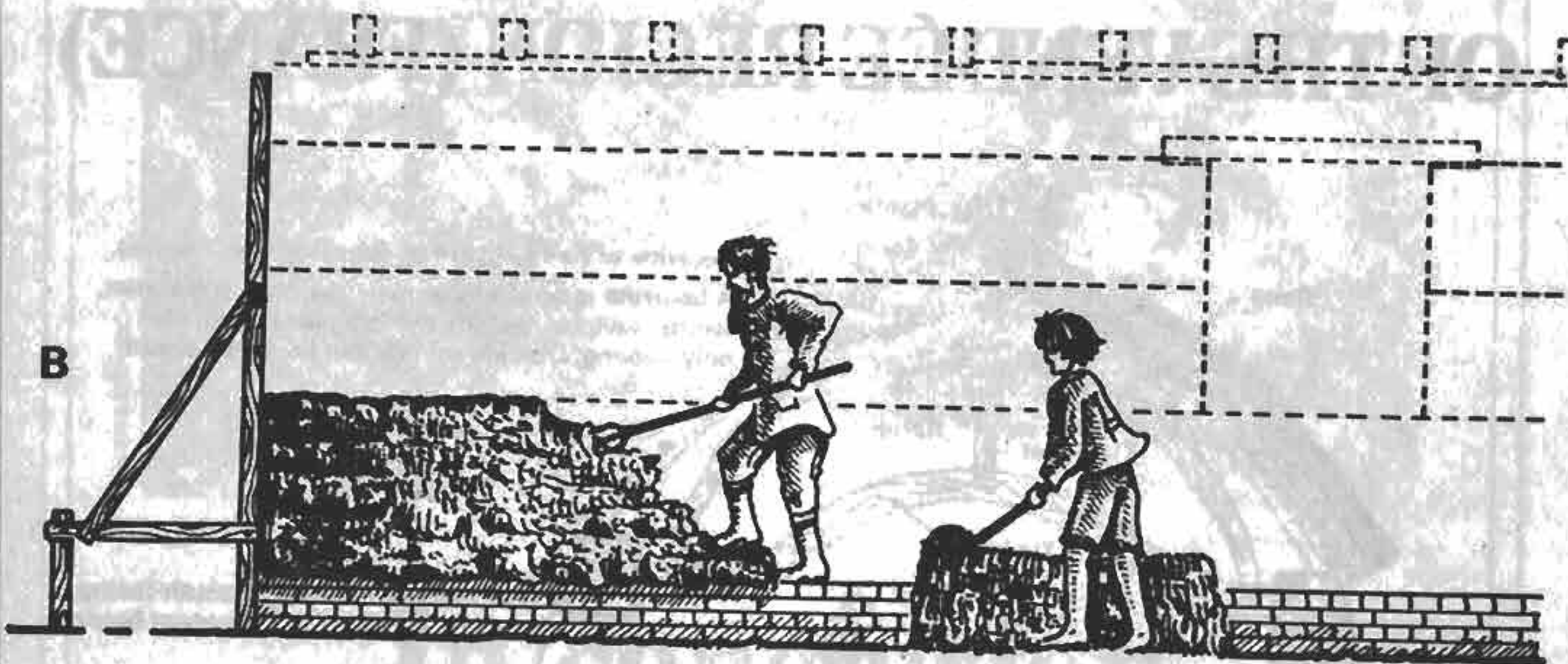

B: BUILDING THE WALL

C: TRIMMING THE WALL WITH A POINTED SPADE AND PREPARING THE SURFACES FOR RENDERING

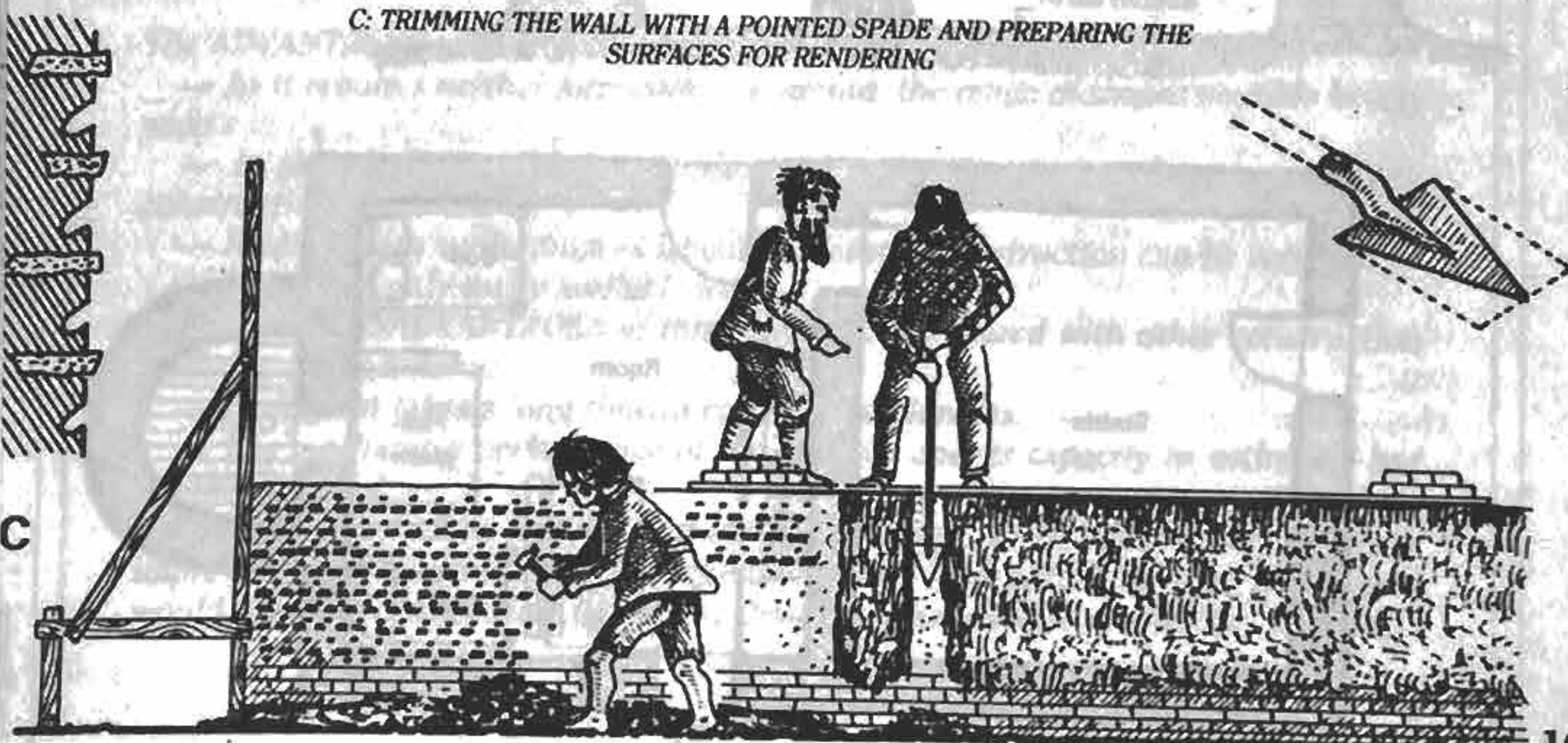

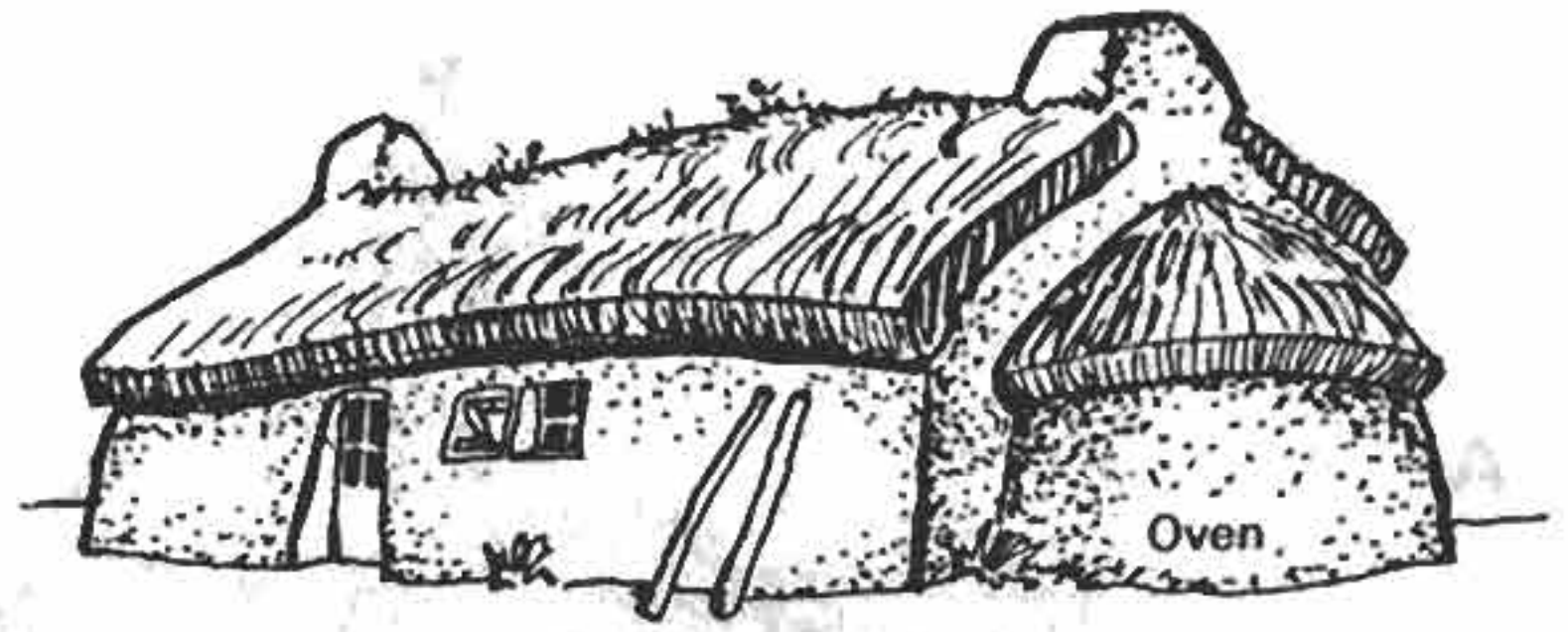

BOURRINE AT SAINT-HILAIRE DE-RIEZ (Vendée, France).

THE "BOURRINE" OF THE VENDÉE REGION (FRANCE)

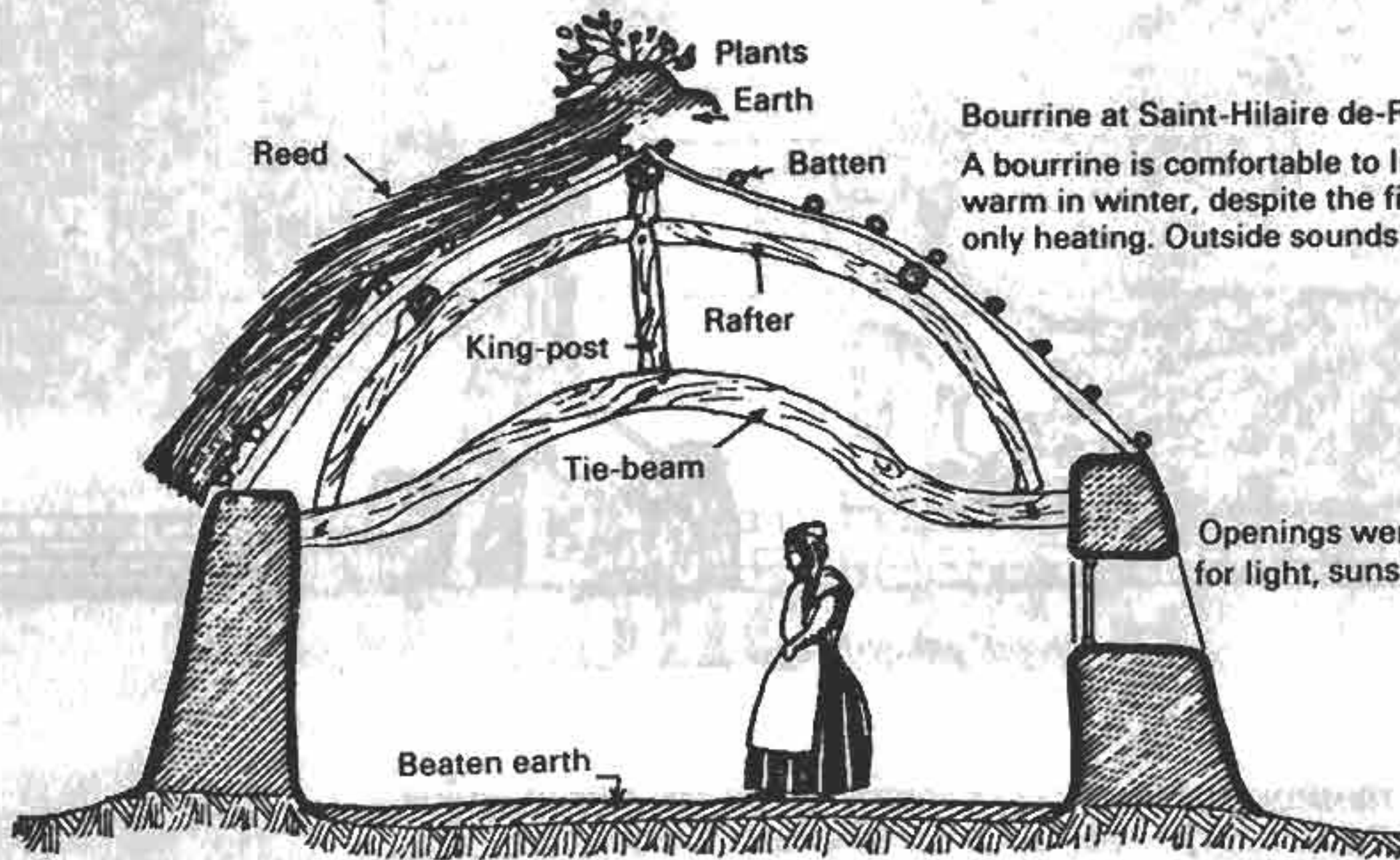

Bourrine at Saint-Hilaire de-Riez (Vendee, France).
A bourrine is comfortable to live in, cool in summer, warm in winter, despite the fire-place being the only heating. Outside sounds can barely be heard.

Openings were general south-facing for light, sunshine and pleasant breeze.

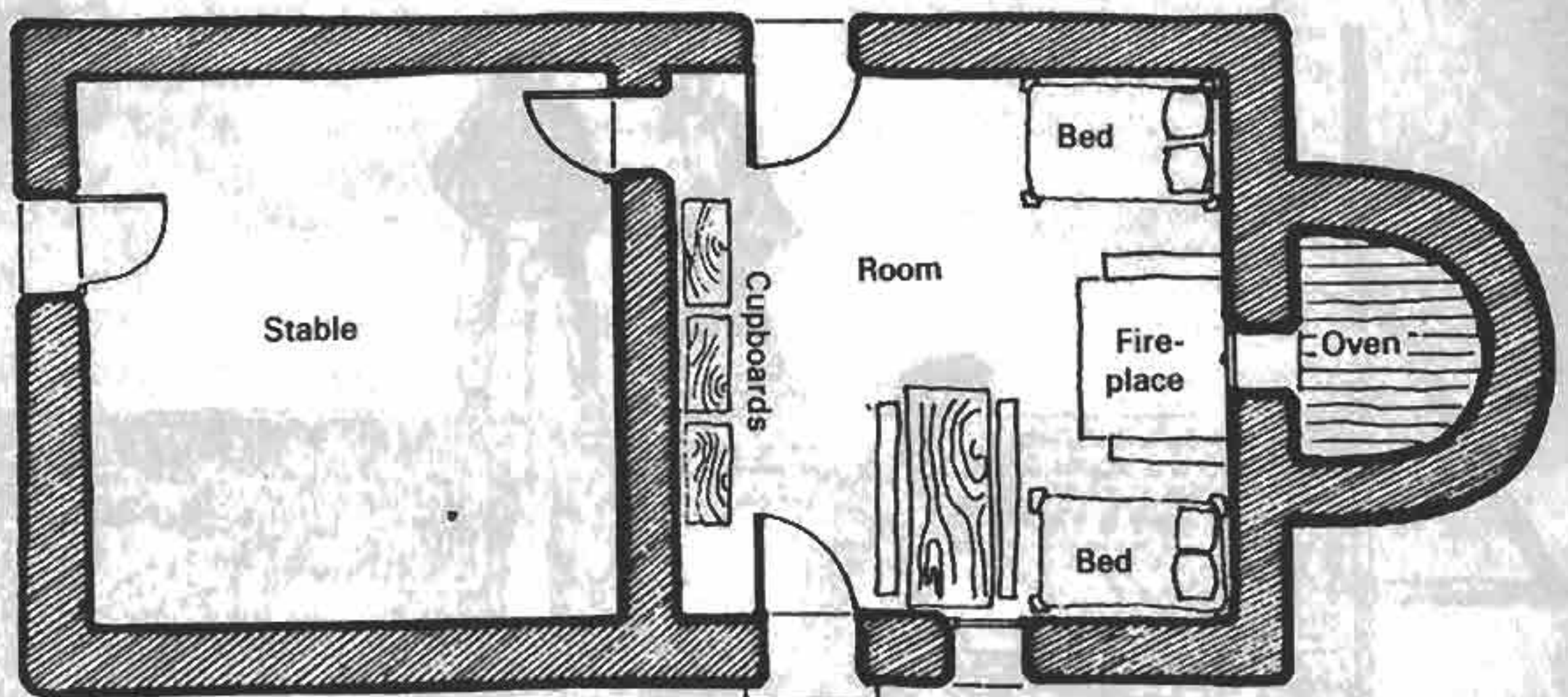



Jacques Debiesse

In conclusion

The ADVANTAGES of this type of construction can be summarized as follows:

- *As it requires neither formwork, nor mould, the range of shapes possible is very wide.*
- *It provides an excellent solution if the soil is too wet for rammed earth construction.*
- *Realised with a minimum of labour, the cost of construction can be very low.*
- *It requires only easily available tools.*

The main DISADVANTAGES of this technique, compared with other construction methods, are as follows:

- *Drying out takes a long time in cold, humid climates.*
- *The mechanical performance of the material and its capacity to withstand bad weather are poor.*

Finally, unlike adobe and rammed earth, cob has yet to be studied with a view to improving its characteristics. Recent stabilization and mechanization techniques would probably considerably reduce the disadvantages associated with this material.

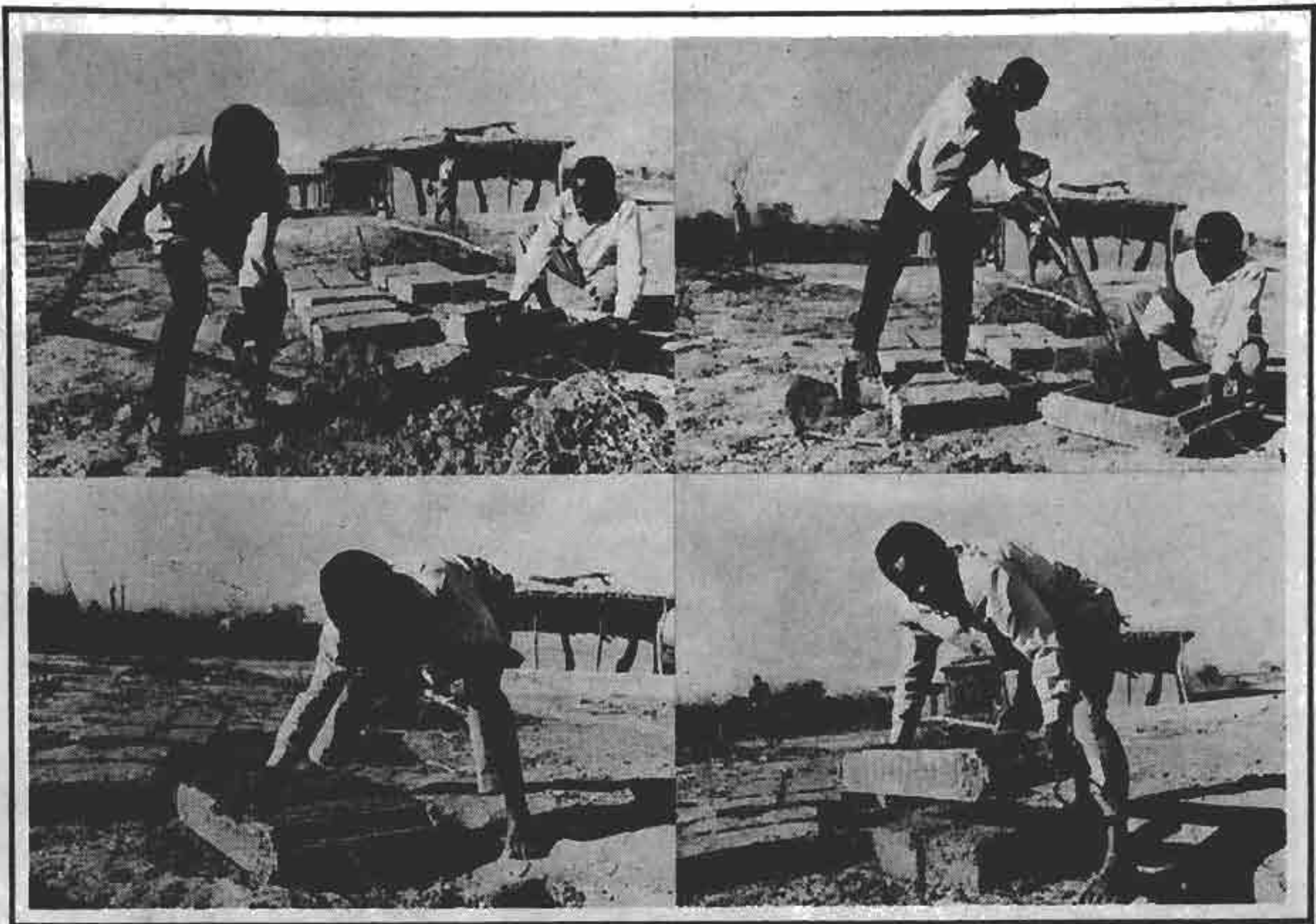

Jacques Debiesse

FIGURE 146: TANZANIA

3. ADOBE

Adobe is a technique which consists in making mud bricks using moulds but without compaction and letting them dry in the sun.

Adobe bricks have been used for thousands of years and are probably one of the first man-made construction materials. The term "adobe" derives from the Egyptian "thobe" meaning brick; this gave rise to the Arabic term "ottob", corrupted into "adobe" in Spanish, and "toub" in French. It is also known as sun-dried mud brick and "banco". Adobe bricks do not necessarily have to be parallelepipeds, but exist in many shapes, conical, cylindrical, trapezoidal etc. These particular shapes take their place in historical terms somewhere between the direct moulding of balls of earth and the appearance of the rectangular mould. "The first attempts to make mud bricks were probably lumps of clay roughly shaped, dried in the open and hardened by the sun."

The archaeologist José Imbelloni suggests the following evolution: bricks were originally conical, then half-spherical cylindrical cones, then indented and finally parallelepipeds (fig 147). The shape of the adobe brick thus evolved through trial and error over the centuries.

FIGURE 147: VARIOUS SHAPES OF NON-PARALLELEPIPED BRICK

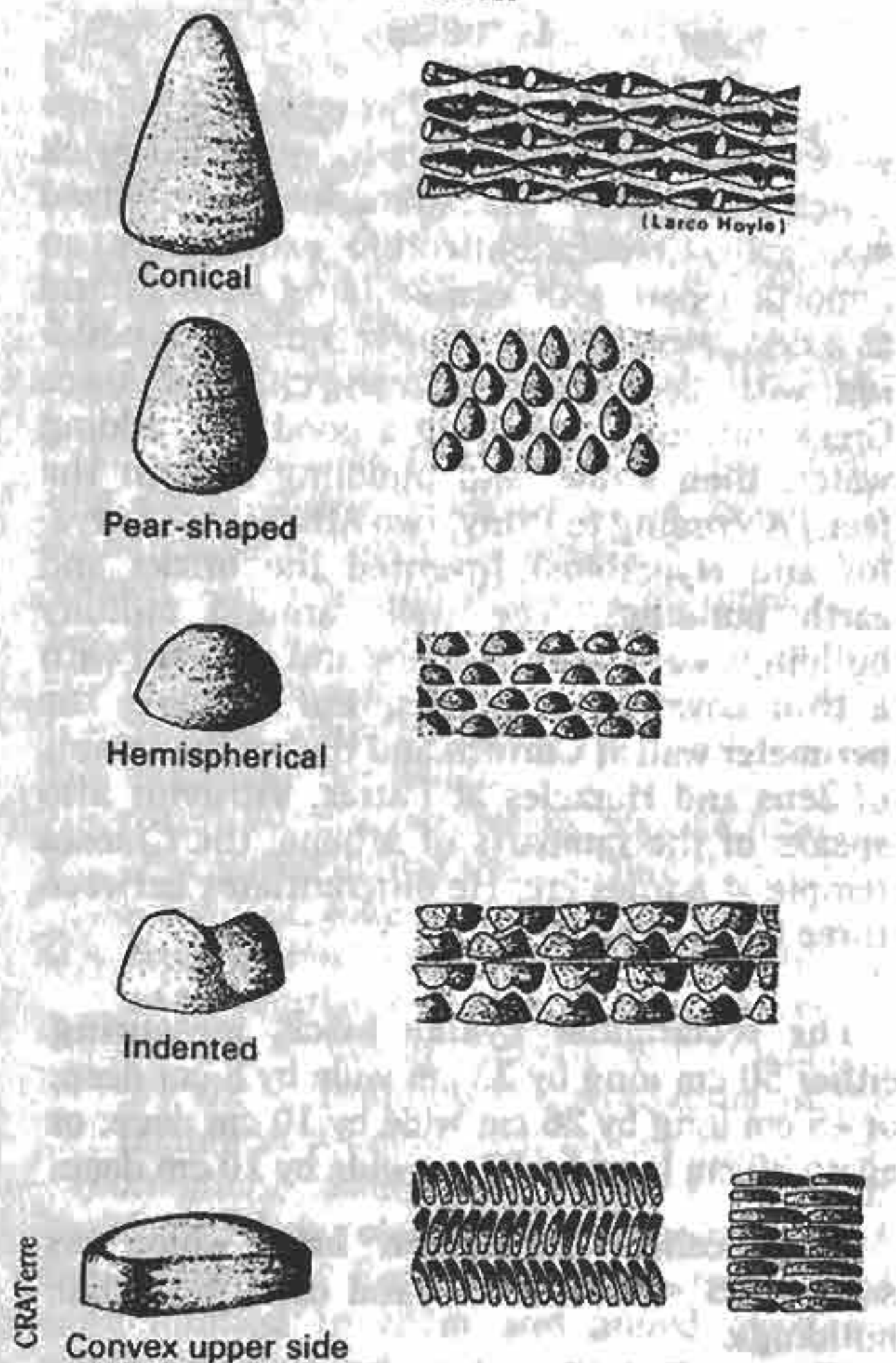

The conical shape for example can be found in Peru dating from the Cupisnic period (1000 B.C.) and was used to build the pyramid at Moxeque with its eight levels and a square base measuring 165 x 170 m

Larco Hoyle suggests one possible bonding pattern according to which the bricks are laid with pointed ends alternately facing each other (fig. 147).

The pear-shaped brick, common in West Africa, has been used for building housing for over 5000 years. It is currently found in Togo, and in northern Nigeria: Zaria (fig. 148). Known as "tubali", these bricks are made without moulds using a mix of earth and straw. For walls they are laid two or three bricks deep. For the first course the tubalis are laid with the wider end downwards, the following course is laid "head to foot" and so on.

FIGURE 148: PEAR-SHAPED BRICKS (NIGERIA)

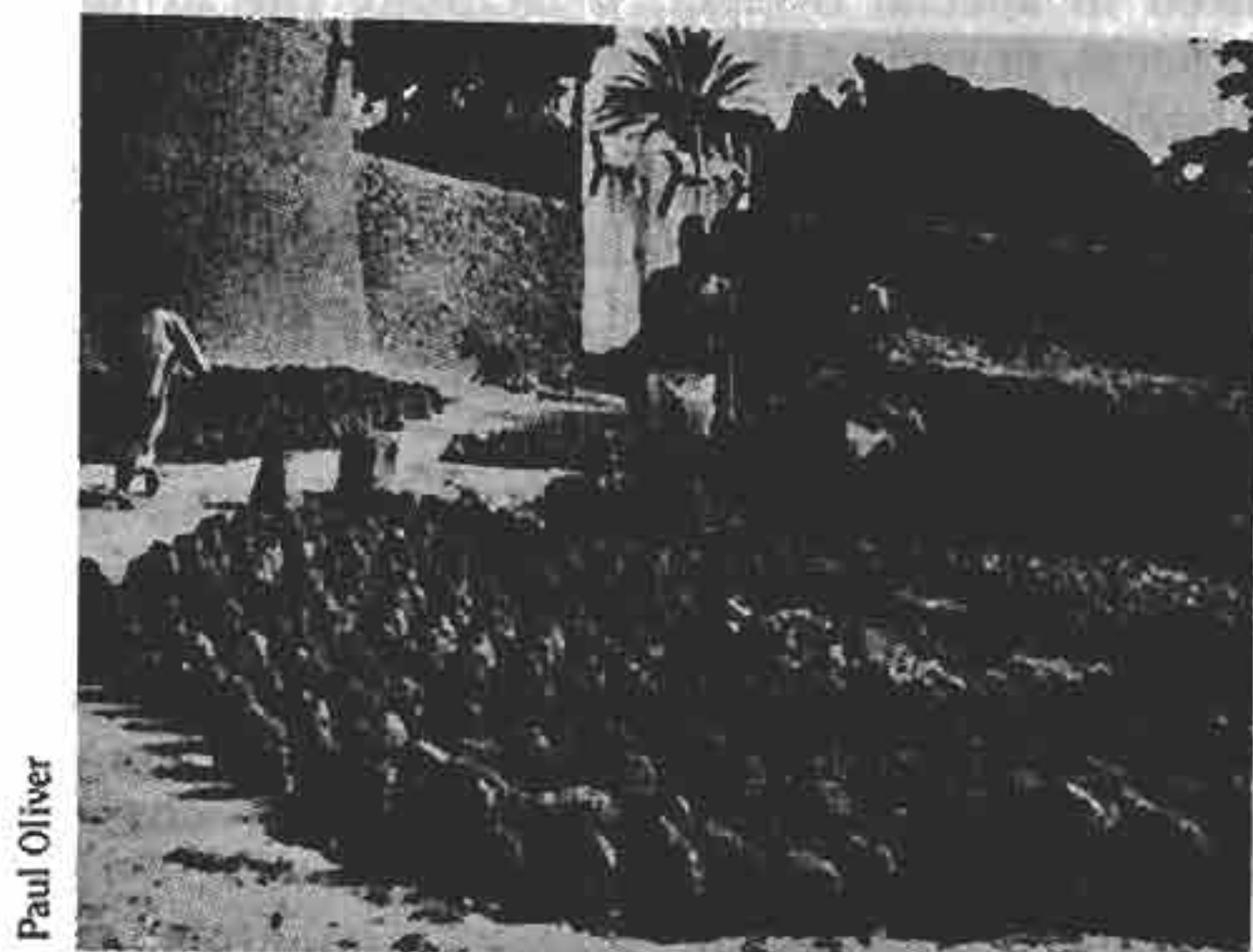

Paul Oliver

I - MAKING ADOBE BRICKS

Before considering the technical problems of making adobe bricks, the historical context in which they have been used amongst different civilizations for thousands of years is of interest.

BRICK PRODUCTION IN ANCIENT TIMES

We learn from a document found in the "Dictionnaire de la Bible" (Dictionary of the Bible) by Vigouroux (1912) that using adobe was faster and easier than using stone. One

advantage was that it used cheap labour (prisoners of war).

Babylon

The raw material was readily available, often at the construction site itself; it only remained therefore to break up the soil and add a certain amount of water. This mix was puddled with the feet in large shallow basins. For sun-dried bricks, straw chopped into small pieces was added to the wet earth to give it more consistency.

Once puddled, the clay was pushed into moulds of approximately square shape which produced large bricks. These measured 20 to 40 cm in length by 5 to 10 cm wide, the most common length being 315 mm, and were therefore larger in size than the Egyptian brick.

For the most part they were simply left in the sun where they quickly dried, especially in the torrid heat of the summer months. The first month of the summer season, the month of SIVAN, was called "the month of the brick".

Sometimes they were used barely dry so that when placed one on top of the other they finally fused into a single compact mass, in which only the different shades of the courses betrayed the use of bricks. Mud bricks dried in the hot sun of these climates become extremely hard, but cannot withstand prolonged exposure to water. In order to improve their resistance, some were fired in special ovens. To facilitate the firing process, ensuring that the brick dried out completely and hardened without calcifying, it was made smaller than the sun-dried brick. Its colour was different: instead of the whitish or pale yellow shade of the sun-dried brick, it tended to be more of a dull red colour. Both bore the mark of the reigning prince in one corner: a kind of seal was used to imprint his names and titles on one side while the brick was still soft...

Both kinds of brick were used for construction work, but more frequently in Babylon than in Nineveh, (foundations and wall coverings/wet ground/torrential rains).

The common people had access only to sun-dried bricks ... In Assyria, they often made do with wetting the bricks before laying to bond them together, and this together with the load they bore, was sufficient for them to adhere.

In Chaldea on the other hand various mortars were used: a simple clay mortar for the interior of houses or crudely-built walls, or a very effective lime-based cement for larger edifices (at Birs-Nimroud) or again a mix of fly ash and lime (at Mugheir) where it is still used and known as "charour". Bitumen, a natural cement characteristic of Chaldea, gave the most durable results however. Moreover, layers of reeds placed at regular intervals helped to maintain greater solidity and cohesion between different courses of bricks. This method has been observed in a number of ruins and Herodotus

108 had noted it in Babylon as follows:

"As the ditches were being dug, the earth extracted was transformed into bricks and when there was a sufficient quantity they were fired in the ovens. Hot bitumen was then used as a mortar and every thirty courses a layer of interwoven reeds was added."

Greece

In Greece, public as well as private buildings were at various times built in sun-dried brick which represented "the hallmark of the civilized man". In Greek architecture earth plays an important part both as a building element and as a decorative feature. The technique of building with adobe has scarcely changed since Greek antiquity (choosing a good soil, adding water, then straw, and puddling it with the feet.) According to Pliny, two Athenians (Euryalos and Hyperbios) invented the bricks and earth buildings. The walls around military buildings were built in adobe and finished with a thin covering of stones. For example the perimeter wall at Corinth and that of the temple of Zeus and Heracles at Patras. Vitruvius also speaks of the ramparts of Athens, the Creoses temple at Sardes etc. He differentiates between three types of brick:

The rectangular Lydian brick, measuring either 50 cm long by 33 cm wide by 8 cm deep; or 45 cm long by 26 cm wide by 10 cm deep; or again 39 cm long by 19 cm wide by 10 cm deep.

The so-called "Pentadoron" brick, which was square (45 × 45 × 8 cm) and used for public buildings.

The so-called "Tetradoron" brick, also square (30 × 30 × 10 cm) and used for private buildings.

For each of these there was also a half-brick mould. The depth of the square bricks favoured by the Greeks was more or less constant: 8 to 10 cm.

Egypt

We know from Egyptian bas-reliefs that the sun-dried brick was in common use. Many scenes depicting the daily life of the fellahs (or peasants) as well as that of the Pharaoh and his court are to be found on the walls of tombs. For example, the bas-relief (fig 149) in which Queen Hatchepsout (1490-1469 B.C.) is portrayed preparing an adobe brick shows that the mould used was scarcely any different to the one used today.

FIGURE 150: SCENE ON THE TOMB OF REKMARA DEPICTING SLAVES USING MOULDS TO MAKE BRICKS



Vigouroux

On the Rekmara tomb at Gournah (fig. 150), one scene shows prisoners using moulds to make bricks to build the temple of Ammon at Thebes. The following stages are depicted:

- A - digging the earth
- B - transporting it
- C - drawing water to wet it
- D - moulding the bricks
- E - removing the moulds in regular lines
- F - after initial drying transporting them using a kind of yoke
- G - placing them one on top of the other in small regular columns slightly spaced in order to let the air circulate round them and dry them. Building the store-room of the temple of Ammon with stones and bricks.

Foreigners, easily distinguished by their beards and their colouring, can be seen amongst the red-painted Egyptians; the hardest tasks were allotted to them and armed overseers watch over them all.

The Bible (Exodus) tells of the use of straw in brick production:

“King Pharaoh gave orders: ‘Do not give them any more straw to make bricks with, as your custom has been; let them go and find straw for themselves. Meanwhile, you must give them the same tale of bricks to make as before; there must be no lessening of it. They are idle; that is what has led to this outcry about going and offering sacrifice to their God.’

So overseer and foreman gave it out to the people as a message from Pharaoh, ‘You shall have no more straw from me; go and gather it for yourselves where you can find it; meanwhile there is to be no lessening of the work done.’ And the people found themselves scattered all over Egypt gathering straw.”

Many more passages could be cited: Samuel

12, v.31; Judith 5, v.11; Isaiah 9, v.9; Nahum 3, v.14 ...

But straw was not universally used: the walls of Pothom are built in wide sun-dried bricks (44 × 24 × 12 cm) some of which have added straw or reed fragments, others only silt.

In the course of a visit to Luxor in 1978, we

FIGURE 149: QUEEN HATCHEPSOUT (1490-1469 B.C.) USING A MOULD TO MAKE AN EARTH BRICK

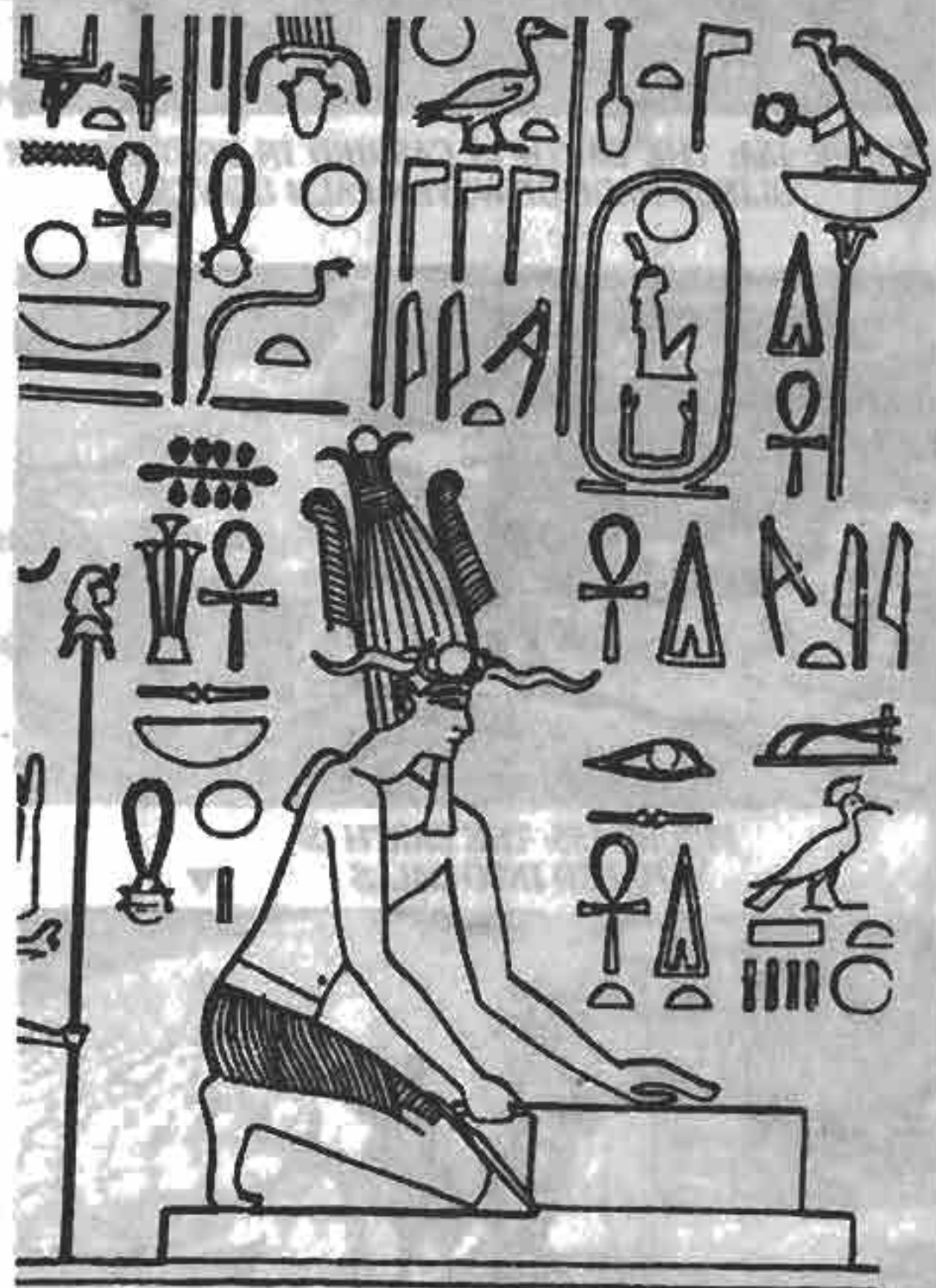

Hassan Fathy

observed that builders were making sun-dried earth bricks in exactly the same way as that depicted in the frescoes of the time of the Pha-

raohs. (Vigouroux also remarked on this in a letter from Samanoud dated 18th March 1894.)

A week before the start of production, the soil is ploughed and flooded. Chopped straw is spread and trampled into the soil. This absorbs water and swells the earth.

A labourer brings water to puddle the mix, from which the larger sods have been removed, to achieve a soft pasty consistency. A certain amount of this mud is placed in rectangular slings made from woven palm leaves and covered over with chopped straw. Each man carries two slings, one in each hand. By letting one of the handles slip, he allows the whole load to fall to the ground, leaving the basket empty.

The rectangular mould is placed on a smooth surface. It consists in 4 small hardwood planks, one which extends to form a handle.

The labourer takes a lump of wet earth, rolls it in the straw, shapes it and slams it down into the mould (so-called "ball" moulding). He then evens out the surface and lifts off the mould, leaving the brick he has just made on the ground. The next brick is made alongside the first and he continues to work in neat rows. The bricks dry in the sun and are then ready for use. They are fired in an oven if greater resistance is needed. An experienced worker takes 2 minutes to make 10 bricks and in 1978 bricks of this type were worth 23 French francs per 1000.

FIGURE 153: OVERALL VIEW OF PRODUCTION SITE OPPOSITE LUXOR - AN IRRIGATION CHANNEL BRINGS NILE WATER. THE SEPARATE AREAS FOR PREPARING THE EARTH, FILLING THE MOULDS, DRYING AND STOCKING THE BRICKS CAN BE CLEARLY DISTINGUISHED.



FIGURE 154: THE EARTH IS CARRIED IN RECTANGULAR SLINGS MADE OF WOVEN PALM LEAVES.



FIGURE 155: THE EARTH IS SHAPED INTO BALLS



FIGURE 156: THE BALL IS WET BEFORE BEING THROWN INTO THE MOULD.

FIGURE 157: THE EARTH IS EVENLY SPREAD BY HAND.



FIGURE 158: THE MOULD IS REMOVED AND THE PROCESS IS REPEATED.



SOIL SELECTION

It is easier to excavate the soil from a pit where there are no large stones, roots or top soil. Soils made up of sand, silt and clay in the following proportions are best suited to making adobe:

Sand: 55 to 75%

Silt: 10 to 28%

Clay: 15 to 18%

Organic matter: less than 3%

If the soil is stabilized with bitumen, the alkaline salt content should not exceed 0.2% as in the long term this would cause the bricks to split into scaly layers (cf. stabilization, ref. 51.)

Several possibilities can arise:

There is too much clay: cracks will appear in the bricks during drying. This is due to the volumetric instability of clay when exposed to water which makes them vulnerable to erosion.

There is too much sand: the particles are too numerous to all adhere together sufficiently. There will be inadequate cohesion and the bricks will crumble.

There is too much organic matter: as this decomposes it causes the characteristics of the material to change over time, and makes it porous and of poor durability when exposed to water. These proportions can be established in a laboratory or assessed on site thanks to simple tests.

A quick way to test if the earth is suitable for adobe production (fig. 160) consists in rolling in the palm of the hand a "sausage" of earth in a plastic state (it should not stick to the hands). It is carefully flattened between the fingers to form as long a "ribbon" as possible. The length of the ribbon is measured from the point where it breaks.

- If it breaks at between 5 and 15 cm long, the earth is suitable for adobe.
If it breaks at less than 5 cm, clay must be added.
- If it breaks at more than 15 cm, sand must be added.

The various stages of adobe production are reviewed below as is the way in which problems were overcome in the context of manual or semi-industrialized production (use of machine moulds such as the "Adobe-master".)

FIGURE 160: TO TEST THE SUITABILITY OF EARTH FOR ADOBE PRODUCTION

- Roll out some earth into a cigar-shape

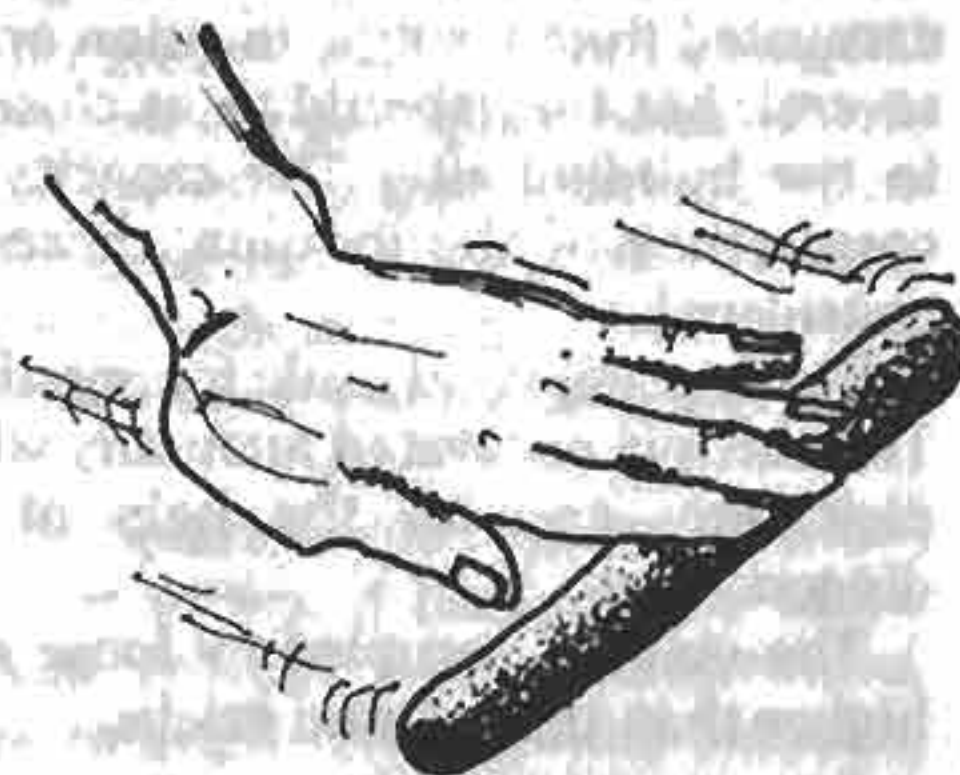

- Make as long a ribbon as possible

- If it breaks:



between 5 and 15 cm

good earth



at less than 5 cm

too much sand



at more than 15 cm

too much clay



Excavation

Earth suitable for adobe production can be excavated from a single location or mixed from several, but they should be as close as possible to the building site. The capacity, depth and consistency of the location chosen should be considered.

The top soil is set aside for possible later use. The earth is excavated manually with a shovel, pick, etc. or with the help of mechanical diggers.

The volume occupied by loose earth is 30% higher than that of mud bricks.

Sieving

Sieves with mesh diameters of 6 to 12 mm should be used, the finest being for stabilized brick production. Sieving is normally done at the point of excavation (the wheelbarrow can be placed directly beneath the sieve to avoid double-handling).

One man can sieve 4 m³ of earth per day.

Preparing the earth

The object of traditional preparatory hydration, or soaking, is to saturate the clay particles with water and break down all the small clods of earth. For adobe production the soaked earth is allowed to rest for 24 hours. This makes it easier to mix, improves the quality of the bricks and lessens the likelihood of cracks caused by shrinkage.

The earth is piled up on a flat surface near to the brick production area, and a "crater" dug in the middle of it is filled with water. The aim is to produce a homogeneous mixture in a plastic state.

It can also be trodden directly in a ditch. This rather arduous work can also be done with a mixer.

The amount of water needed is quite considerable and the proximity of water is one of the considerations to be taken into account in choosing the brick production area. Given that the mixture is made up of one third water, a daily production of 500 bricks measuring 30 × 15 × 10 cm (by a team of 4) requires 650 litres of water.

Stabilization

Vegetable or animal fibres are often added. In 112 Peru a type of grass which grows on the upper



FIGURE 161: THE ROOF IS THATCHED WITH ICHU GRASS, WHICH IS ALSO USED IN THE ABODE PRODCUTION (PERU).

Luc Basin

plateaus (Ichu-Fesuca) is used. In Trinidad, a plant with a strong durable fibre chopped into pieces (*Sporobulus Indicus*) is used; in Africa, millet husks. In Iran, rice husks, small palm leaves as well as goat and camel hairs are used to improve the bonding. In Mexico, pine needles. Fibres make up 20 to 30% of the volume of the bricks (30 gm per brick measuring 23 × 11 × 7). The fibres are added after the water has been mixed into the earth.

In Australia, Middleton suggests that 56 to 67 kgs of straw are required to produce 1000 bricks measuring 45 × 30 × 10 cm (or 4 to 5 kgs per m³ of brick).

In Egypt, in building the village of Gourna, Hassan Fathy used 20 kgs of straw for every 660 bricks measuring 23 × 17 × 7 cm, equivalent to 1 m³ of brick.

The vegetable fibres are normally mixed into the mud and left to soak for quite a long time to allow the non-fibrous matter to decompose.



FIGURE 162: THE KHAN (CRAFTSMEN'S AREA) IN THE NEW VILLAGE OF GOURNA (EGYPT).

CRA Terre

In the U.S.A., research has been carried out to determine the extent of the decomposition of fibres in adobe bricks. Bricks over a hundred years old were found to contain intact dry fibres, from which it was even possible to identify the species.

Apart from fibres, conventional stabilizers can also be used: cement, lime, bitumen. The latter has been the subject of more specific research with regard to adobe (cf. chapter on Stabilization.)

Successful stabilization depends on good mixing in. Stabilizers in powder form are mixed into dry earth, whereas bitumen emulsions are incorporated into pre-moistened soil.

Method for manual mixing in of bitumen

1. Measure out a given quantity of dry earth: e.g. 50 wheelbarrow loads.
2. Wet and allow to rest for 24 hours.
3. Take 4 wheelbarrow loads of earth, add water, and mix it well in until a doughy consistency is obtained.
4. Pour all the emulsified bitumen into this mixture, mix well.
5. Incorporate the resulting mix into the remaining earth, with a vigorous blending action.

A good mix can be recognized by its uniform colour. When vegetable fibres are used, they are added after the bitumen mixture, which would otherwise be absorbed by them.

Moulds and how to use them

Moulds are generally made of wood but can also be made of metal (fig. 163). They can be reinforced at the corners either with metal strips or using any other system. Very smooth internal surfaces, made of formica for example, prevent the earth from sticking and give the bricks a neat finish, as well as making the moulds easier to clean.

Brick dimensions vary widely and depend largely on local custom. Small moulds can easily be used one-handed, but will slow brick production and require more mortar. Larger bricks on the other hand will make the walls stronger and

easier to build, but will take longer to dry, be heavy to handle and be more likely to crack. A person working alone will find it difficult to handle a mould greater than 80 cm in length. There are many types of multiple moulds which produce several bricks at a time, particularly in the industrial production units of New Mexico (U.S.A.), where moulds with up to 50 sections are used, considerably speeding up production rates.

Bricks can be square or rectangular. The latter will be easier to use if they are the same width as the wall, provided half-bricks have also been produced to avoid vertical joints between courses. The bonding patterns of rectangular bricks are more complex, and the bricks should measure as follows: length = (2 × width) + width of joint.

Filling the mould

This can be done in two ways:

- **Manually:** the earth is in a plastic state and is pushed into the mould.
- **Mechanically:** the earth is in a liquid state and is poured into the mould.

In the case of the manual operation, a very simple test can be carried out to check that the water content is correct. This consists in making a V-shaped groove 8 cm deep in the mix with a stick sharpened into a right-angled point. This should leave a clear mark. The sides of the groove will swell towards each other but should not meet (fig. 166).

a) **"Ball" moulding or so-called wet impact method ("Golpe de agua")**

The mould is placed on the ground and several lumps of earth are thrown into it starting with the corners.

FIGURE 163: 1. MULTIPLE WOODEN MOULD, PRODUCING 6 BRICKS 14 x 29 x 9 cm.

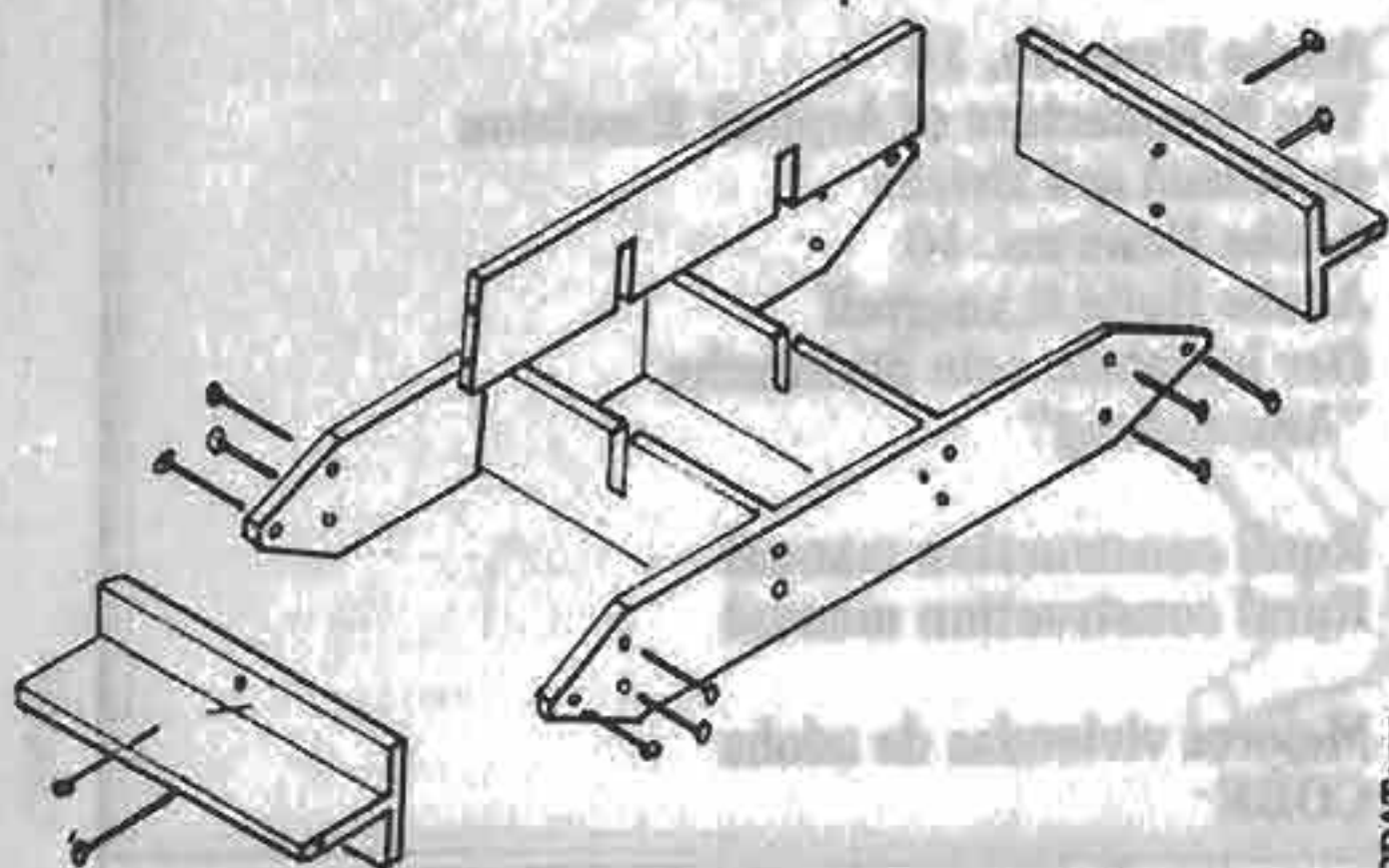

2. IRON MOULD PRODUCING THREE BLOCKS 19 x 39 x 9 cm.

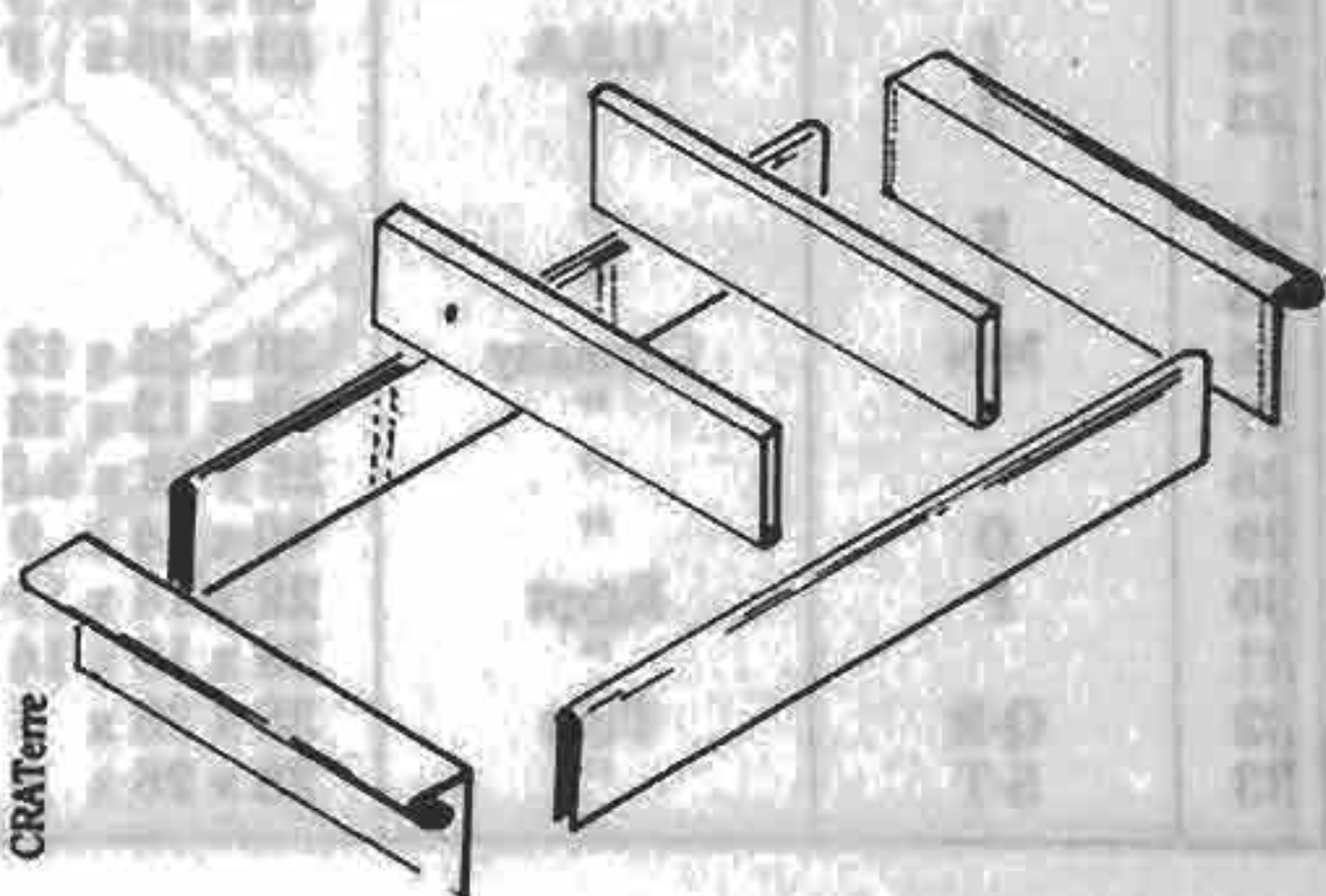

FIGURE 166



The earth is pressed down to eliminate any air and the surface is leveled off removing excess

mud. The mould is removed vertically in one brisk movement. The compaction effect resulting from the balls of earth having been thrown into the mould creates a lubricating film of water between the mould and the earth which makes the removal of the earth easier.

The surface on which the bricks are left to dry will have been prepared by covering it with sand, straw or paper. Each time the mould is removed it is scraped and thoroughly washed to keep the surfaces smooth. The mould should always be wet. The use of a mould without a base results in a better rate of production but gives a less smooth finish to the sides of the brick.

**INVENTORY OF ABODE
BRICK MOULDS (SEE FIGURE 165)**

No.	Mould	Country	l x w x h (cm)	Source
1	A	Mexico	40 x 30 x 8	Sociedad de Arquitectos Mexicanos
2	A	Mexico	40 x 20 x 8	
3	B	U.S.A.	48 x 19 x 11	Making the adobe brick
4	C	Peru	50 x 24 x 16	Construyendo con adobe
5	C	Peru	40 x 19 x 12	
6	D-E	Australia	61 x 30 x 15	Earth Wall Construction
7		"	46 x 30 x 13	
8		"	46 x 23 x 13	
9		"	46 x 30 x 10	
10		"	46 x 23 x 10	
11		"	41 x 20 x 10	
12	F	Egypt	44 x 24 x 12	Naissance de l'urbanisme dans la vallée du Nil, and Directory of the Bible
13		"	38 x 18 x 14	
14		"	22 x 14 x 11	
15	G	Tunisia	20 x 10 x 5	Cahier des Arts et Techniques d'Afrique du Nord
16		"	20 x 10 x 4	
17		"	20 x 10 x 3	
18	H	France	40 x 30 x 55	Toulouse area N.Sarrazin Diploma of Architecture
19		"	40 x 15 x 5	
20		"	30 x 14 x 8	
21		"	35 x 27 x 5	
22	I	U.S.A.	53 x 25 x 9	Adobe News no. 14
23	J	"		The Manufacture of Asphalt Emulsion stabilized soil Bricks
24	K	"		Adobe News no. 10
25	L	"		Adobe Build it yourself
26	M-N	Germany	38 x 25 x 12	Der lehm bau, sein praktische "Anwendung"
27		"	25 x 12 x 12	
28		"	25 x 12 x 6.5	
29	O	"	40 x 14 x 9	Rural construction manual
30	P	Egypt	22 x 14 x 11	Rural construction manual
31		"	38 x 18 x 14	
32	Q-R	Peru	38 x 38 x 8	Mejores viviendas de adobe
33	S-T	"	28 x 28 x 8	COBE

FIGURE 165: SMALL SELECTION OF ADOBE BRICK MOULDS

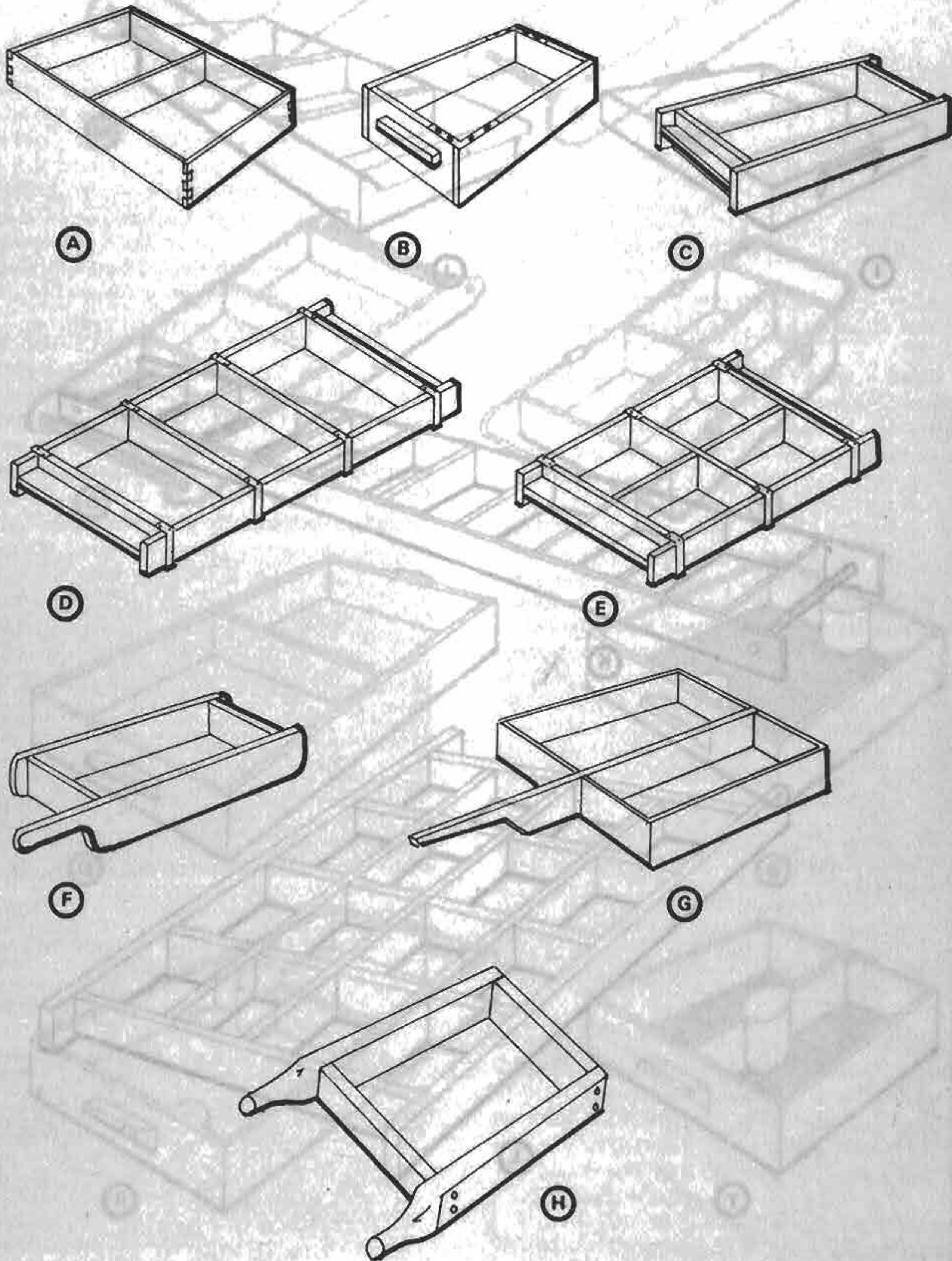
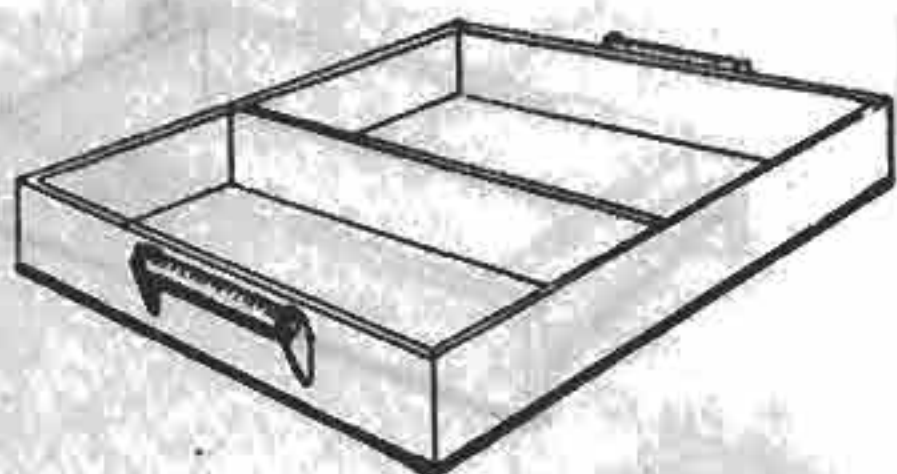
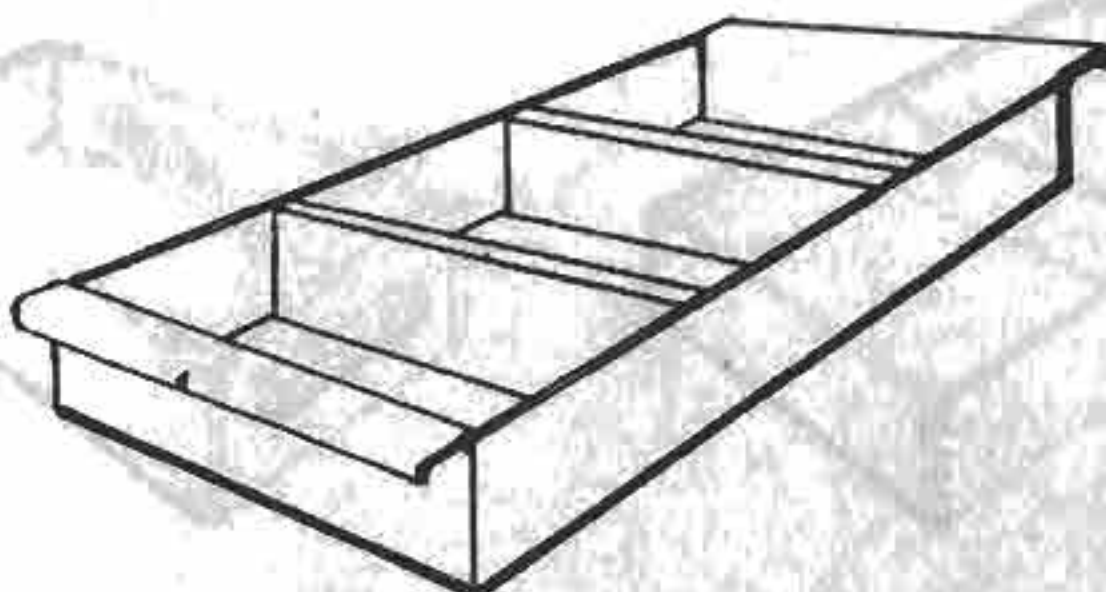

FIGURE 165: (CONTD.)



I



J

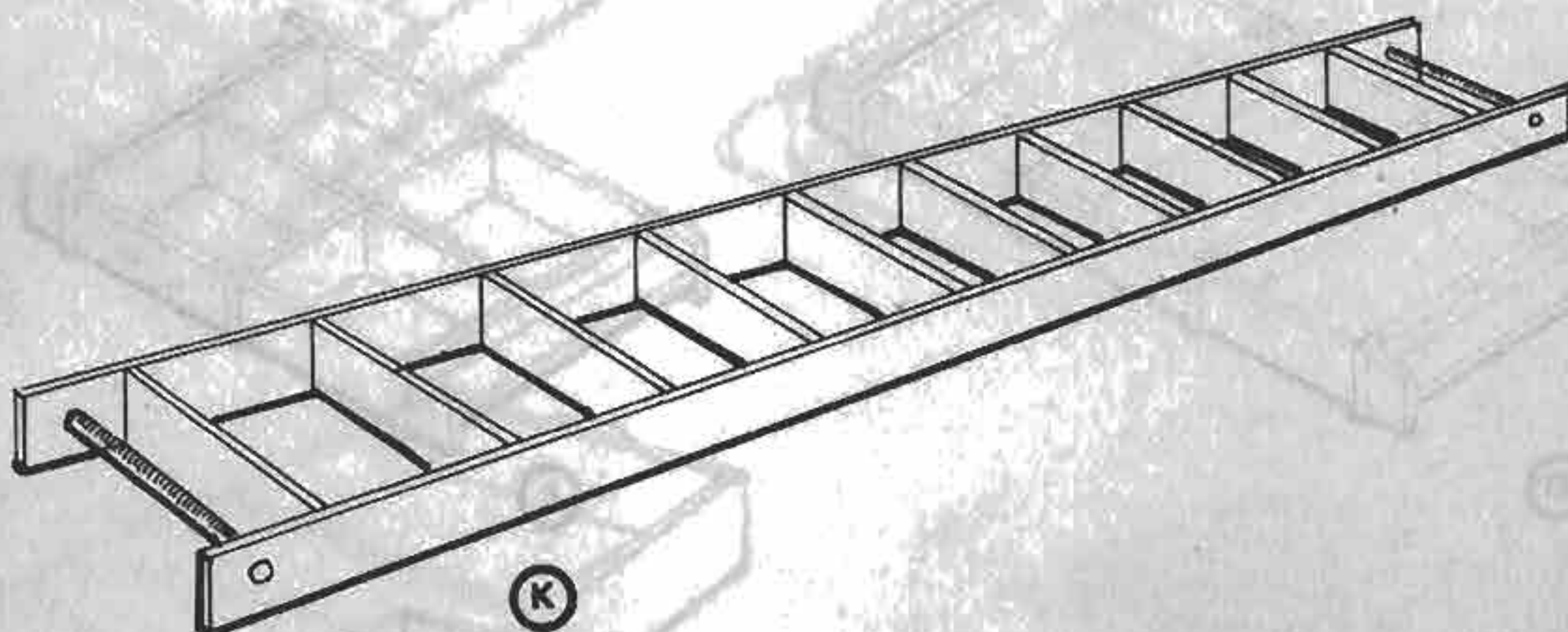

K

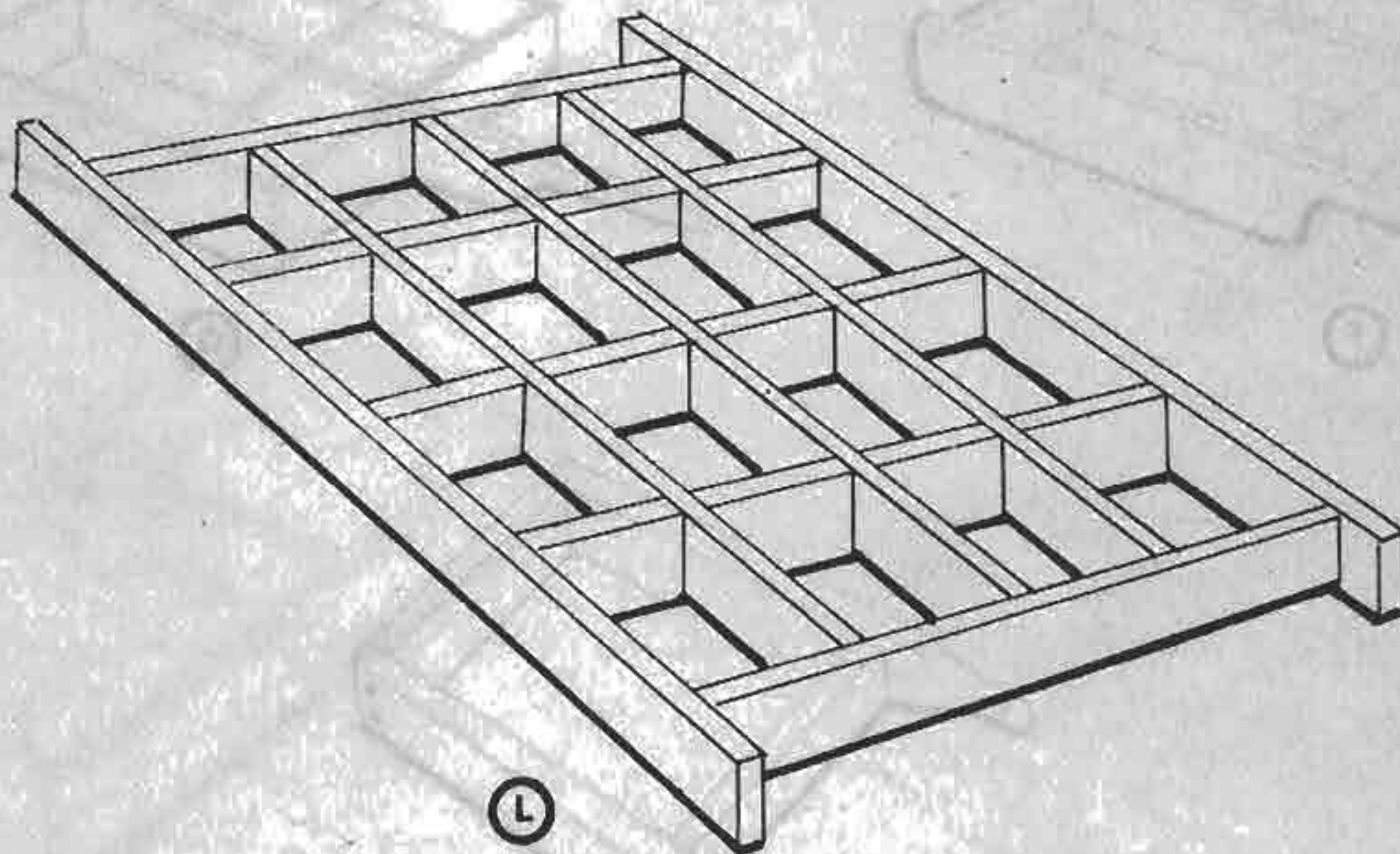

L

FIGURE 165: (CONTD.)

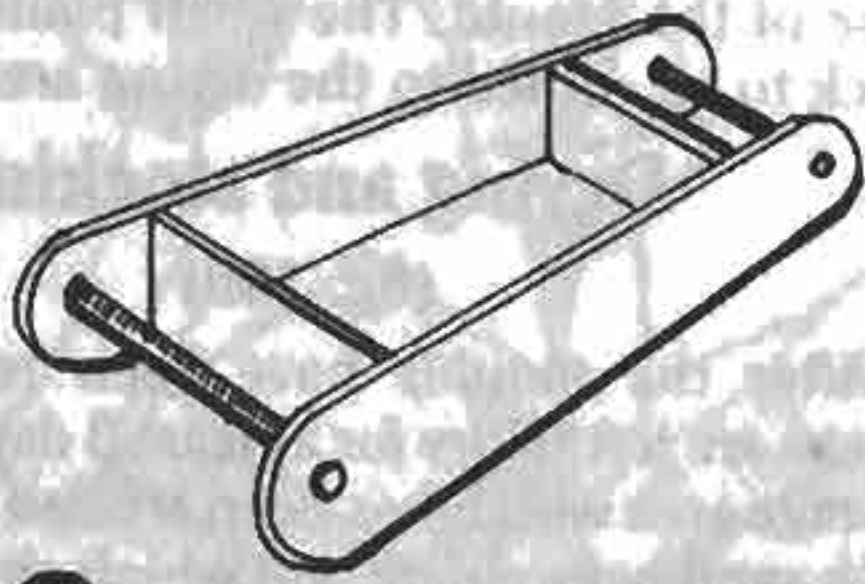

M

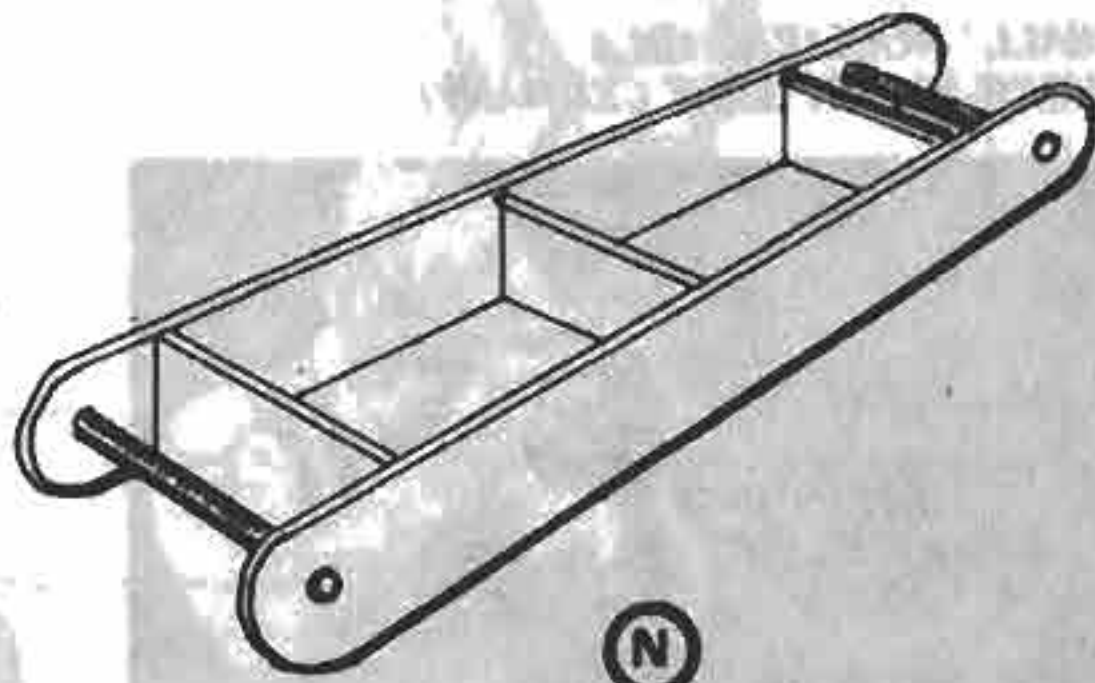

N

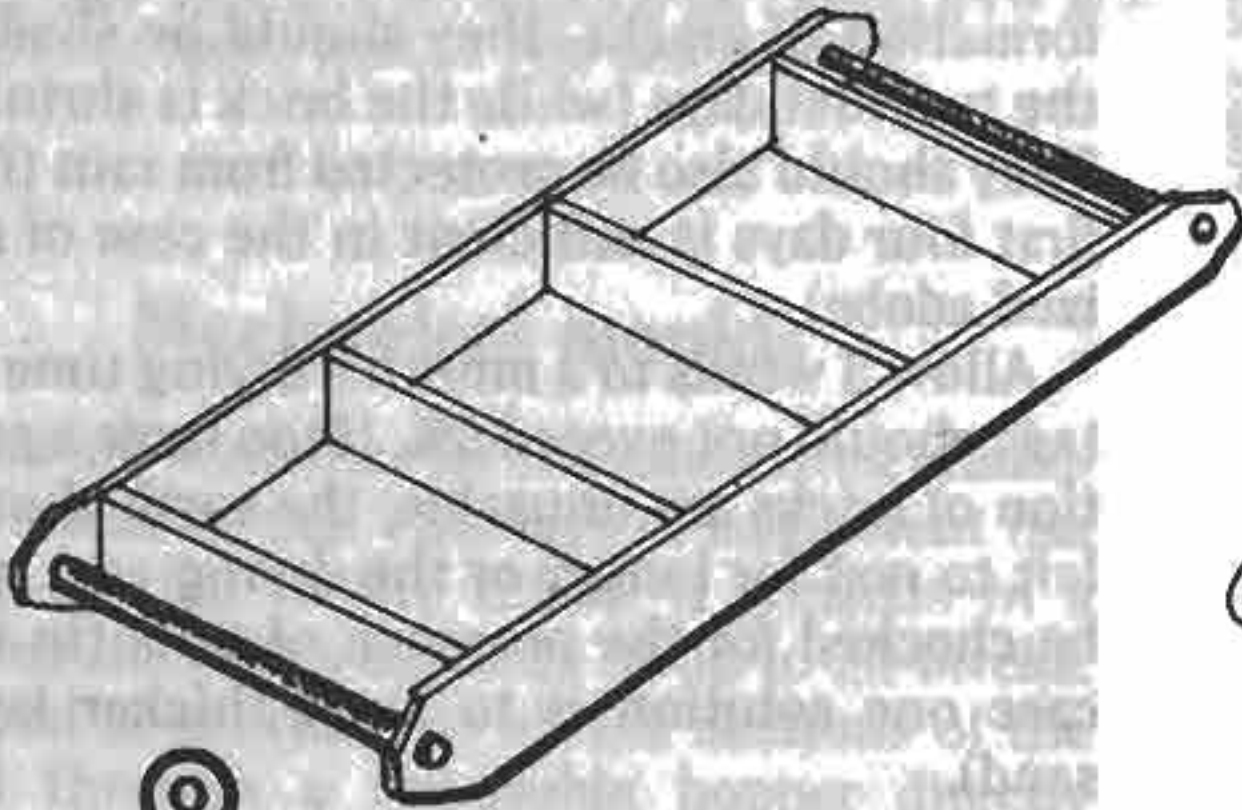

O

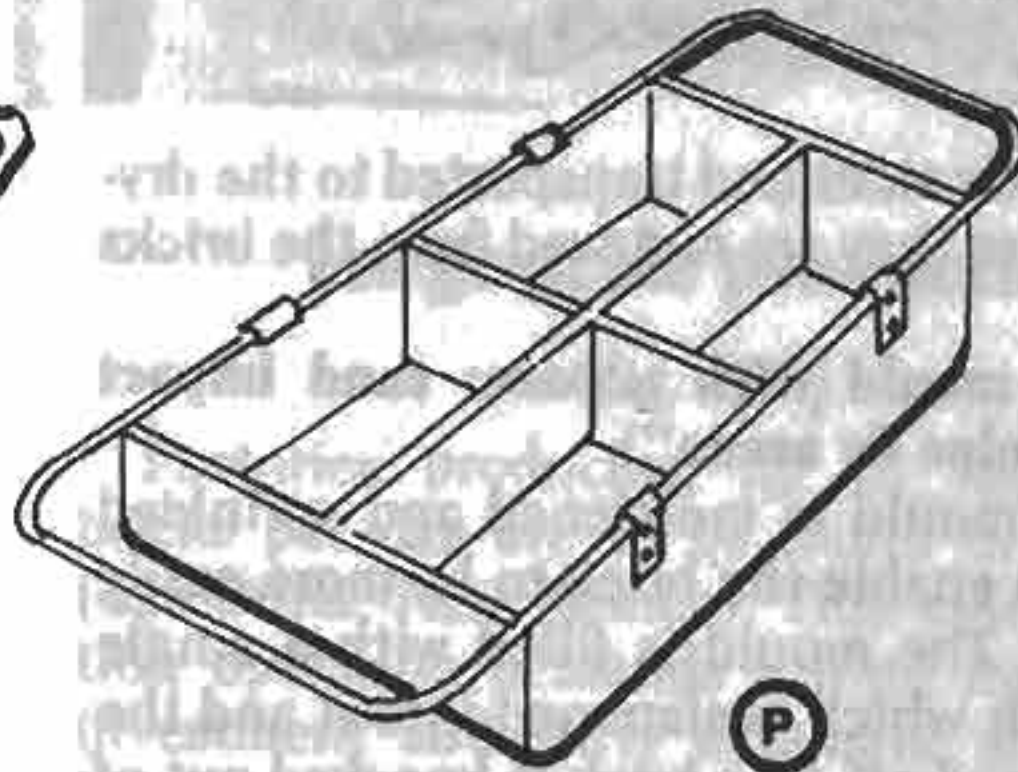

P

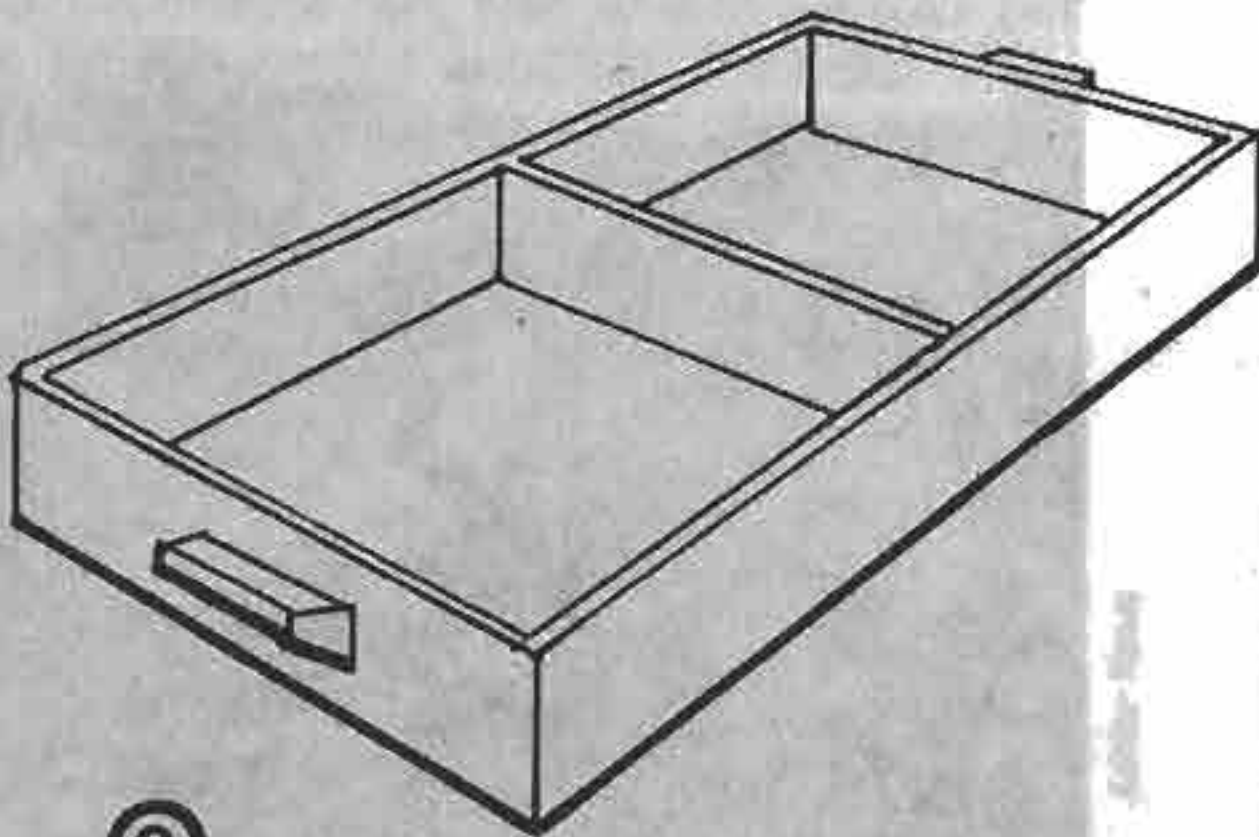

Q

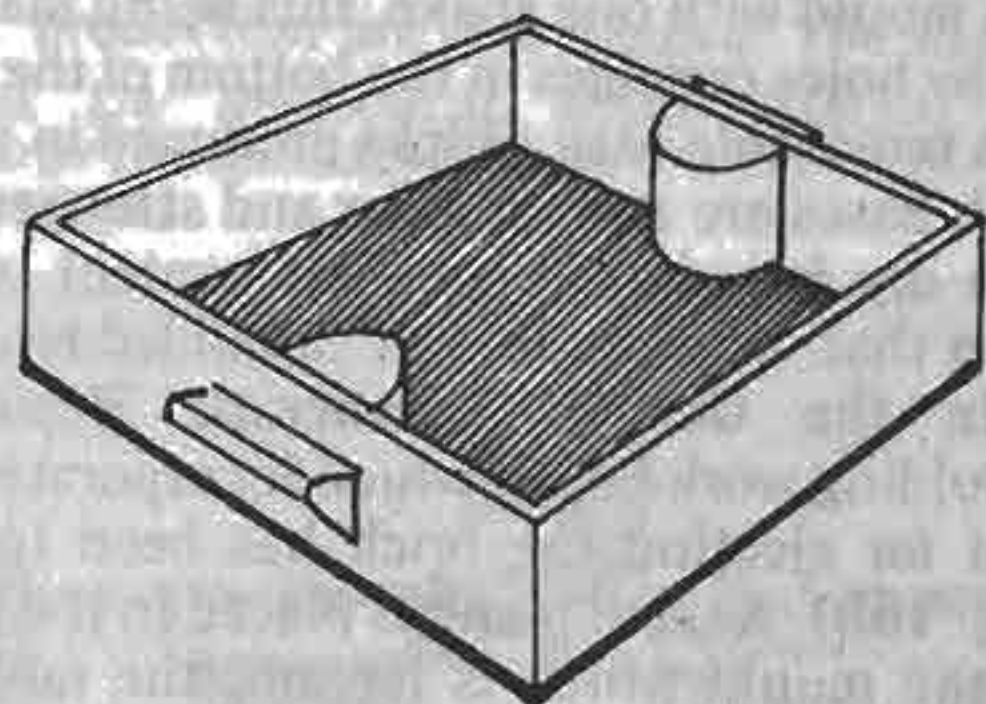

S

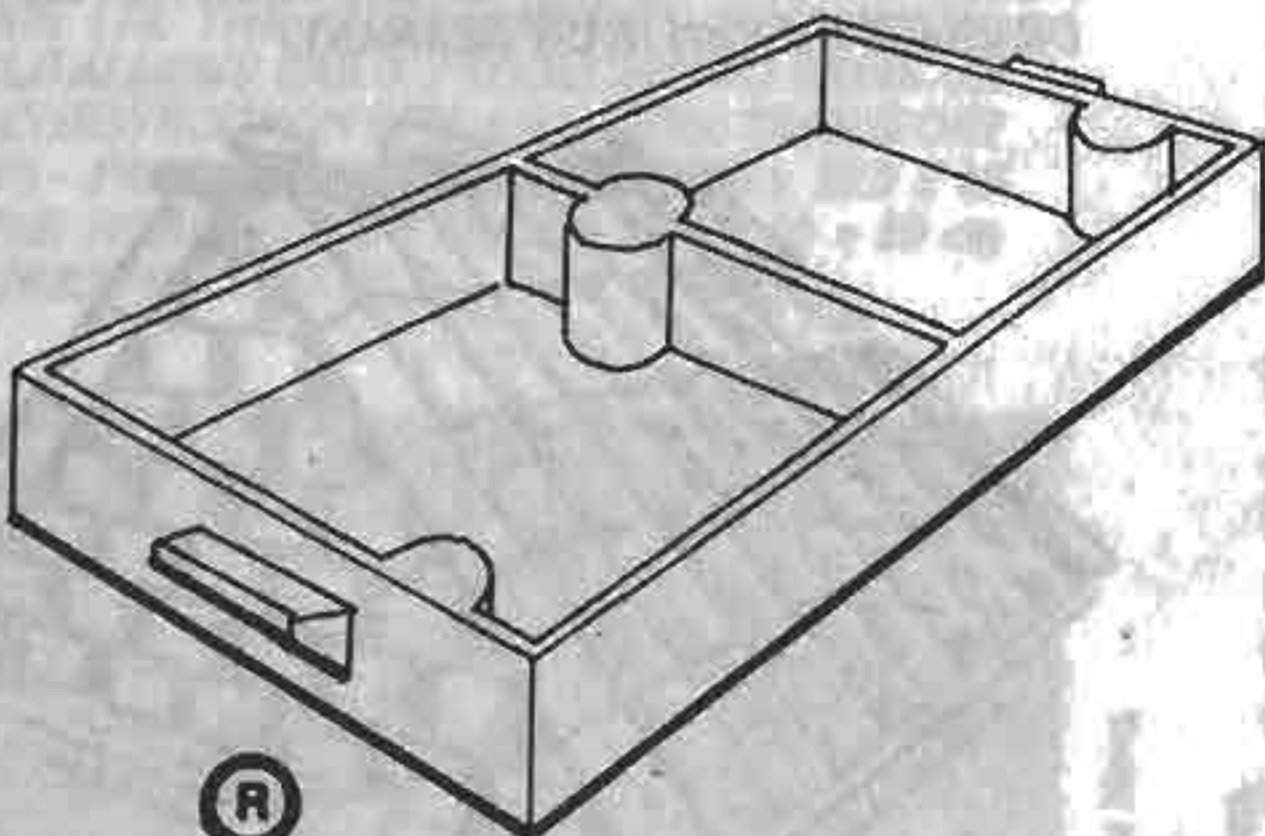

R

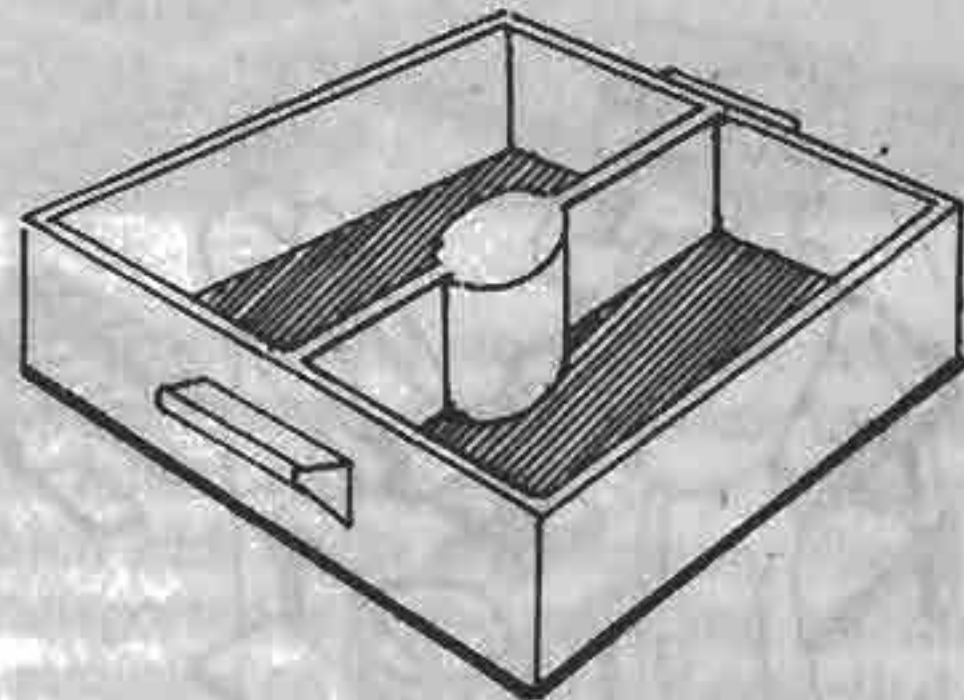

T

In the German Democratic Republic filling the moulds is done on a work-bench (fig. 167). The small moulds without bases are filled,

FIGURE 167: "BALL" MOULDING ON A WORK-BENCH (EAST GERMANY)



Pollack, Richter

placed on their sides and transported to the drying area where they are removed from the bricks (ref. 23).

b) Using a mould with a base: sand impact method ("Golpe de arena")

Here the mould is moistened and sprinkled with sand to enable the brick to be more easily shaken out. The mould is filled with a single lump of earth which is slammed into it and the surplus scraped off. The brick is knocked out of the mould with one shake, this being made easier by holes or ridges in the bottom of the mould or a removable base. Bricks produced in moulds with bases are more regular and stronger. They also dry faster, as their water content is lower than that of "water impact" moulded bricks.

In the German Democratic Republic a moulding work-bench which incorporates a system for ejecting the brick has been invented (fig. 168). A small plank is placed in the bottom of the mould which is let into the table. The

FIGURE 168: MOULDING TABLE USED IN GERMANY; A FOOT-OPERATED LEVER EJECTS THE BRICK FROM THE MOULD

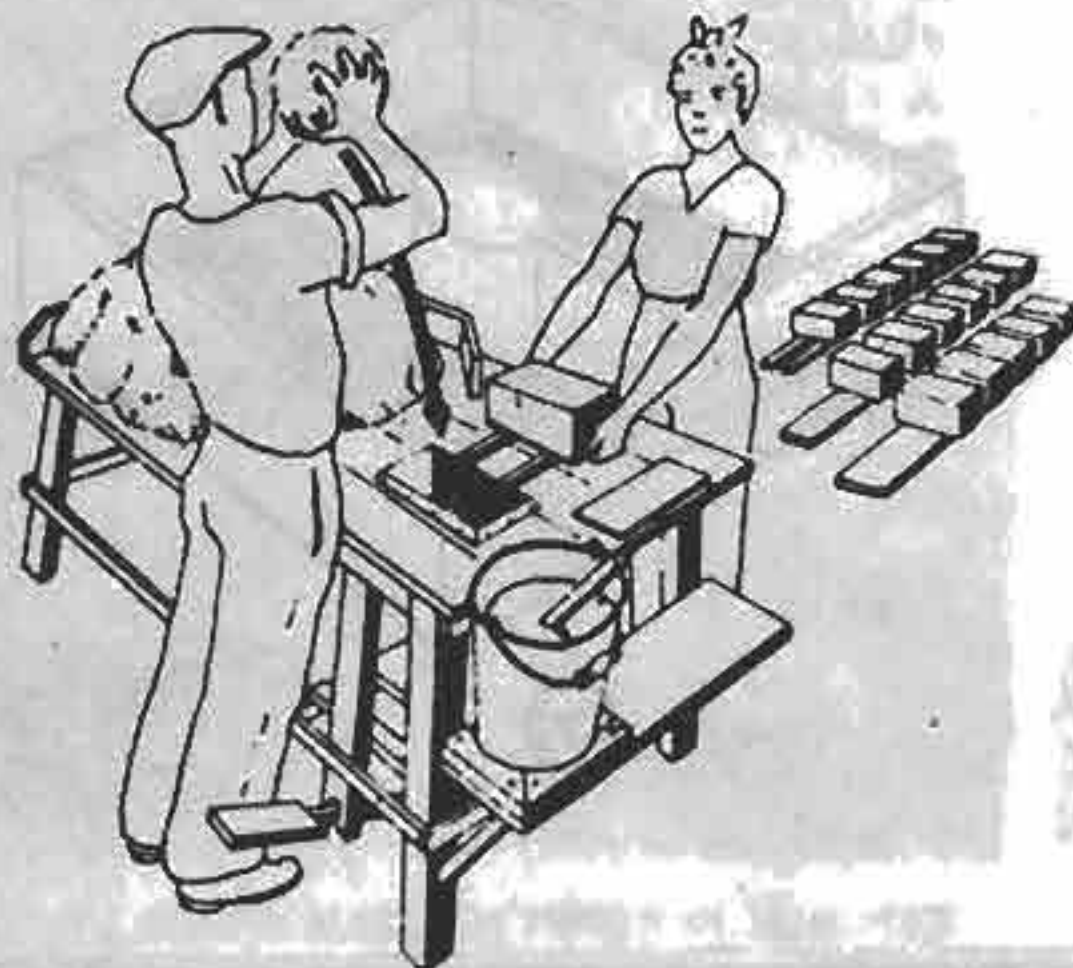

Pollack, Richter

earth is thrown into the mould, pressed in, and evened out. The brick is then mechanically ejected thanks to a pedal linked to the mobile base of the mould. The small plank allows the brick to be carried to the drying area.

Drying and stocking
(fig. 169)

After the moulds have been removed, the bricks are left to dry for at least 3 days on a clean storage area which has been leveled and covered with sand beforehand and which should be capable of holding 4 days' production. The bricks should be turned on their sides after 3 to 5 days to speed up the drying process. To avoid the formation of cracks, they should be shaded for the two first days (while the brick is shrinking). They should also be protected from rain (for the first four days is sufficient in the case of stabilized adobe).

Allow 3 weeks to a month's drying time. Wastage should not exceed 5%. If too large a proportion of bricks are unusable, the earth should be left to rest for longer or the drying area should be checked for the presence of salts (in which case one solution is to lay a thicker layer of sand).

FIGURE 169: ADOBE PRODUCTION IN MOROCCO



Francoise du Boisberranger

FIGURE 170: STOCKING OF BRICKS WITH WATER DRAINAGE SYSTEM (EAST GERMANY)

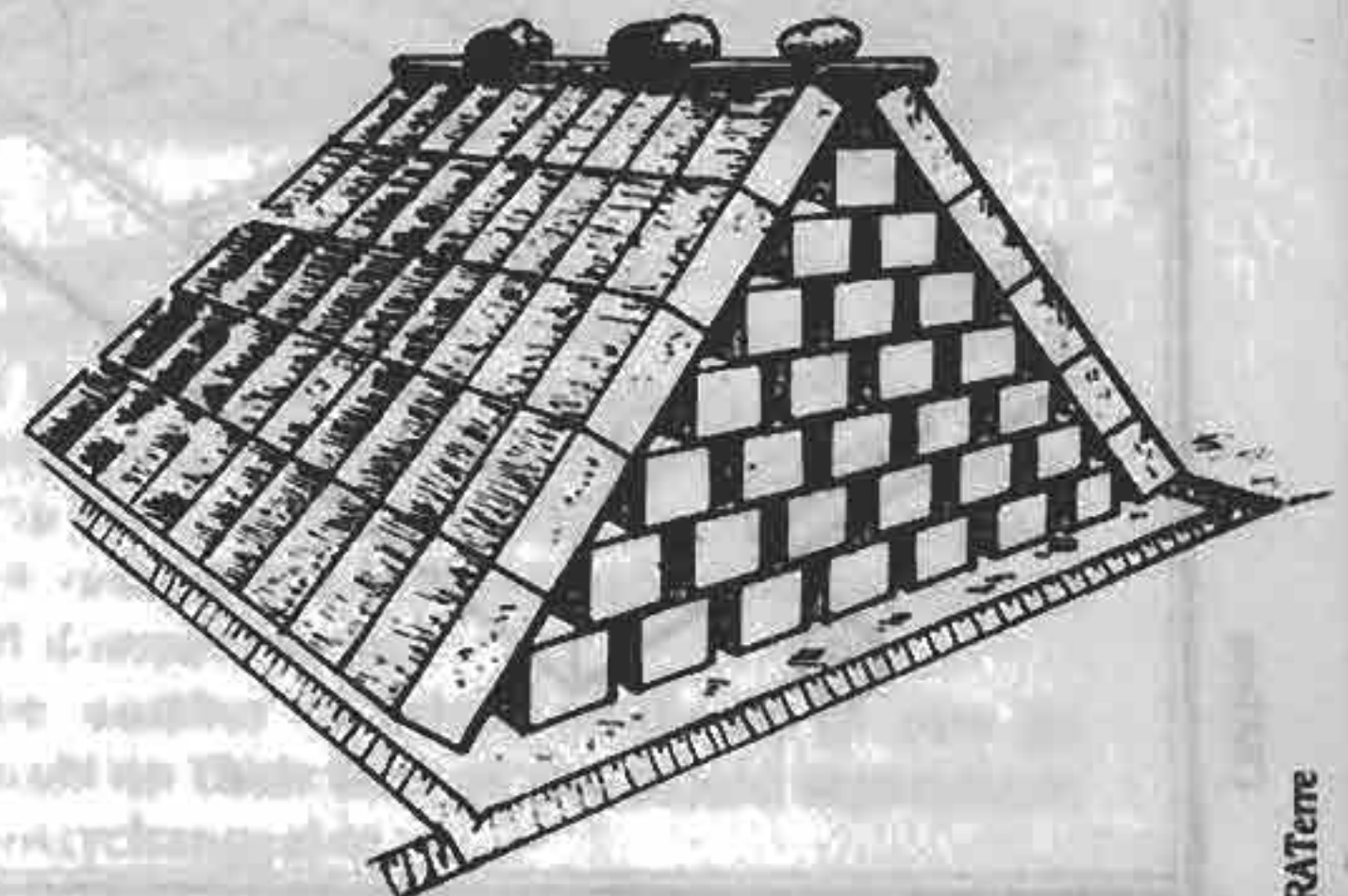

CRATerre



FIGURE 171: BENDING STRENGTH TEST.
ONCE DRY THE BLOCKS SHOULD BE CAPABLE OF SUPPORTING A MAN'S WEIGHT FOR ONE MINUTE.

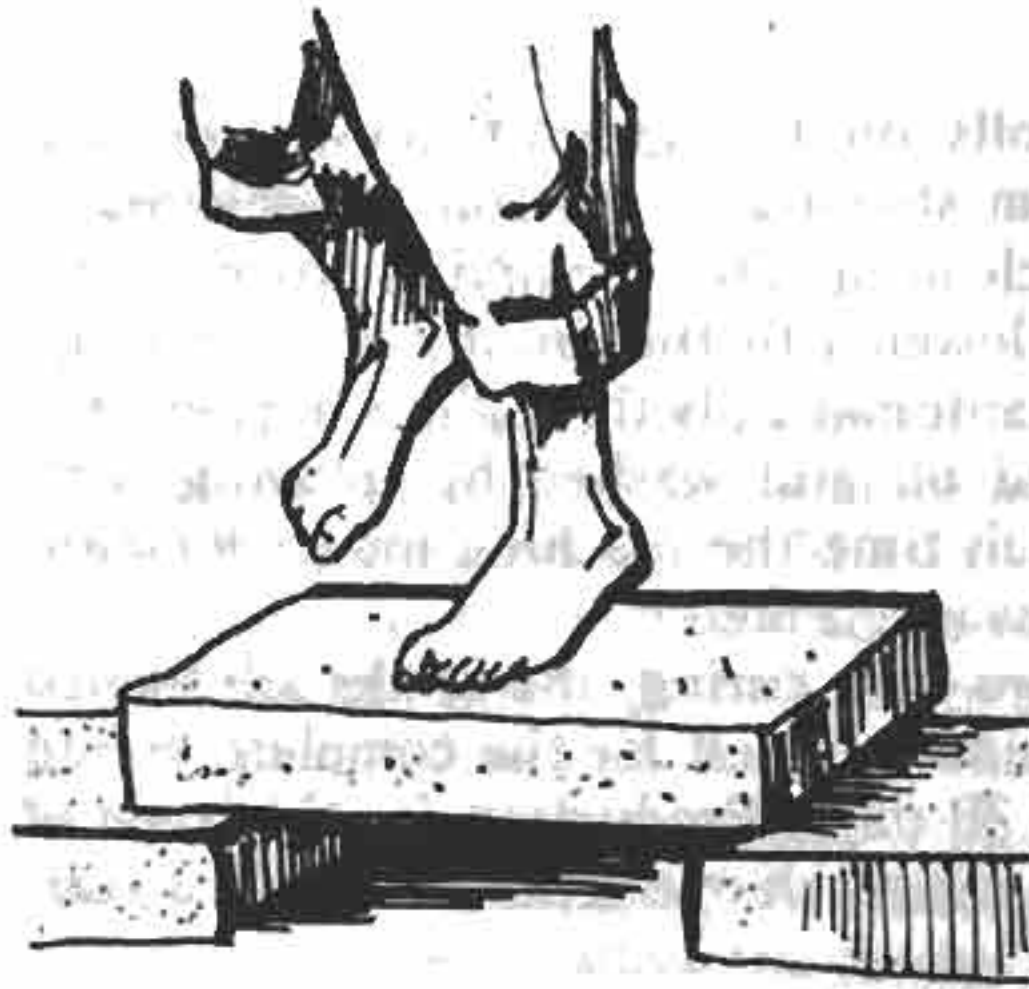

30 cm

Mechanical moulds

There are machines for the automated moulding of adobe bricks. This type of equipment has been perfected in the U.S.A. It consists in a large mould with a capacity of up to 50 bricks. The mud is poured into all the sections of the mould through a removable hopper directly from a "concrete" mixer. The largest machines can reach a production rate of 2250 bricks per hour. A lighter-weight automated mould "Adobemaster" (fig. 172) produces 1200 bricks per hour.

Large-scale production

(fig. 174)

Factories producing up to 18,000 adobe bricks per day are to be found in the U.S.A. (California, New Mexico). This kind of production operation demands a high initial capital investment and fairly extensive drying areas. Storage areas capable of absorbing several months' production are also needed. The earth

FIGURE 174: MECHANICAL MOULD MANUFACTURED BY THE HANS SUMPFF COMPANY IN FRESNO (CALIFORNIA)



A LOW COST MOBILE ADOBE MAKER THAT COMBINES QUALITY WITH PRODUCTION

ADOBEMASTER®

- Hand-poured - working in hot sun
- Produces 200 to 1200 bricks
- No labor to stop
- Two men operation
- Produces better bricks, cement bricks, bricks, masonry blocks, pavers, etc.
- Used in service operation
- Tested and proved product

DESIGN SERVICES **AUTHORIZED DISTRIBUTION**

BOX 2334 RUIDOSO, N.M. 88345

For SALES or LEASING of ADOBEMASTER, contact Howard Sumpff, David Smith, or Donald Lohr in Dallas, Texas (214) 357-1101. Design Services also offers total Adobe Design, Soil Testing, etc.

Adobe News

FIGURE 172: THE "ADOBEMASTER" MECHANICAL MOULD ALLOWS BRICK PRODUCERS TO WORK ON THE CONSTRUCTION SITE AND AVOID TRANSPORT COSTS - PRODUCTION: 767 BRICKS 35 x 25.5 x 10 cm PER HOUR OR 1259 BRICKS 35.3 x 10 x 10 cm PER HOUR (NEW MEXICO)

LARGEST ADOBE SUPPLIER IN ALBUQUERQUE'S NORTH VALLEY

NEW MEXICO EARTH

Manufacturers of classic mud Adobe, water-piped adobe and vesper Adobe

Visit our yard at Fifth and 21 Pecos St. in the North Valley.

17¢

TELEPHONE (505) 696-1271

The price, listed up in THE YARD. Prompt Delivery. Service Available. See our New Site.

Adobe News

FIGURE 173: ADOBE MANUFACTURER IN NEW MEXICO (U.S.A.)

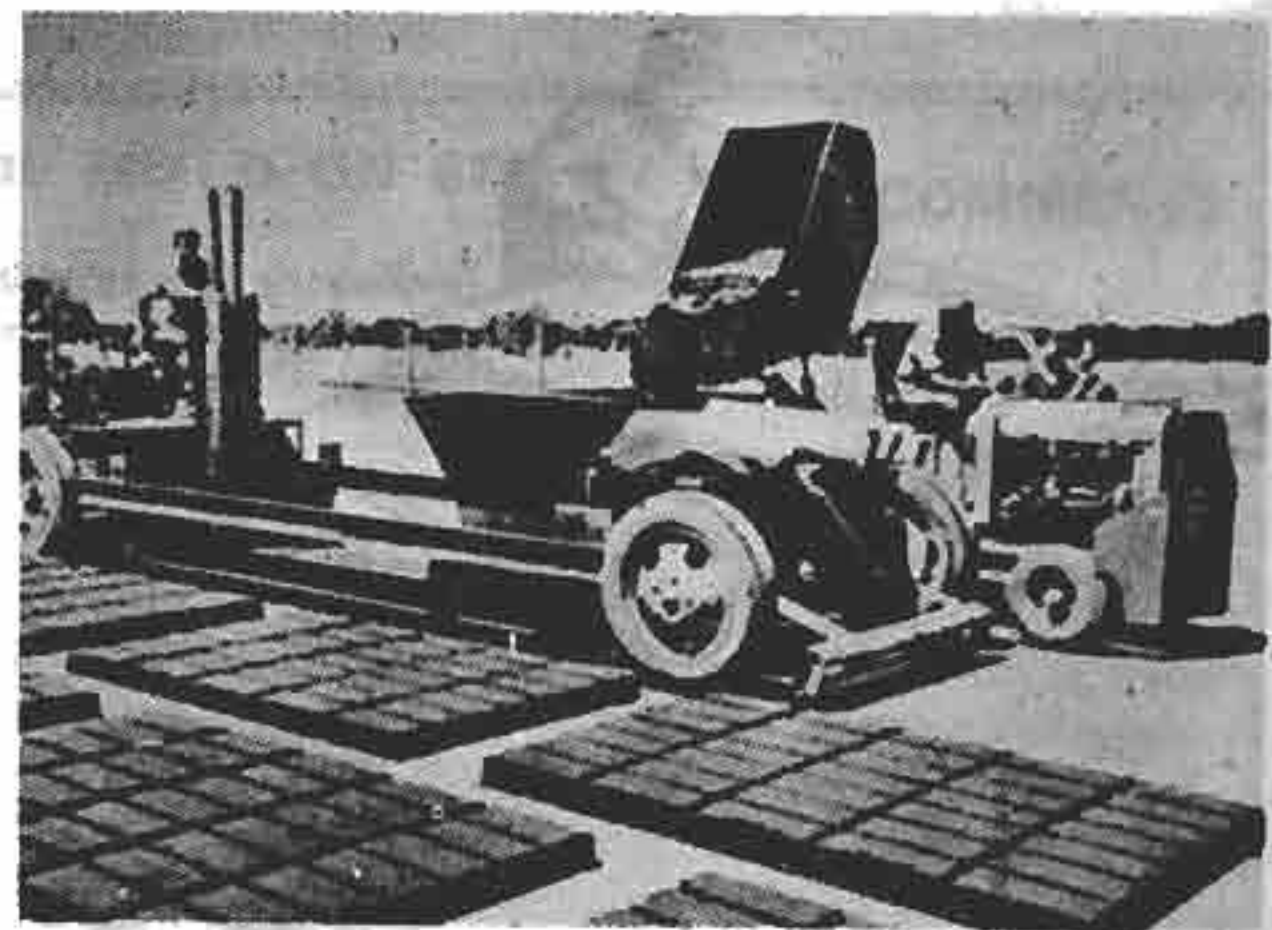

International Institute of Housing Technology - California

is excavated, sieved and mechanically crushed. A conveyor belt carries it into storage hoppers. It is then mixed into a paste in a horizontal mixer which adds water and bitumen. The mixture is transported into the moulding machine, which is mounted on tyres and self-propelled, in small dumper trucks.

The number of bricks produced in one go depends on their size, as the mould separations are interchangeable.

As it moves forward a strip of paper automati-

cally unrolls on the ground, preventing the bricks from sticking to the soil and making it easier to clean up after the drying process. The mould is lowered to the ground at each stage and filled automatically through its hopper. It is then lifted off and washed by spraying with water. Each time the machine moves forward, the process is repeated.

After two days curing, the bricks are turned on their sides and left for the complete drying period of 30 days. Production for this type of operation can reach over a million bricks a year.

Other methods

A manual system for cutting up a large "slab" of adobe and another mechanical method producing a continuous length of brick are two ways that have been devised with the aim of speeding up production.

a) Cutting up an adobe "slab"

According to this method, the earth is poured into a frame the height of which is the same as that of the required brick size and the sides of which are multiples of the required length and breadth. The mould is filled and the surface smoothed over, and the resulting "slab" is cut

FIGURE 176: CUT ADOBE "SLAB"

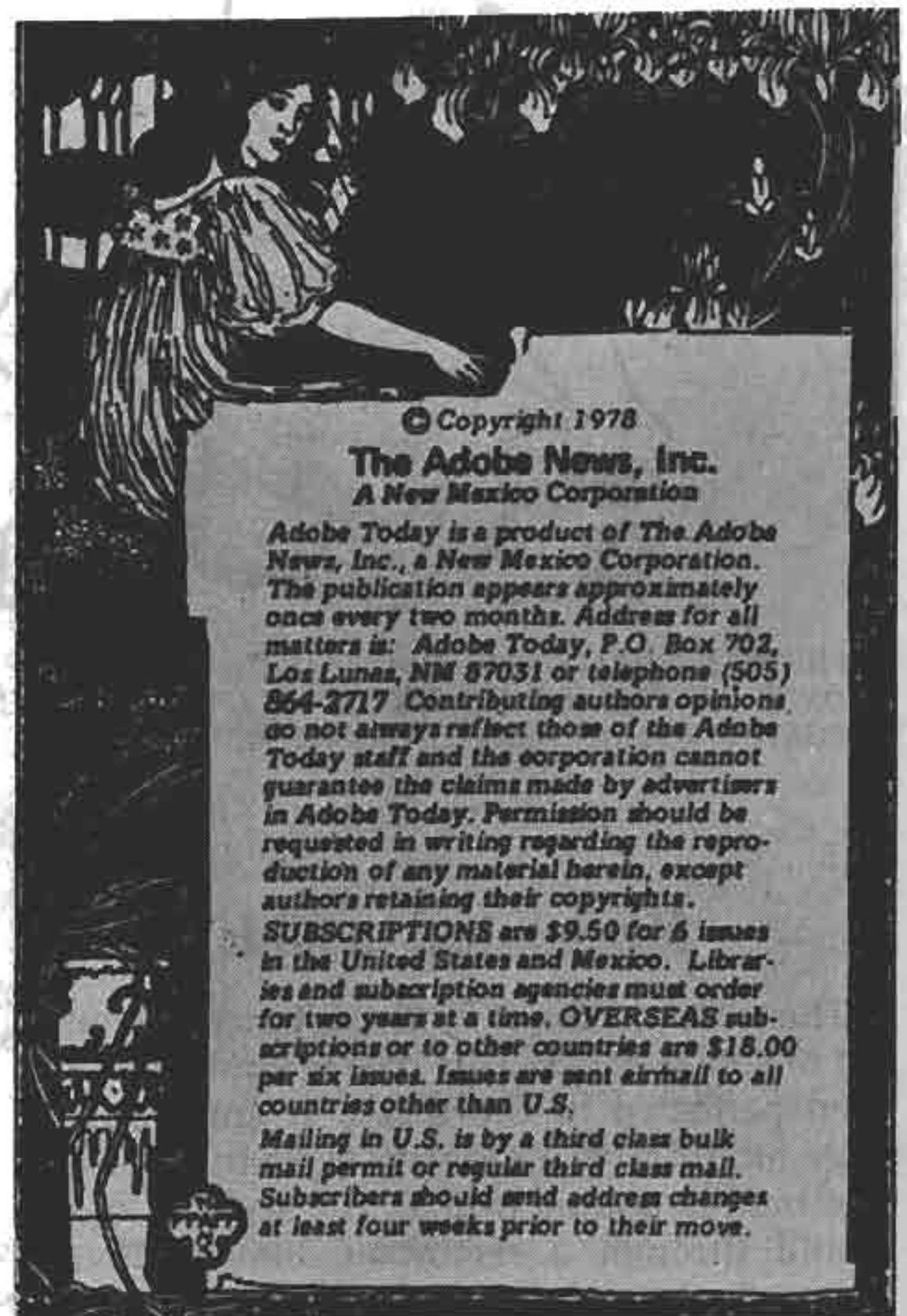
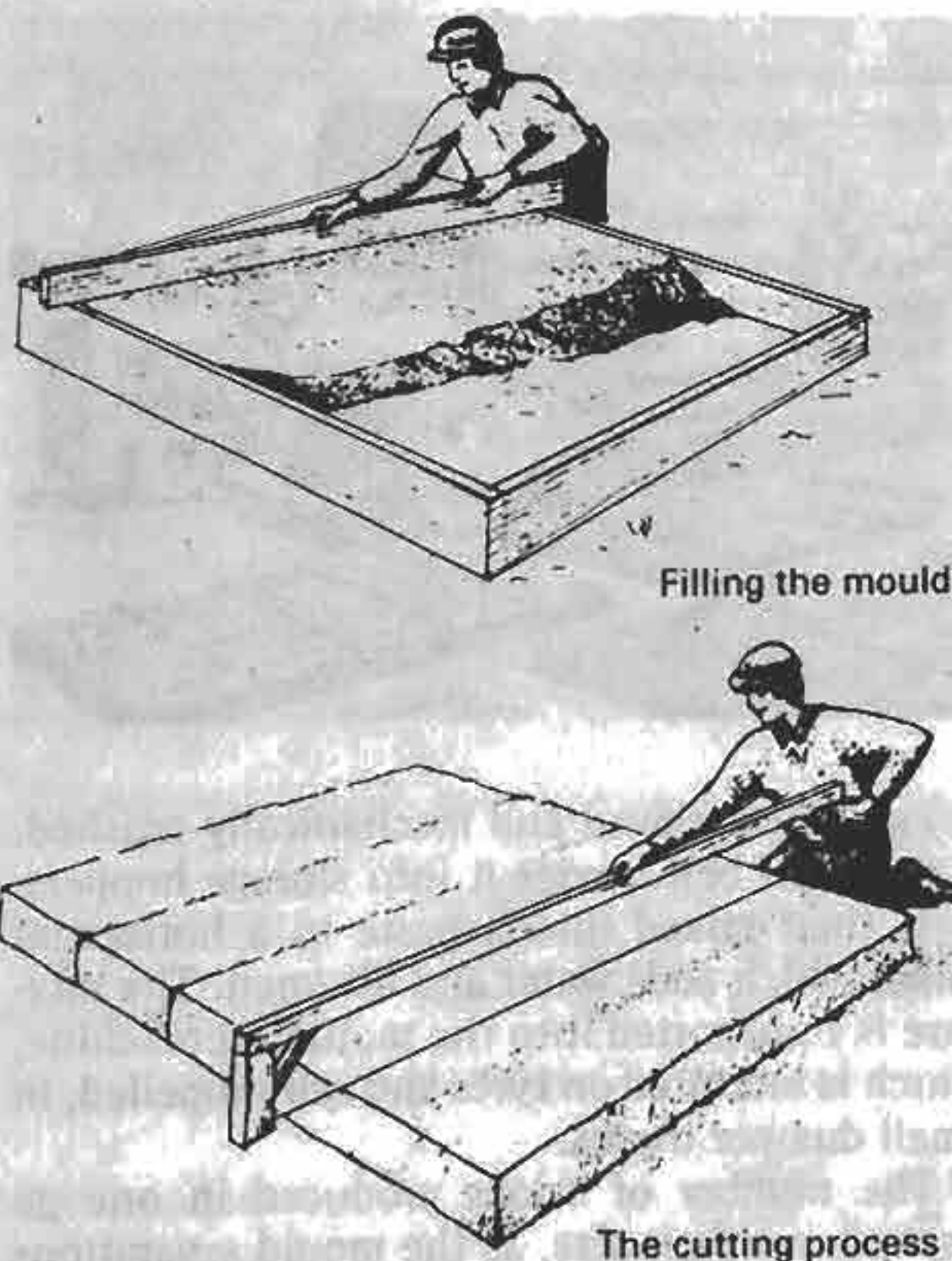

FIGURE 175: "ADOBE NEWS", A MONTHLY PUBLICATION SPECIALIZING IN ABODE CONSTRUCTION AND SOLAR-ENERGY HOUSES (U.S.A.) BECAME "ABODE TODAY" IN 1979.

with a blade. The system has been used by an amateur builder in Arizona (fig. 176). The mixed soil is poured into a large square frame placed on a plywood surface (2.5 × 2.5 m). Two to three hours later the frame is removed and the bricks are cut with a steel wire stretched on a wooden right-angle frame. The bricks do not have to be cut right through, as during shrinkage they will separate of their own accord. 70 bricks are obtained measuring 35 × 25 × 10. Two people can produce 300 to 400 adobe bricks per day in this way.

b) Extruded adobe

With some modifications ordinary brick-making equipment can be used to produce adobe bricks. Mixed earth is drawn through a shaping mould by suction and emerges in the form of a thick rectangular strip, the height and width of which correspond to the dimensions of the brick required. A special tool cuts the strip up into appropriate lengths. This process has been used in India (Delhi) to produce bitumen-stabilized bricks.

Wall building

When building with sun-dried bricks certain general principles which have evolved through experience should be adhered to, both with regard to design and application. Thus the maximum length of a wall between two corners should not exceed 6 m and longer walls should be supported by partition walls, reinforcement, or buttresses every 5 m. Openings must not exceed one third of the total surface area of the wall and should span not more than 1.2 m. Openings less than 1 m from a corner are to be avoided as this would weaken the corner. Finally, as a general rule, the ratio of width to height to length of a section of wall between two corners will be 1 : 8 : 12.

Mortars

The mortar used in the joints between the bricks should be of the same, or perhaps slightly stronger, composition as that of the bricks themselves. It should not, however, contain any gravel (sieved through a 3 mm mesh) or straw.

The most common mortars are listed below (fig. 178). Lime mortars are not recommended





for bitumen-stabilized bricks (ref. 6). The thickness of the joints varies between 1.5 and 2.5 cm. If too thick, they will weaken the wall. The pressure exerted on the joints by the load of the wall causes vertical shrinkage of 3 cm for every 3 m; this must be taken into account when putting doors and windows in place. Non-stabilized walls are often rendered, in which event the joints are scored to allow the render to adhere better. Stabilized bricks need no external protection and their joints are scored for decoration.

The quantity of mortar needed will depend on the brick dimensions. For adobe bricks 40 × 19 × 10 cm the volume required will be equal to one fifth of that of the wall. This formula takes account of the volume of mortar used in the joints and wastage during application.

Masonry bonding patterns

The bricks are laid in continuous courses in such a way as to allow all the walls of the building to go up simultaneously (fig. 179). The stresses are thus equally spread over the whole foundation. To avoid freshly laid joints being

FIGURE 178: VARIOUS MORTARS

MORTARS	PROPORTIONS TO BE MIXED ON SITE (1 wheelbarrow load = 60 litres = 17 shovelfuls)	COMMENTS
Sand lime 300 kg per m ³		conventional masonry
earth bitumen (cut back) 2%		strong enough but poor adherence
earth cement 225 kg per m ³ bitumen (cut back) 1%		
sand cement 400 kg per m ³ bitumen (emulsion) 3.3%		

compressed no more than 1 m in height should be built in any one day.

FIGURE 179: THE WALL MUST BE BUILT UP EQUALLY ALONG ITS WHOLE LENGTH

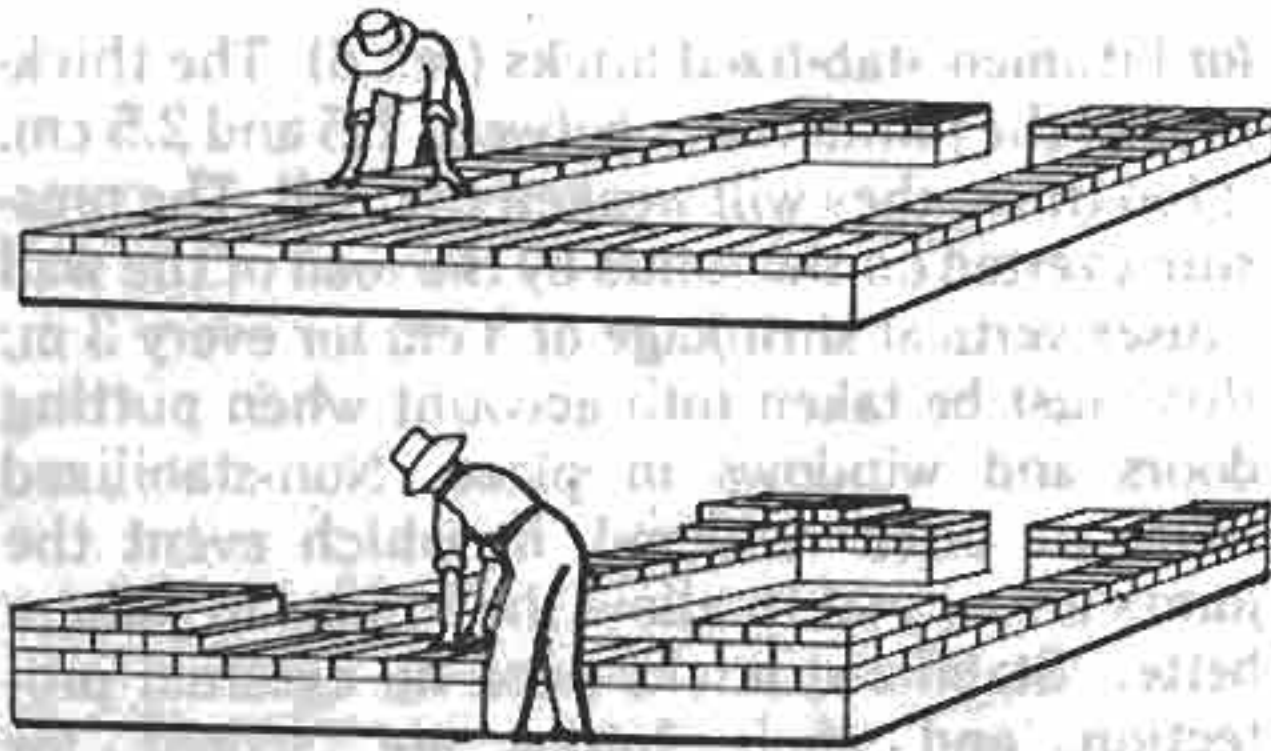

Oficina Nacional de Desarrollo Comunal - Pérou

All the usual masonry bonding patterns can be used for adobe bricks. As with fired bricks, two main principles have to be observed: the vertical joints of two successive courses should not line up with each other, and care must be taken to ensure good bonding at the corners. There are special bonding patterns for large blocks and square bricks (figs. 180, 181, 182.)

When a cement mortar is used it is important to wet the bricks before laying them to avoid their absorbing the moisture necessary for the hydration of the cement. On the other hand, bitumen stabilized bricks absorb practically no water and wetting them is superfluous.

It will take approximately 4000 adobe bricks (120 tons) to build the walls of a 150 m² house. One man can lay between 2.4 and 2.8 m³ per day using bricks 40 × 19 × 10. If the walls are 20 cm thick, this is equivalent to 15 to 17 m² per day; if they are 40 cm thick, 8 to 9 m² per day.

FIGURE 185: SITE ORGANIZATION FOR A TEAM OF FOUR

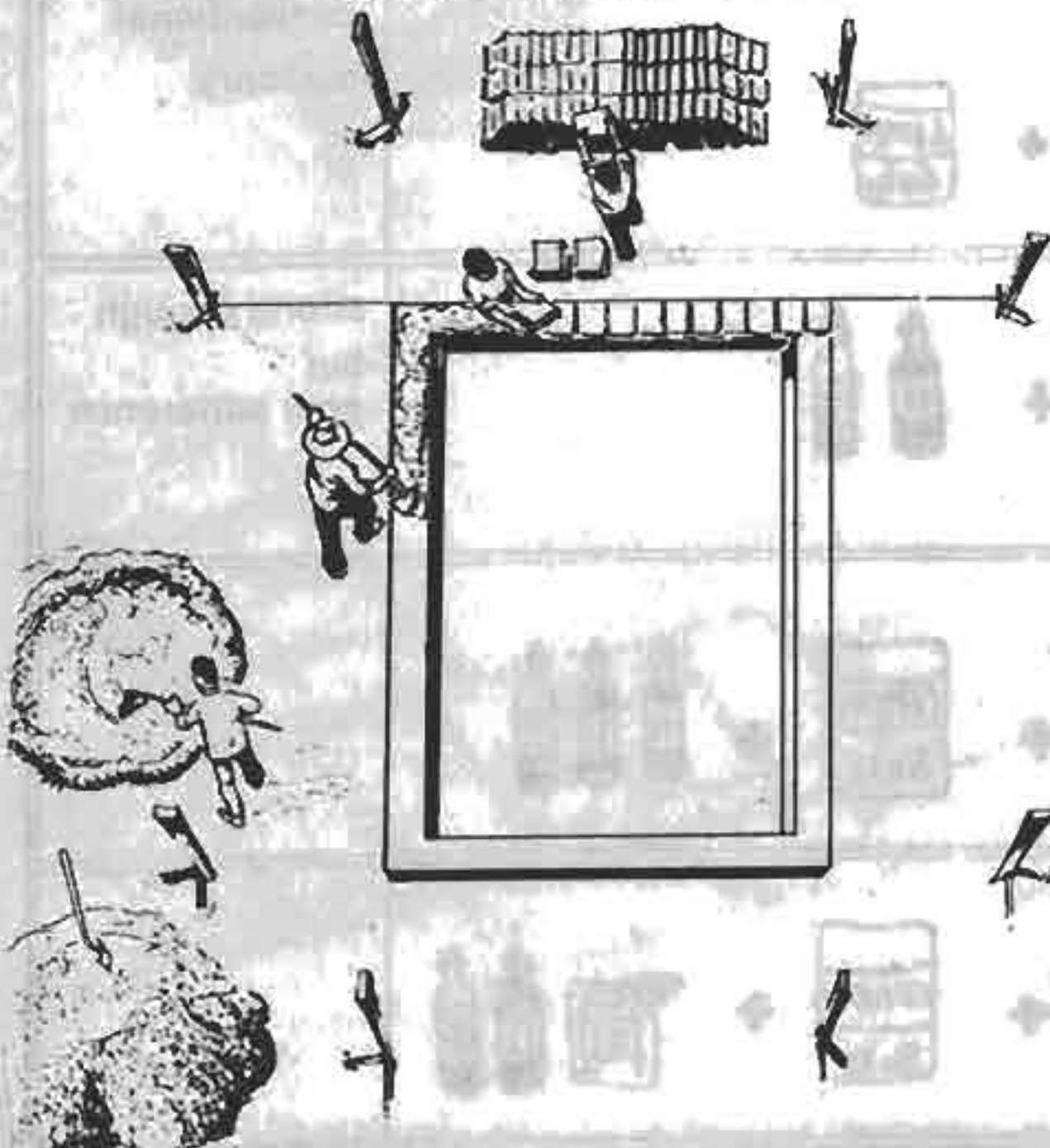

Adobe News

The work of a team of three will be organized as follows:

- one person applies the mortar to the wall;
- another brings the bricks, trimming them if necessary;
- the third lays them.

A fourth person could also be preparing the mortar (fig. 185).

There are many ways of achieving decorative effects by varying the bonding pattern. Decorating facades in this way is very common in Iran (fig. 186), in Nubia (fig. 187), in Morocco and in the Yemen.

FIGURE 186: KACHAN VILLAGE OF AMECHED ARDEHAL (IRAN)



Bijan Rafii

FIGURE 187: NUBIAN HOUSE NEAR ASWAN (EGYPT). THE DECORATIONS AND RENDERS OF THE FACADE ARE OFTEN DONE BY WOMEN.



Nathalie Sabatier

FIGURE 180: BONDING PATTERNS FOR
RECTANGULAR BRICKS.

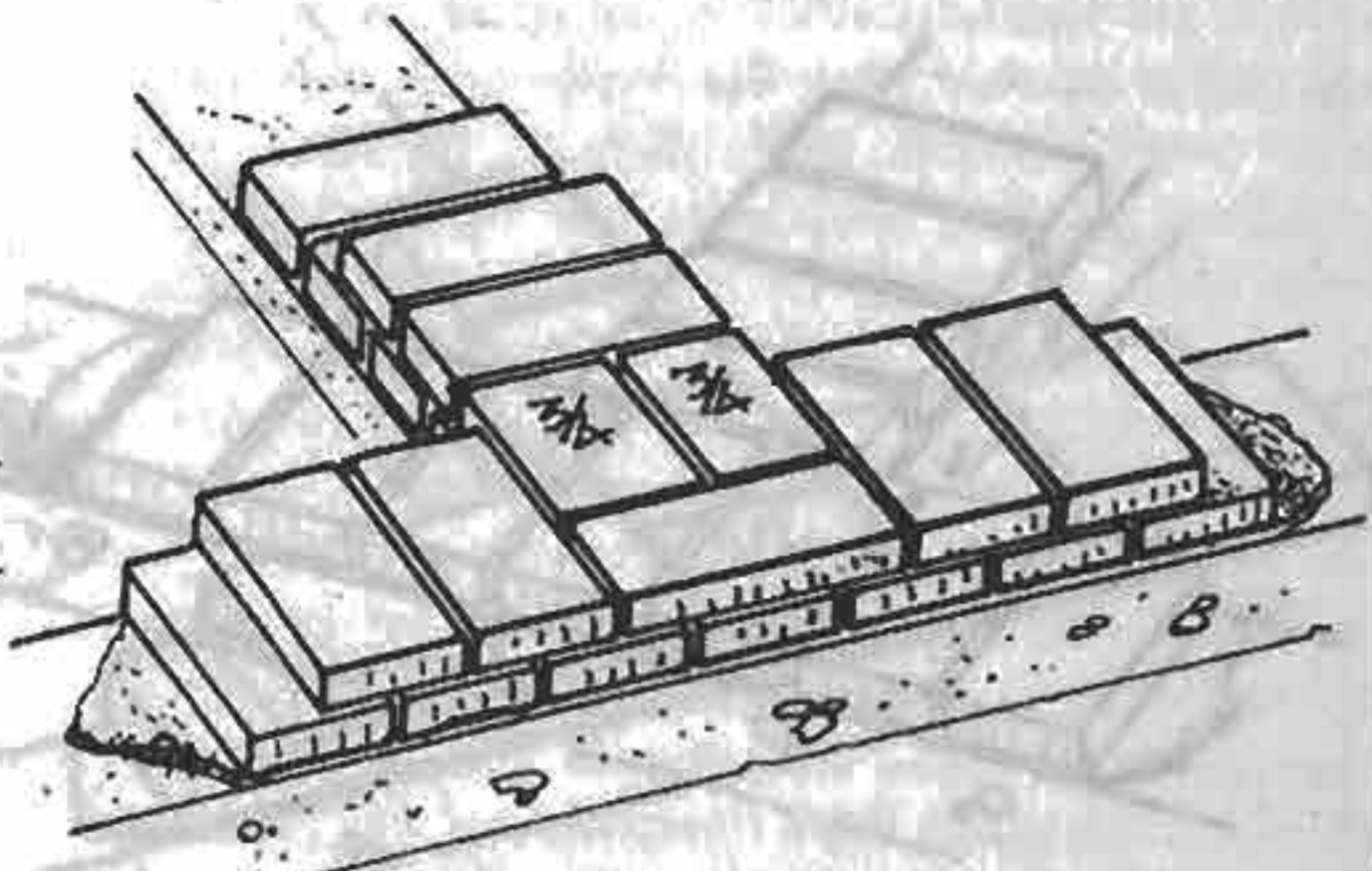
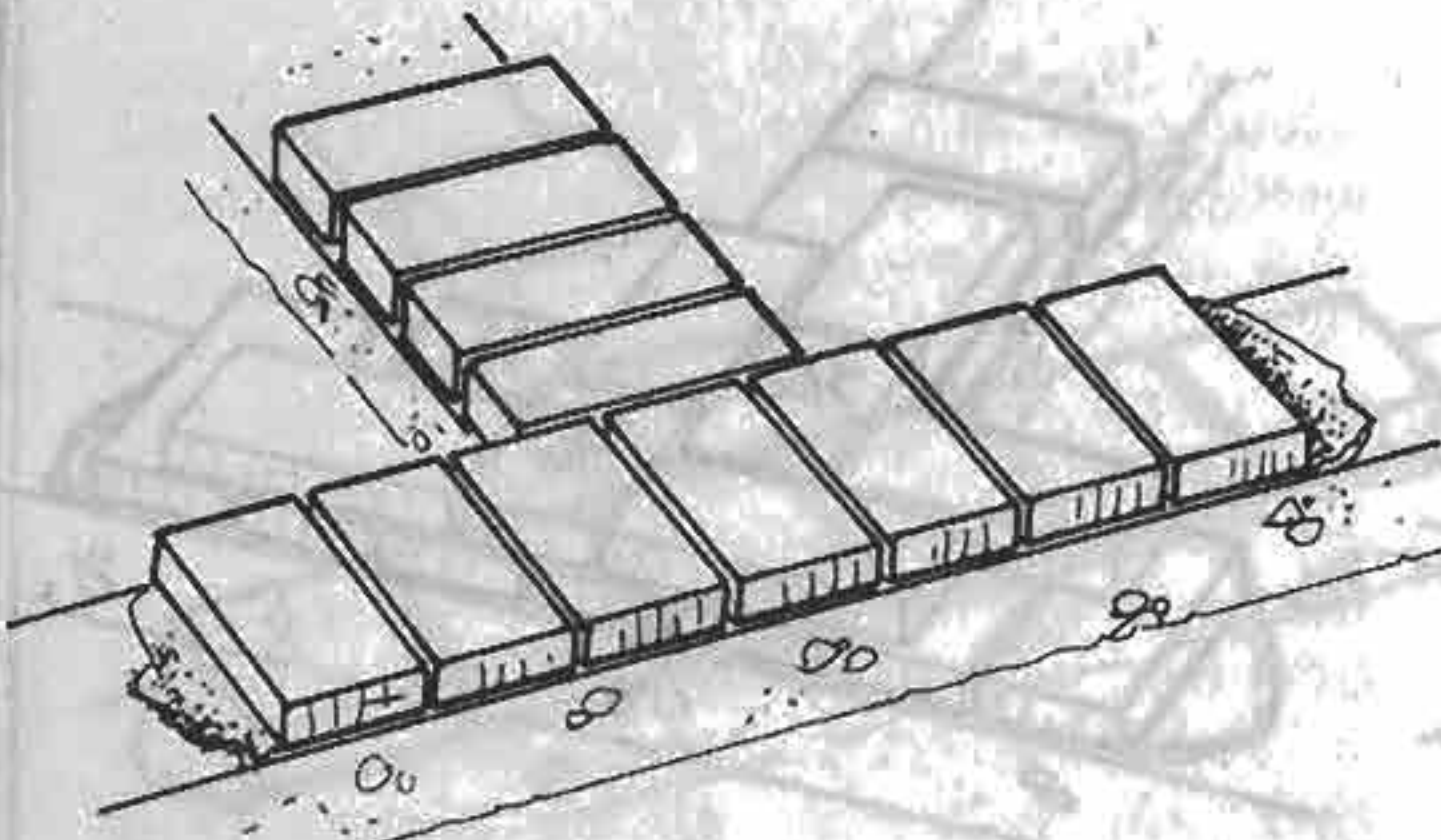
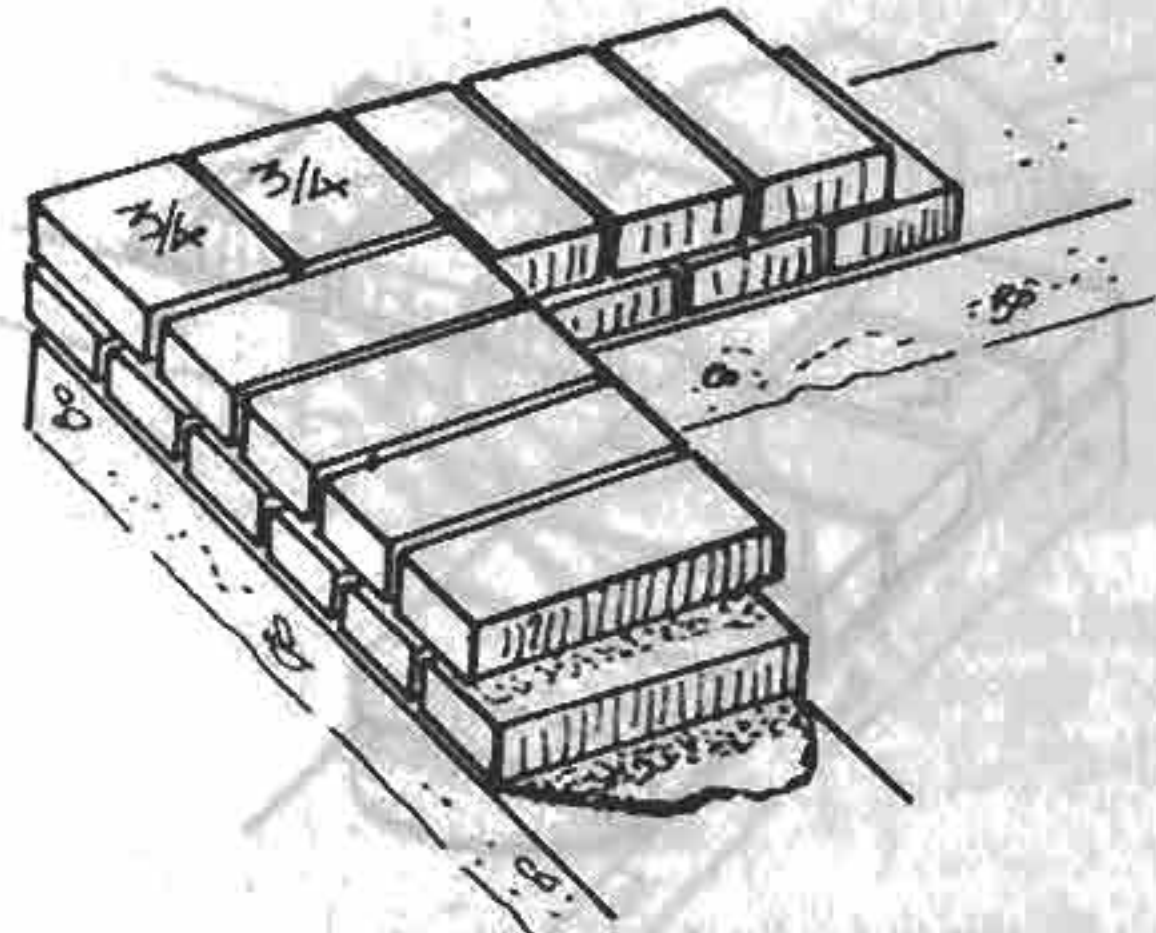
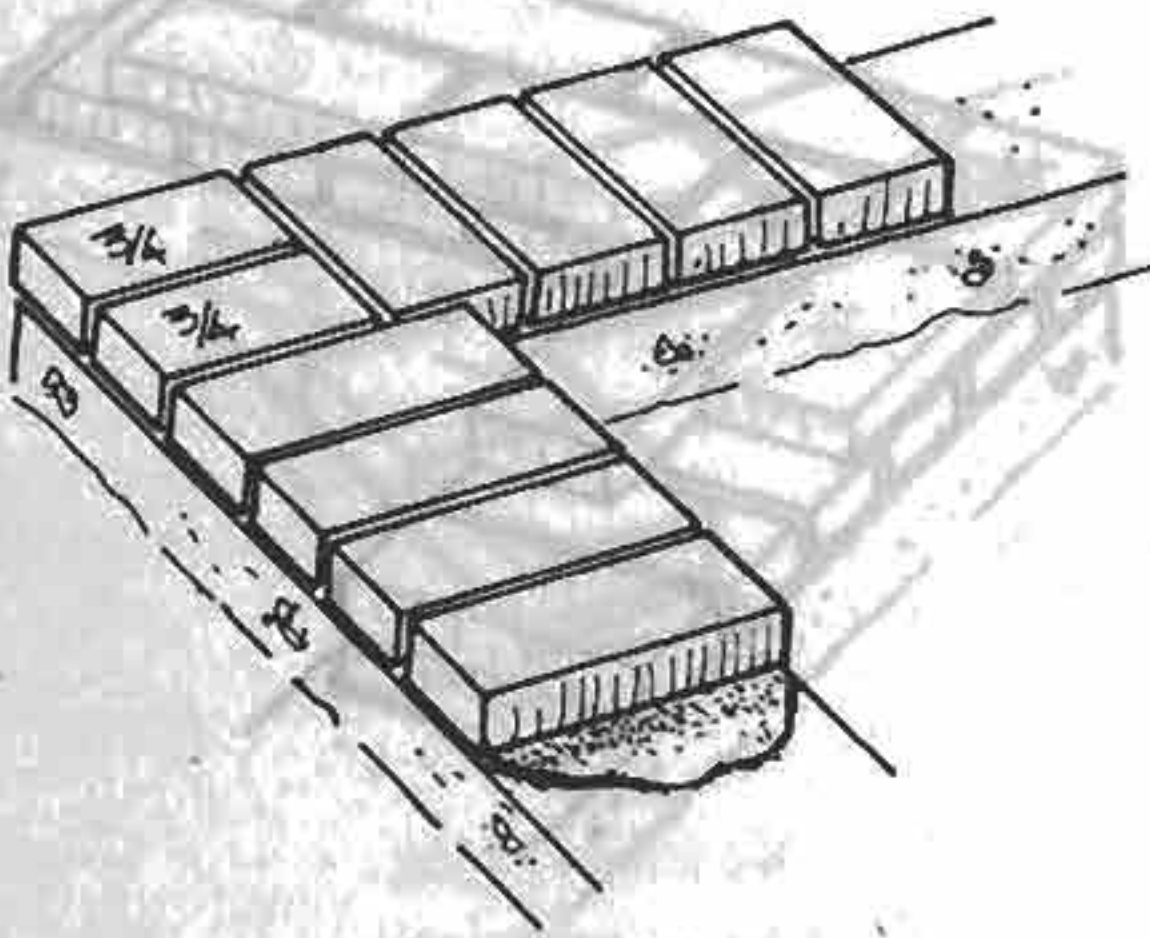
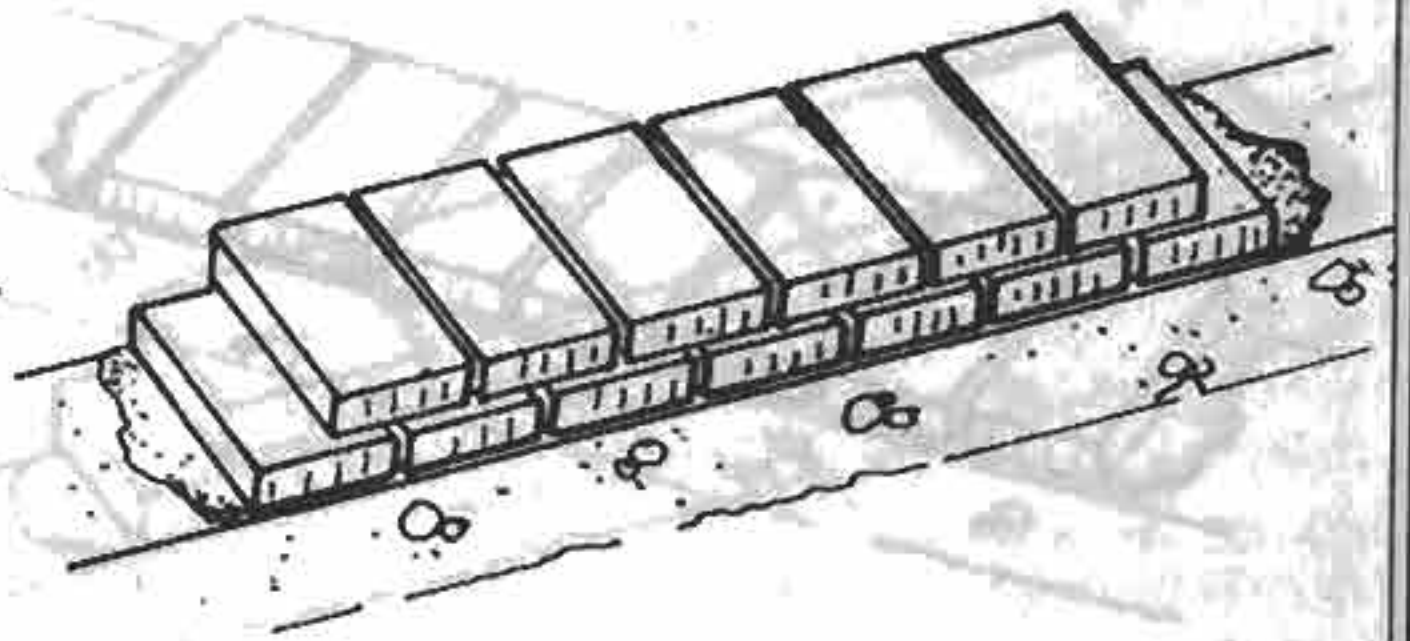
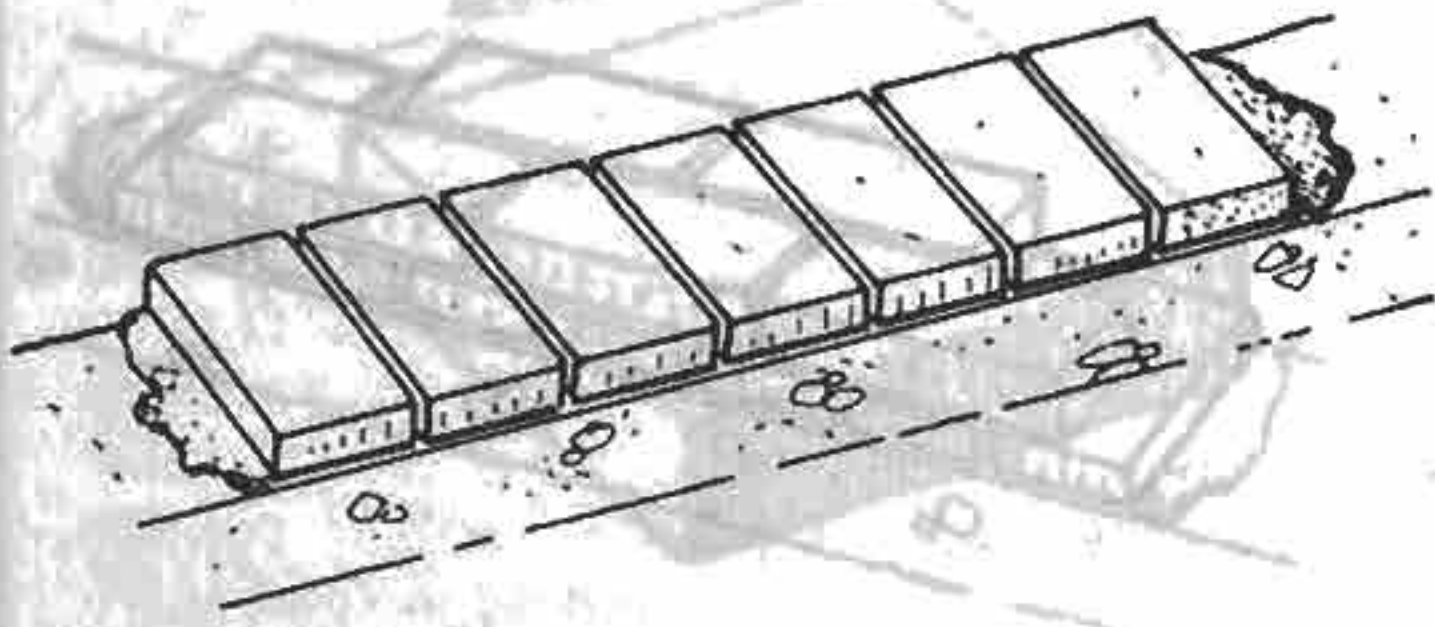

BRICKWORKING

FIGURE 181: BONDING PATTERNS FOR RECTANGULAR BRICKS.

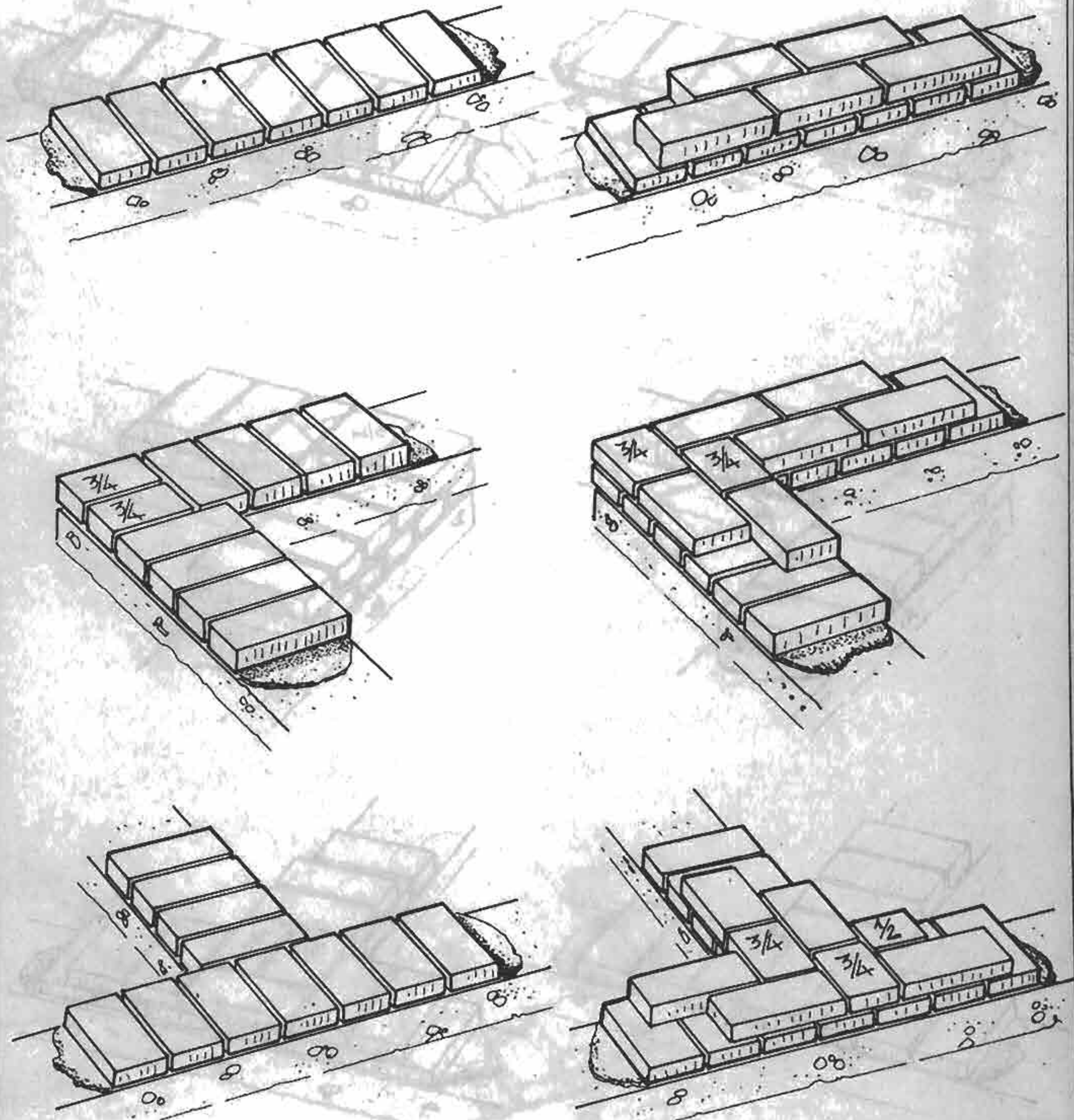
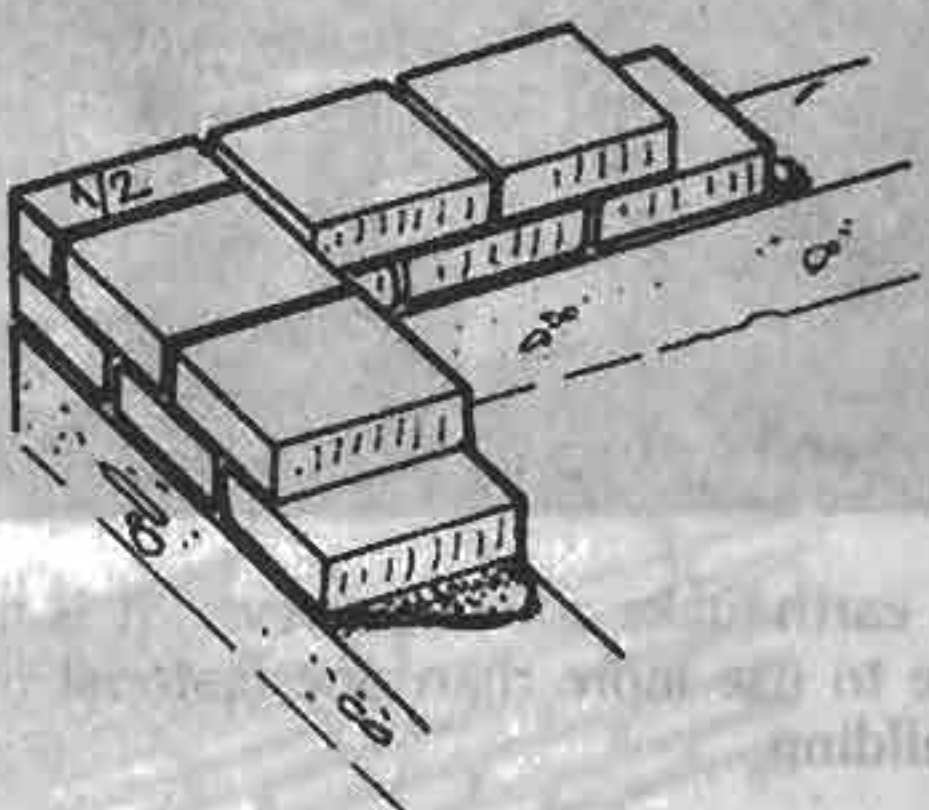
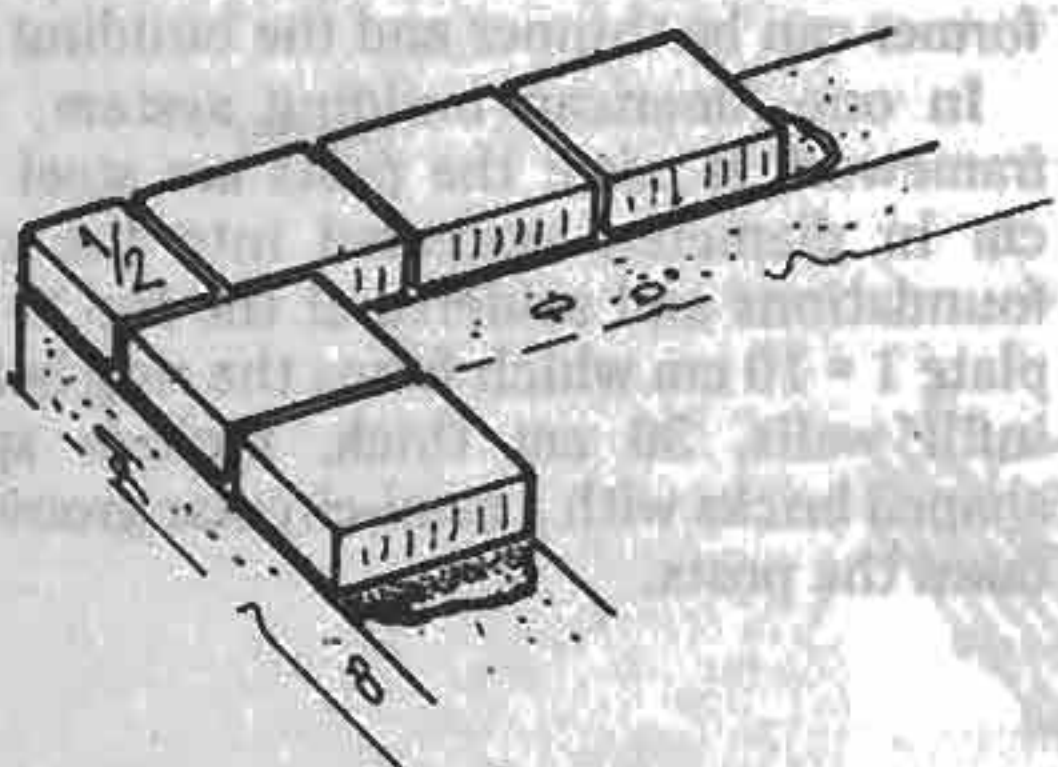
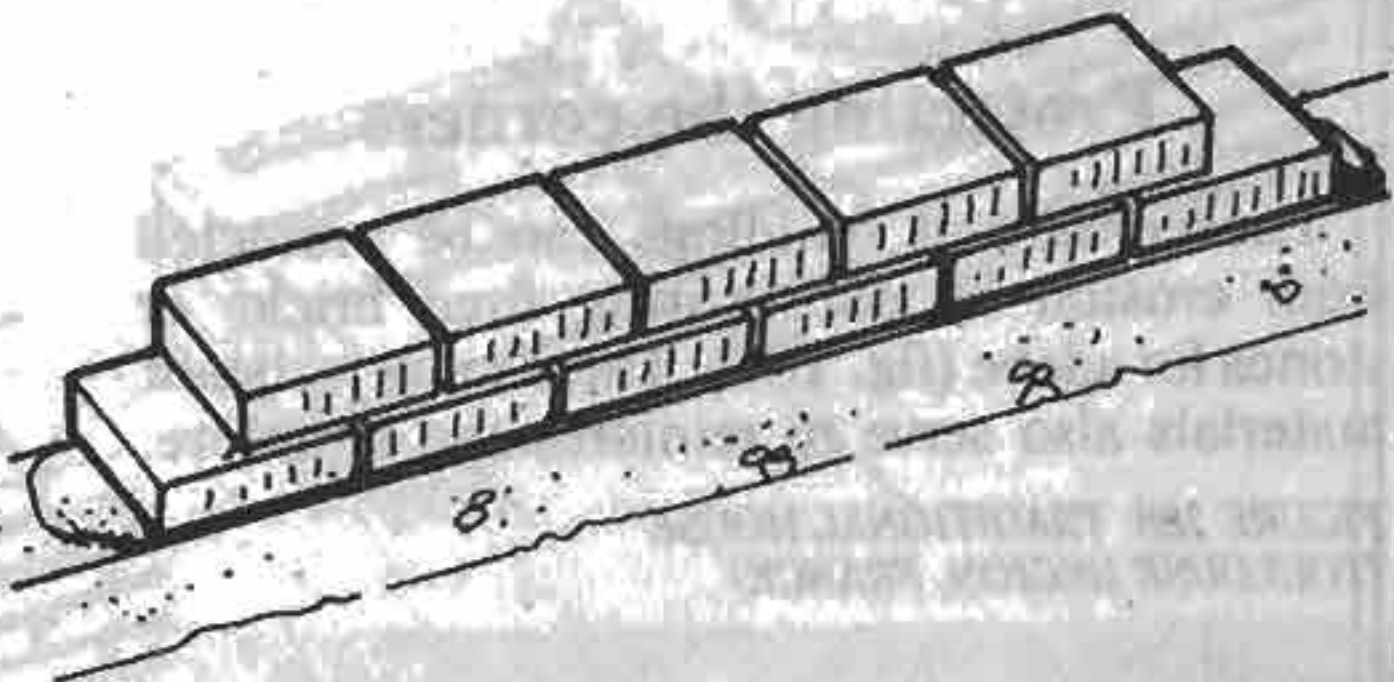
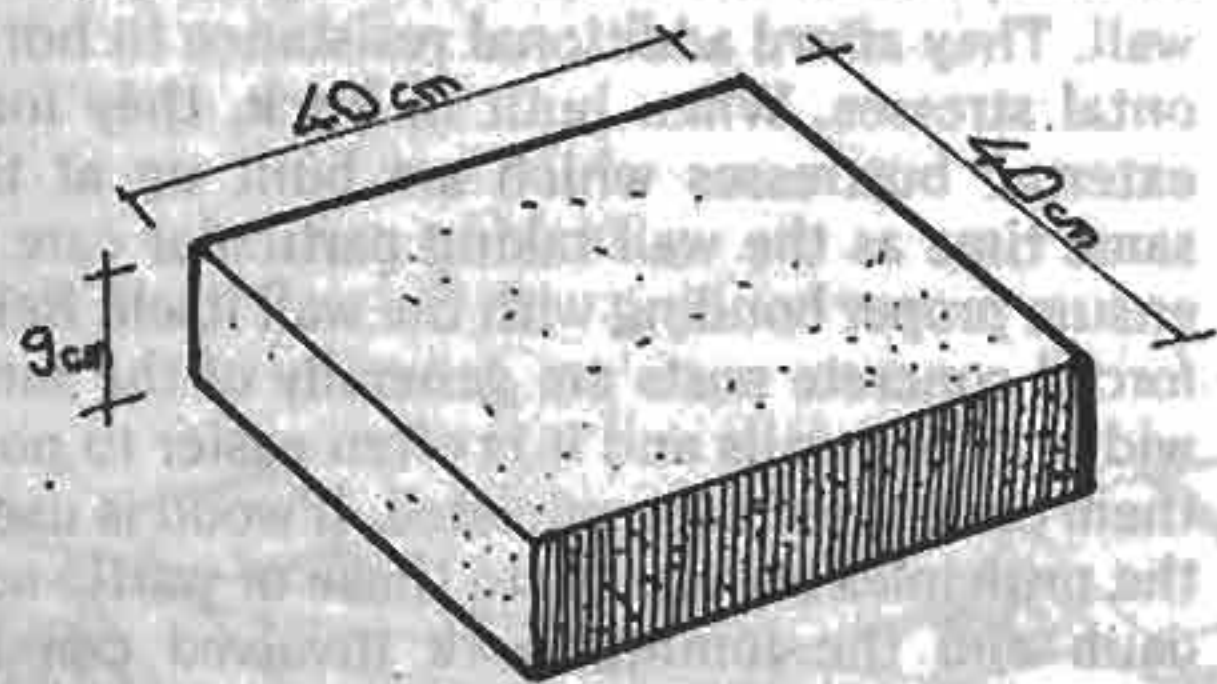

FIGURE 182: BONDING PATTERNS FOR SQUARE BRICKS.

is a brick for which the mortar is made of reinforced concrete. It can be anchored into the wall by pouring small concrete supports in the corners when these are in the brickwork course. The pattern is then held in the masonry with bolts.

Point. These link the foundations to the beams and comprise the timbers of the house. They are placed at the most vulnerable points, corners, and in the middle of long stretches of wall. They are placed at the middle of long stretches of wall.



Reinforcing the masonry:

Reinforcing the structure

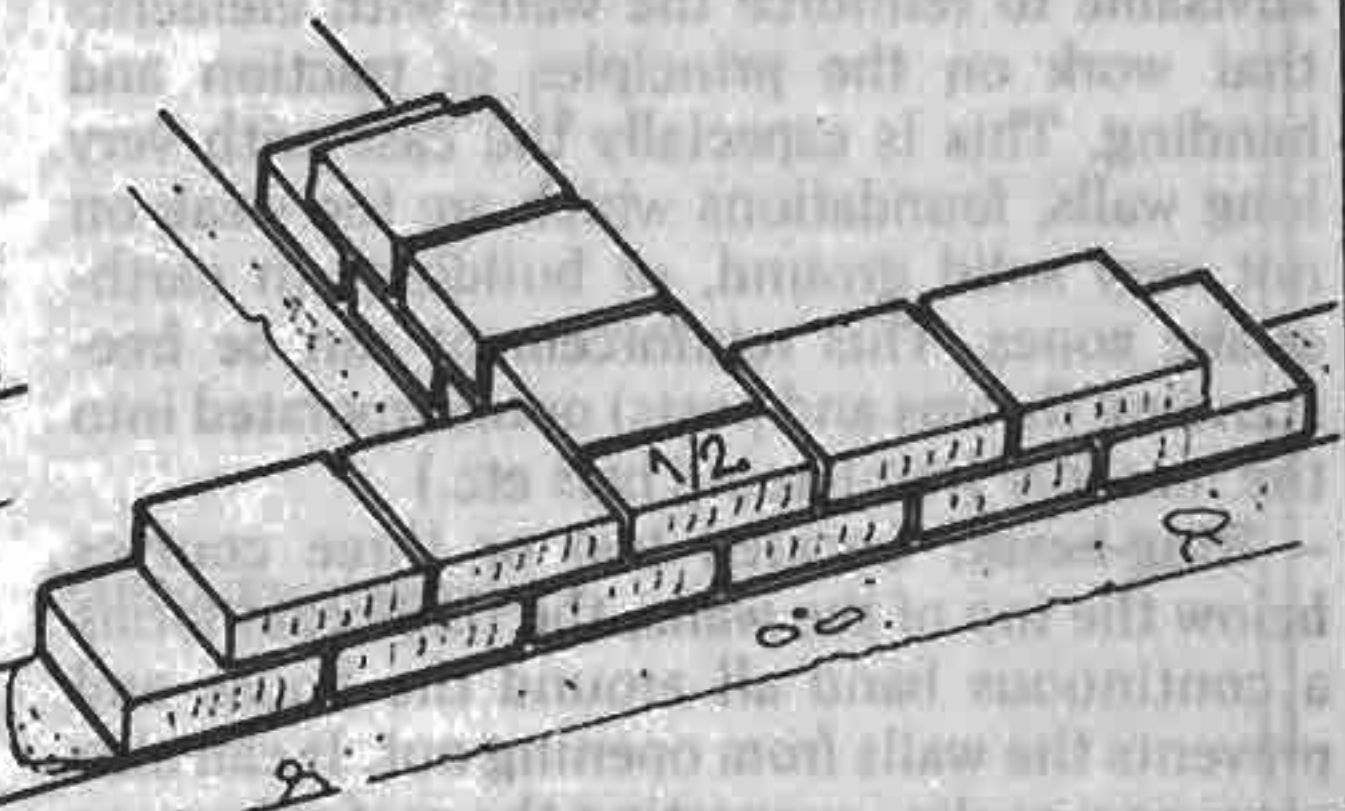
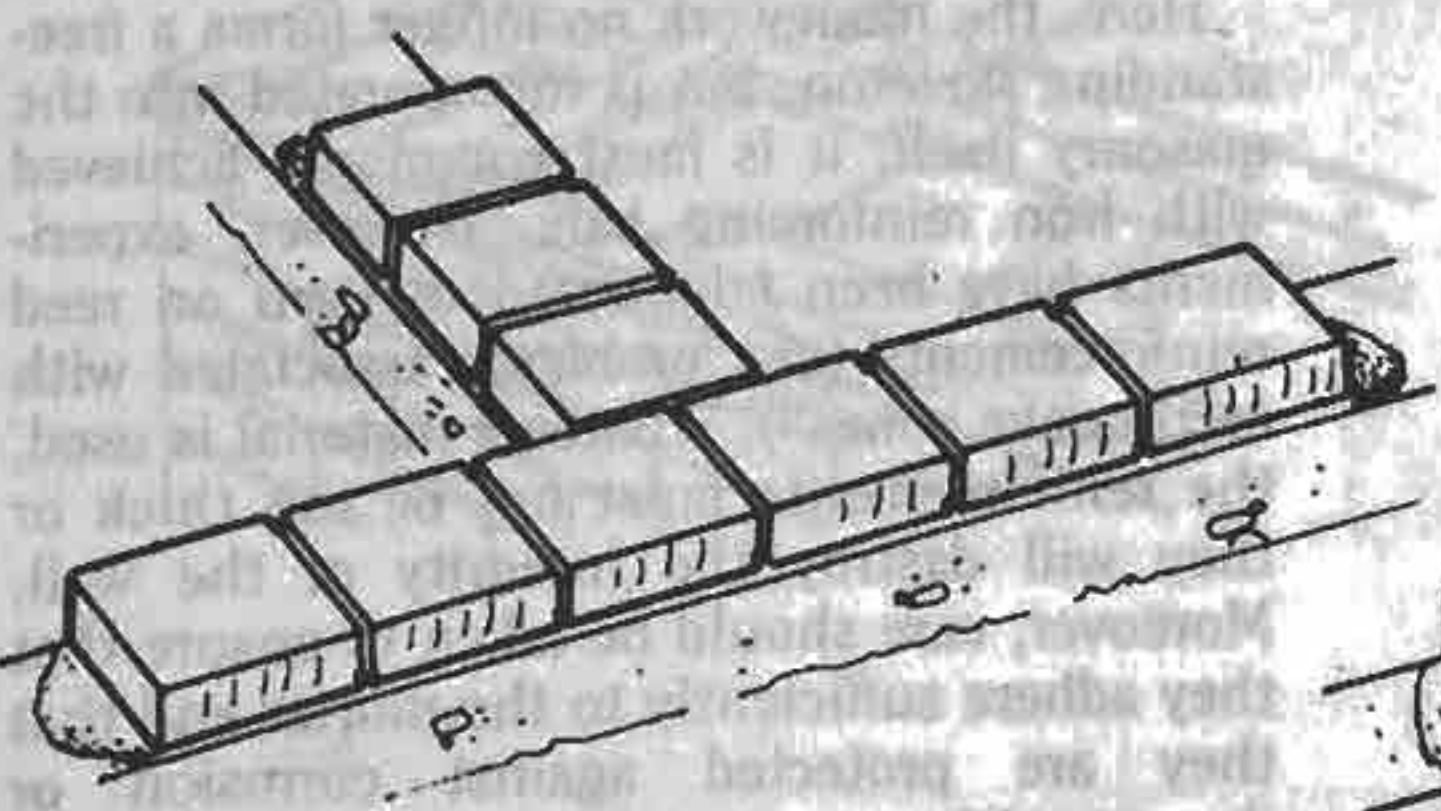
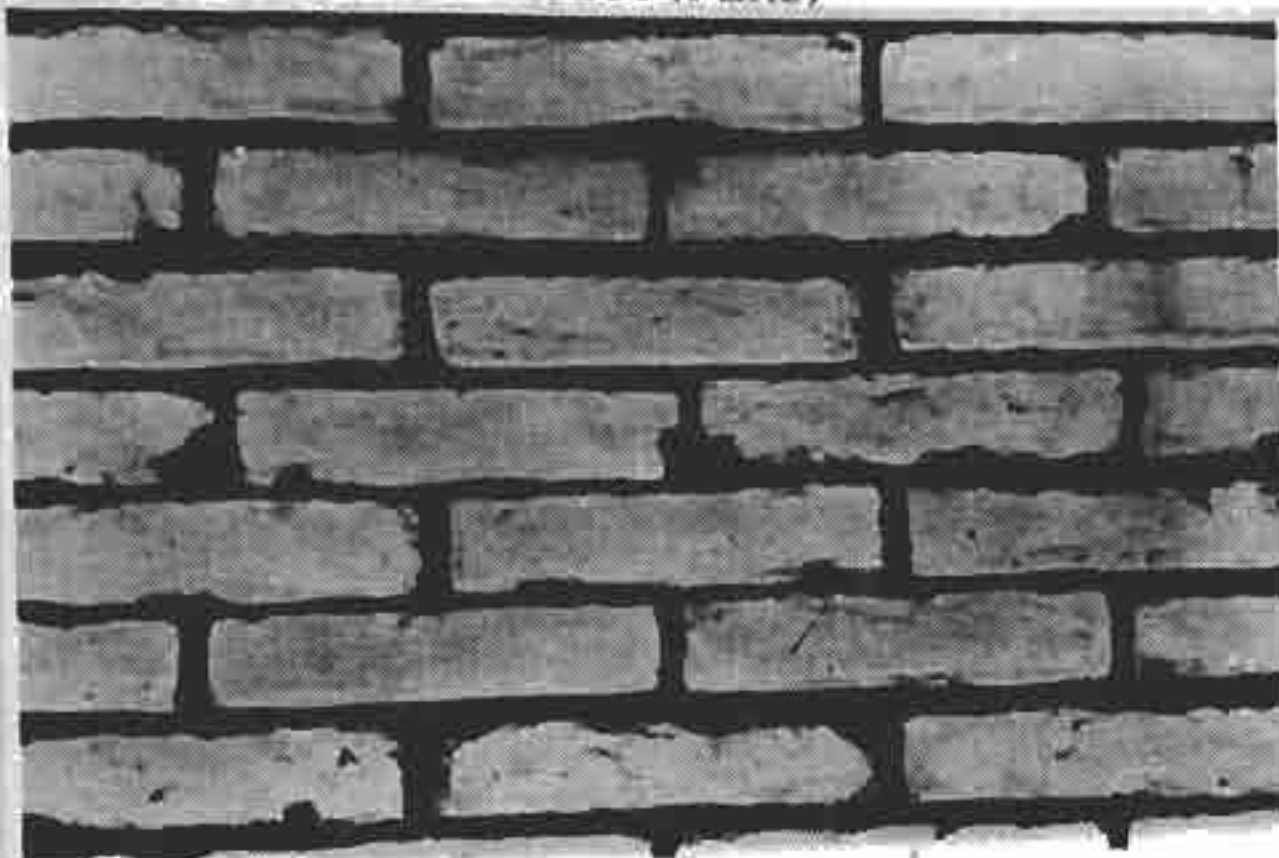

FIGURE 184: BONDING OF STABILIZED BRICKS,
CAYALTI PROJECT (PERU)



Oficina Nacional de Desarrollo Comunal - Pérou

Protecting the corners

The corners of buildings can be protected from erosion by substituting fired bricks or stones for adobe (fig. 188). These more resistant materials also serve to reinforce the structure.

FIGURE 188: TRADITIONAL HOUSE
(TOULOUSE REGION, FRANCE)



CRA Terre

In earthquake zones, however, it is not advisable to use more than one material in any one building.

Reinforcing the structure

Apart from ring-beams and foundations, which are indispensable in all cases, it is often advisable to reinforce the walls with elements that work on the principles of traction and bending. This is especially the case with very long walls, foundations which are too weak on not very solid ground, or buildings in earthquake zones. This reinforcement can be free-standing (beams and posts) or incorporated into the masonry (reinforcing bars etc.)

- **Ring-beam:** Located two or three courses below the top of the walls, the ring-beam forms a continuous band all around the house and prevents the walls from opening out. It can also serve as a purlin, supporting the roof rafters, or

as a lintel for doors and windows. It is usually made of reinforced concrete, wood or a metal lattice (fig. 190). It can be anchored more firmly into the wall by pouring small concrete supports in the corners where these replace the last few brick courses. The ring-beam is then held in the masonry with bricks.

- **Posts:** These link the foundations to the ring-beam and complete the framework of the house. They are placed at the most vulnerable points: corners, and in the middle of long stretches of wall. They afford additional resistance to horizontal stresses. When built in brick, they form external buttresses which are built up at the same time as the wall taking particular care to ensure proper bonding with the wall itself. Reinforced concrete posts are generally of the same width as the walls and it is often easier to pour them once these are completed. If wood is used, the principles are similar to those of wattle and daub and the joining work involved can be extremely complex. One simple method is to place at corners and openings 20 cm square posts linked at top and bottom by stout planks. The spaces between them are then filled with a rough masonry infill of the same width as the posts. As much of the load normally placed on the walls is now taken up by the posts, the former can be thinner and the building lighter.

In one American building system, a metal framework is used: the posts are steel tubes 4 cm in diameter, anchored into the concrete foundations and soldered at the top to an iron plate 1 x 10 cm which forms the ring beam. The infill walls, 30 cm thick, include specially-shaped bricks with a semi-circular groove which takes the posts.

Reinforcing the masonry: reinforcing bars etc.

Here, the framework no longer forms a free-standing skeleton, but is incorporated into the masonry itself: it is most commonly achieved with iron reinforcing bars. However, experiments have been conducted in Peru on reed reinforcements (cf. "problems associated with earthquake zones"). Whatever material is used, the reinforcements must not be too thick or they will destroy the integrity of the wall. Moreover, care should be taken to ensure that they adhere sufficiently to the mortar and that they are protected against corrosion or decomposition.

FIGURE 190. DOUBLE INSULATED WALL. THE TWO WALLS ARE LAMINATED TOGETHER WITH INSULATION IN THE JOINTS.

An adobe house in a Peruvian community

FIGURE 190:
VARIOUS TYPES OF RING-BEAM

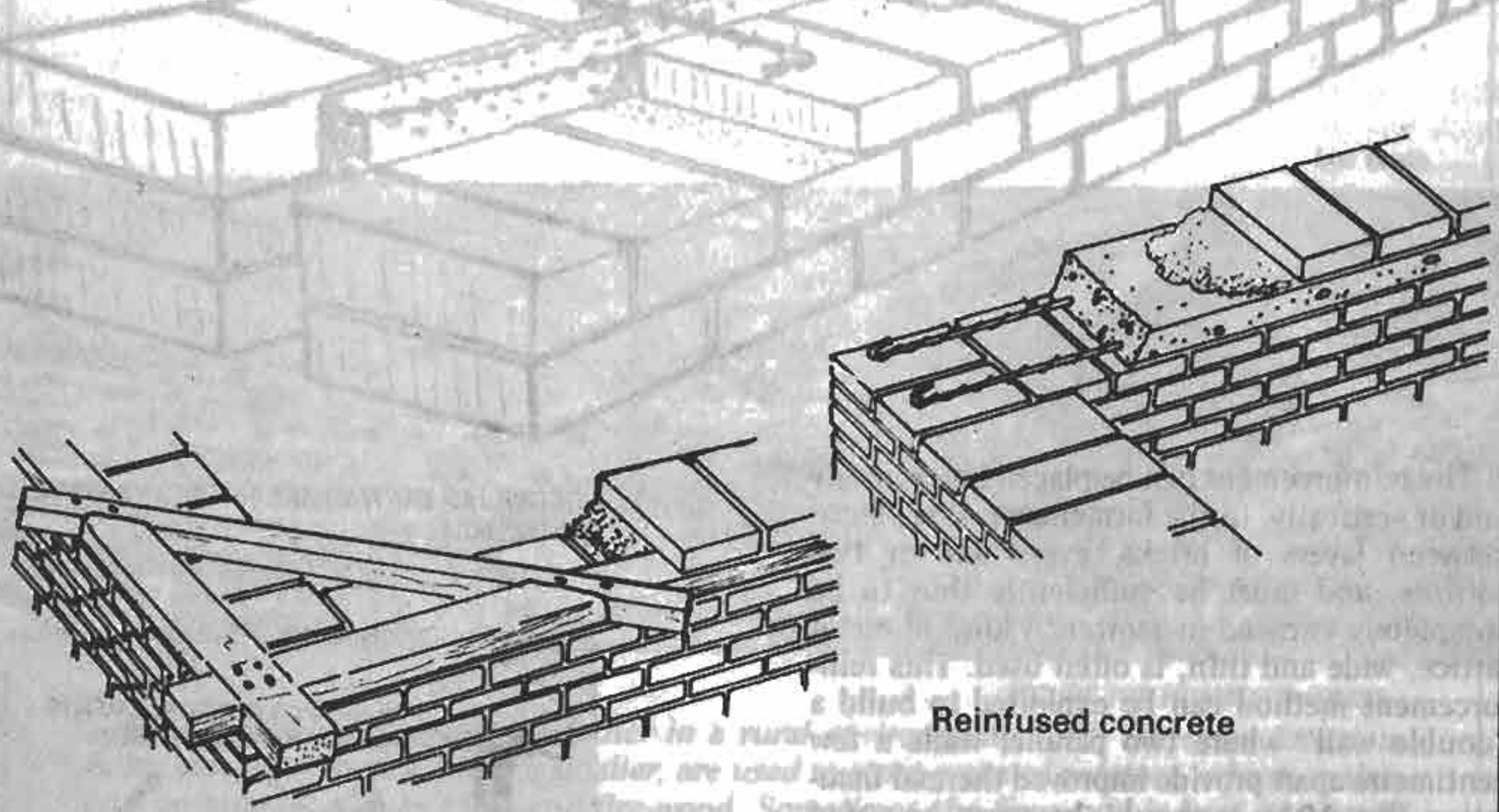

Wood

Reinfused concrete

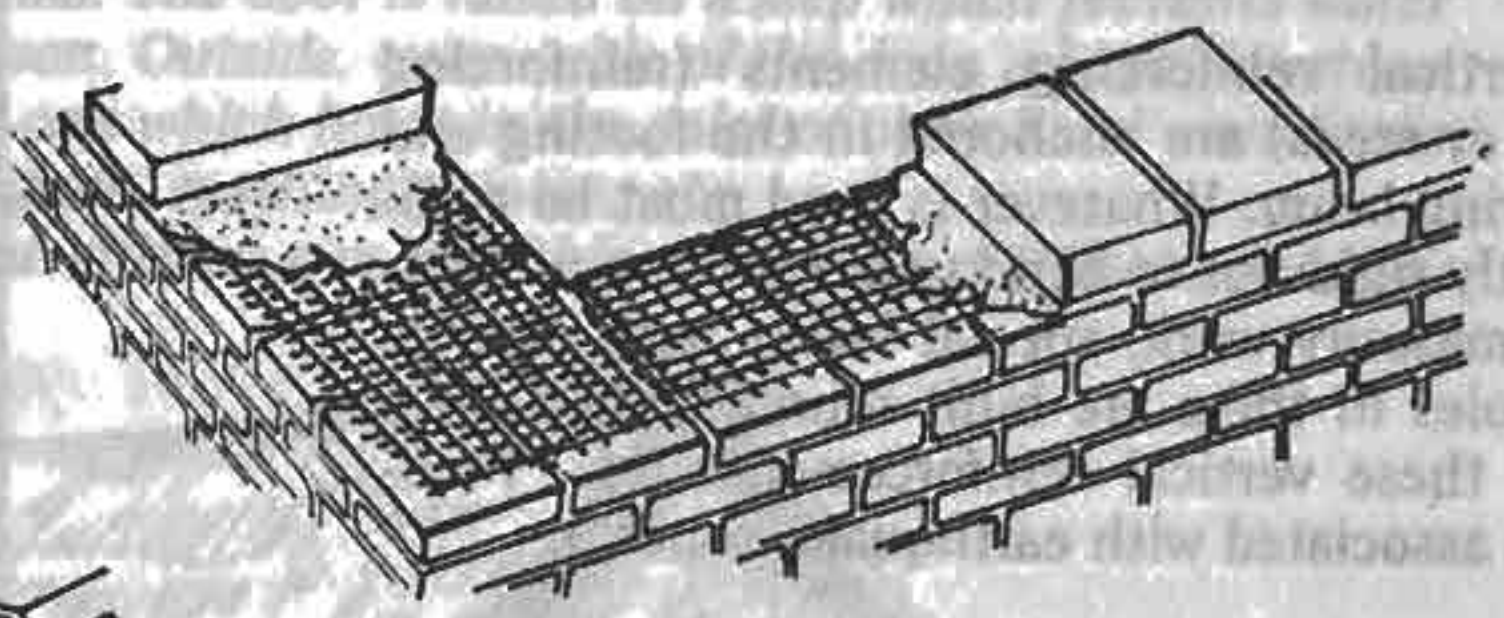

Treillis

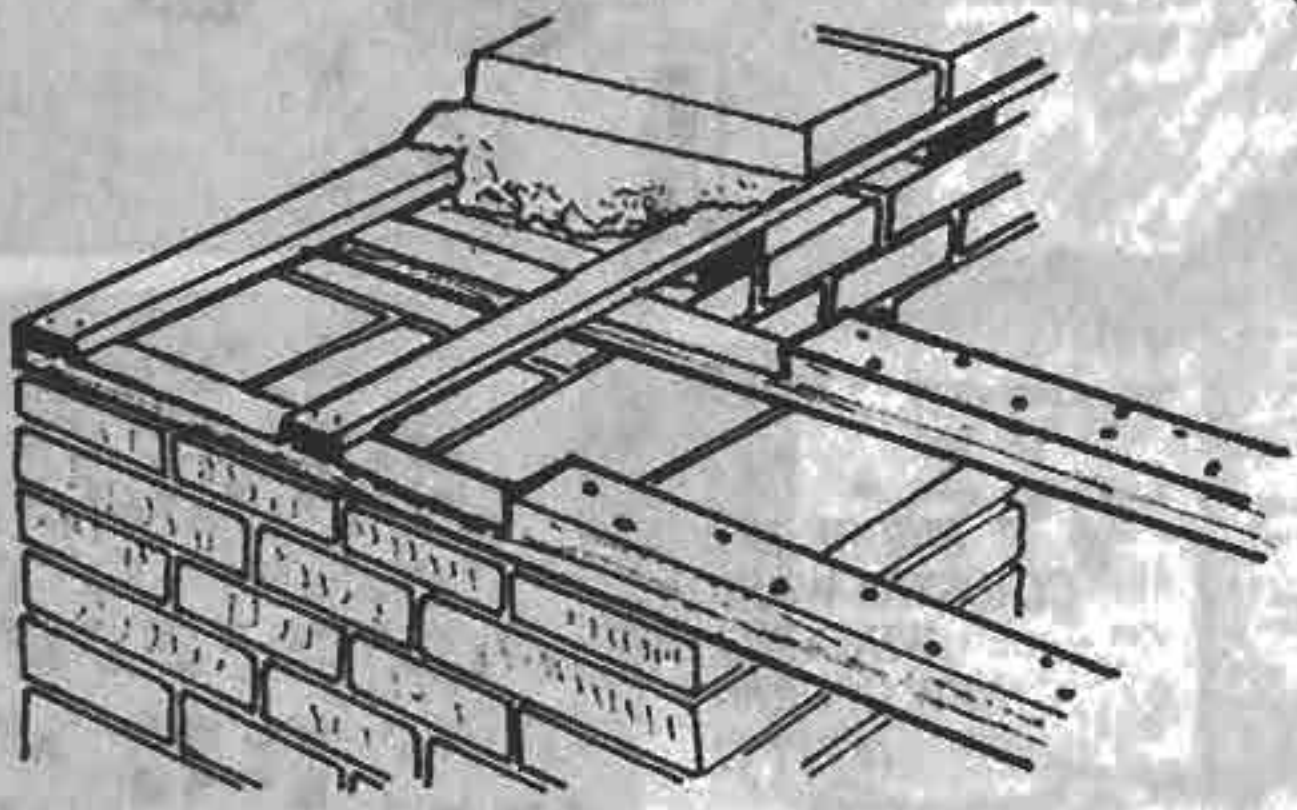

Nailed down planks

FIGURE 191: DOUBLE INSULATED WALL. THE TWO WALL PANELS ARE LINKED BY BARBED WIRE INSERTED IN THE JOINTS.

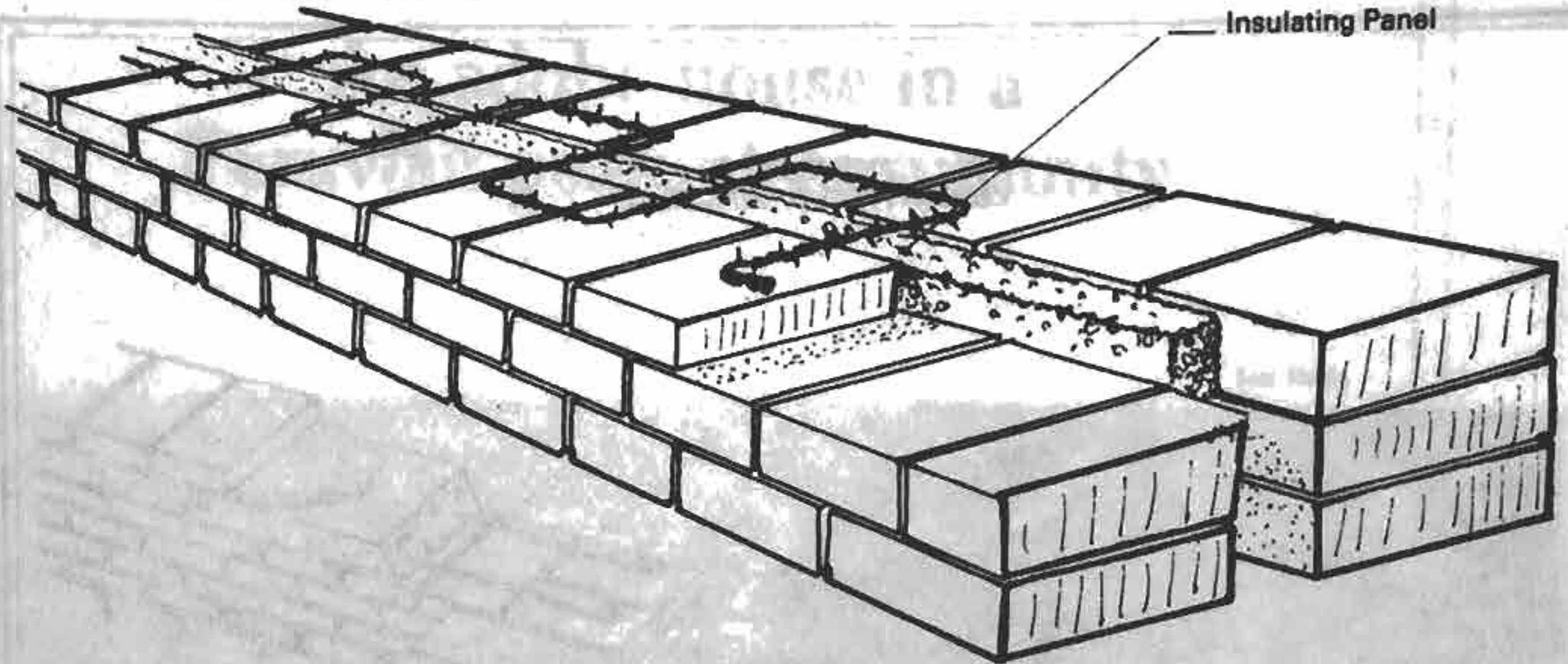

The reinforcement can be placed horizontally and or vertically. In the former case, it is placed between layers of bricks, every one or two courses, and must be sufficiently thin to be completely encased in mortar. A kind of metal lattice, wide and thin, is often used. This reinforcement method can be exploited to build a "double wall" where two parallel walls a few centimetre apart provide improved thermal insulation (fig. 191); it should, however, be noted that the brackets which usually link the two "panels" of such walls do not provide any reinforcement, since this must be continuous to be effective.

Vertical reinforcing elements (reinforcing bars or reeds) are anchored in the footing and the ring-beam. Whatever is used must be sufficiently rigid not to bend under its own weight. For masonry work, special bricks with indents or holes in them are built round or slid down over these vertical reinforcements (cf. "Problems associated with earthquake zones").

Openings

If wooden or reinforced concrete lintels are used, they must project at least 20 cm either side into the brickwork (50 cm in earthquake zones). Arched openings are easy to realise in brickwork; while they are being built, they can be supported by a brick or earth infill, or by a special form; the latter should be placed on small heaps of sand or on wedges, to facilitate its removal.

FIGURE 192: EARTHQUAKE-RESISTANT STRUCTURE, GUATEMALA.



FIGURE 195: CLAUSTRAL WORK WINDOWS, NEW GOURNA (EGYPT)

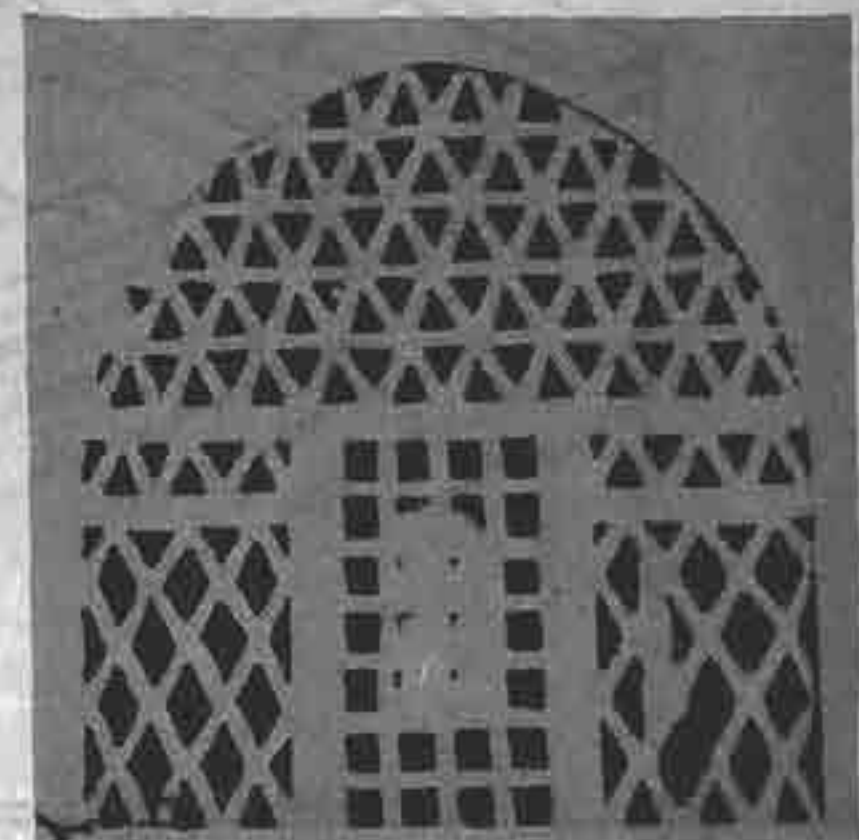

Earthquake-resistant buildings

An adobe house in a Peruvian peasant community

Luc Bazin



FIGURE 197: HUANCAYO (PERU).

Not all buildings grouped together in a rural environment fulfill the same function. Some provide housing, others, smaller, are used to store crops of potatoes, wheat, maize, and quinoa, as well as tools and fire-wood. Sometimes the fire-wood is kept in a small lean-to shed next to the house (fig. 198). The ridged roof, thatched with grass, (the species *Ichu Festuca*, which grows "dry" in small tufts on the upper plains) is characteristic of the adobe house. Windows are almost never found, apart from a small opening high up in the gable-end. Access to the single-room accommodation is through one door, crudely assembled from rough planks. The door is raised on a step which prevents water from entering during the rainy season. Outside, to one side of the door, a large flat stone (approx. 60 cm) and a small round one which holds in the palm of one's hand constitute the cooking utensils for pounding grain, mashing potatoes etc.

On the wall hangs lama meat or mutton cut into thin salted slices ("charqui") (fig.



FIGURE 198: PEASANT HOUSE (PERU)



FIGURE 199: INTERIOR OF PEASANT HOUSE,
PUNO (PERU).

199); it is startlingly dark inside: the only light penetrates through the doorway. The little opening in the gable-end gives only a feeble ray of light which is lost in the rafters... The smell of charcoal from the remaining smoke blends with that of earth.

The floor is of beaten earth and seems a mere extension of the walls which, left untreated, are of the same shade.

In one corner is the fire-place. The earthenware cooking pot rests on two or three big stones. Wood is thriftily used and kept dry amongst the rafters. The fireplace serves both for cooking and for heating the room.

The smoke filters out through the roof and cooking inside the house helps prolong the life of the Ichu thatch.

On the ground near the fire, the few pots and pans are propped against the wall. Opposite, on the other side of the room, the bed, covered with sheep-skins and blankets, takes up the whole width of the wall.

The ponchos and skins which will serve as bedding (on the ground) hang from the rafters. Guinea-pigs (edible), bred for food and allowed to roam the house freely, scurry under the bed.

Clothes and personal belongings in cloth bundles are littered here and there on the floor.

Above the wooden lintel of the door, a cactus, of religious and superstitious significance, hangs on a nail as a lucky charm...

The family structure comprises father, mother, children, grandparents, and extends to uncles, cousins etc. The family sleeps either all in the same room or in the small adjoining rooms. Twice a day the whole household assembles for meals, at sunrise and sunset; (often the meal will consist of a plain soup, thickened with potatoes, and tea with grilled maize.) The peasant will spend his whole day outside, taking with him a little bag containing grilled maize and "coca".

The whole family works in the fields, children and infants slung on their mother's back, others watching the sheep... The house remains almost deserted. Everyone has to help with sowing and harvesting. At other times, tasks are slightly more specialized: some will take the opportunity to maintain or put up buildings, others to weave ponchos and the "tocuyo" (woven wool) etc., and still others to make pottery, or wooden spoons which can be sold at the market and bring in a few extra soles.

When the animals are being moved from one pasture to another, or when the farming land is too far from the house, the peasant builds himself a kind of temporary hut with shrubs, Ichu grass and bits of plastic if he has any... He will use this hut as a refuge for the night and to shelter from the rain. They are also to be found built of stone with a thatch covering.

The peasant economy revolves around the cultivation of the land and all secondary activities are closely linked to this one.

Thus building is also linked to agricultural life, both with regard to the very organisation of the site and to the most favourable times of year for construction work. Thus for example adobe brick production and use tends to occur after the dry season harvests (from June to September). Putting on a thatched roof, as well as maintaining one, has to be done before the rainy season...

Earthquakes and adobe buildings

Seismic activity is a particularly devastating phenomenon; in Peru, for example, the earthquake of 31 May 1970 killed more than 40,000 people. Many areas of predominantly adobe building were badly affected. At Coisho, however, 40 km from the earthquake epicentre and on rocky terrain, damage was minimal and many adobe buildings withstood the effect of the earthquake and are still inhabited. This shows that under certain conditions sun-dried brick constructions can behave acceptably in an earthquake.

What are the factors determining the ability of a building to withstand seismic activity? Studies have shed some light on this problem. But first what exactly is an earthquake?

The earth's crust is divided into large plates or rigid sheets of rock, some of them under oceans and some under entire continents, (the Pacific shelf, the African shelf, the Antarctic shelf, etc.). Wherever two plates meet, earthquakes can occur on the surface, as they are continually shifting (a few centimetres a year) and colliding. This results in a number of phen-

omena. The plates overlap or come into contact tangentially. For many years they pull in opposite directions without creating any movement on the earth's surface. This contact causes enormous pressures to build up from one year to the next. Sooner or later the most vulnerable points will no longer be able to withstand these pressures. When that happens, the plates will suddenly start shifting and produce an earthquake.

Shock-waves are thus transmitted to the ground and the resulting phenomenon can be schematically represented as two main types of motion, which can moreover occur simultaneously.

a) **Lateral motion:** the earth moves (the impression is of being pulled and pushed), which in construction terms means that the foundation moves while the rest of the building - through inertia - is left behind.

b) **Undulatory motion:** (a pitching sensation). In building terms this can lift the building up. During an earthquake the design of a wall will affect the way it behaves (fig. 201).

Factors likely to lead to building damage during an earthquake, ref. 43

1) The site for the building has been badly chosen: a poor location (uneven terrain, inadequate drainage...), a soil which has too much clay or too much sand (leading to liquifaction). The ground to be built on should have a compressive strength of 2 kg/cm² for non-stabilized adobe and 1 kg/cm² for stabilized adobe. A minimum 5 cm gap should be left between adjoining houses.

2) The building is of the wrong size or shape:
- if it has more than one storey (its overall height exceeds 3 m);
- if its proportions are wrong (too long or too high a house...);
- in general, if it is L-shaped.

3) The proportions of the wall are incorrect, notably if the ratio of height to width is too great. (As stated above, the ideal proportions are width = 1: length = 12: height = 8.)

4) The materials used for building the walls are carelessly mixed ("hammer" effect between two types of material).

5) The adobe bricks have been badly produced (use of poor earth, little care taken during the moulding process...)

6) The brick dimensions are incorrect. Studies have allowed calculations demonstrating that square-shaped bricks afford better earthquake-resistance.

FIGURE 201: EFFECT OF EARTHQUAKE ON A WALL

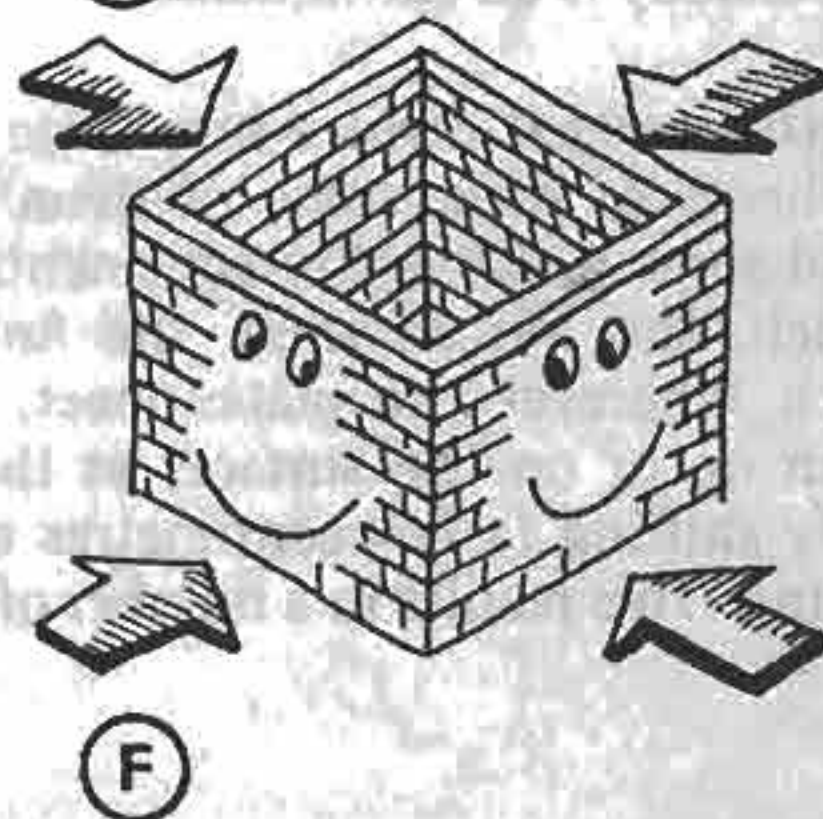
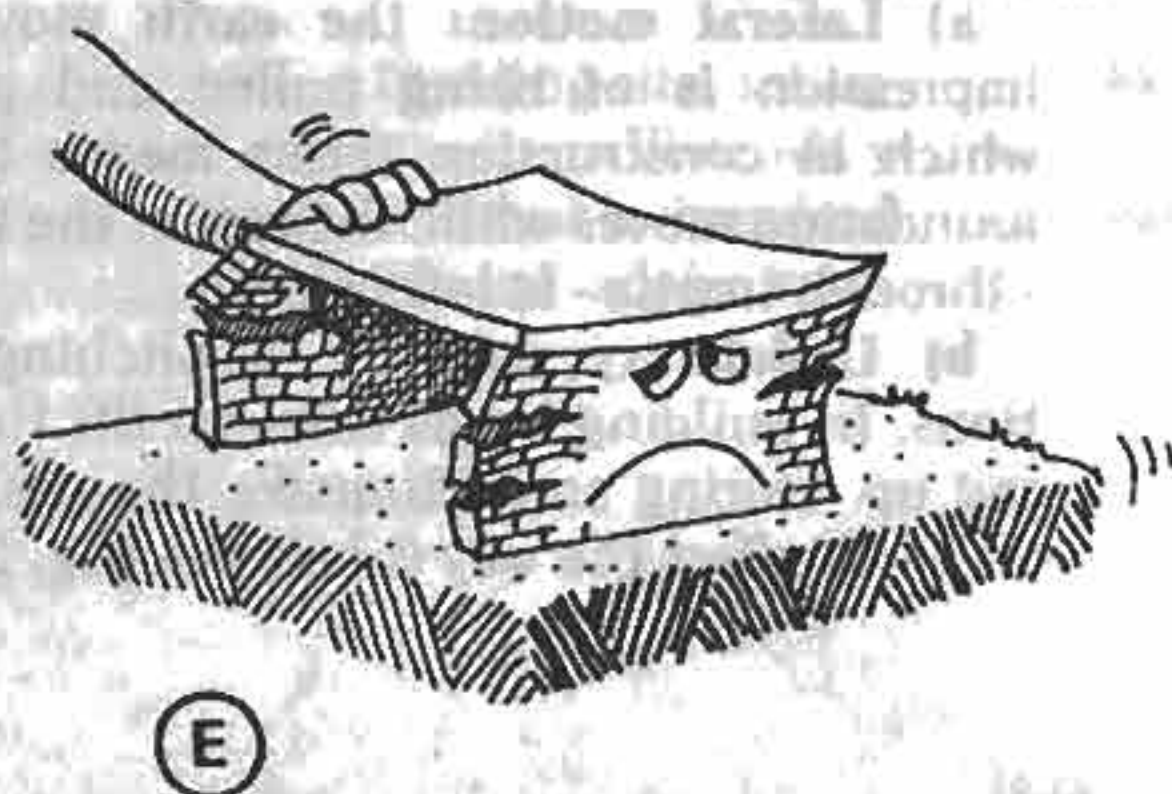
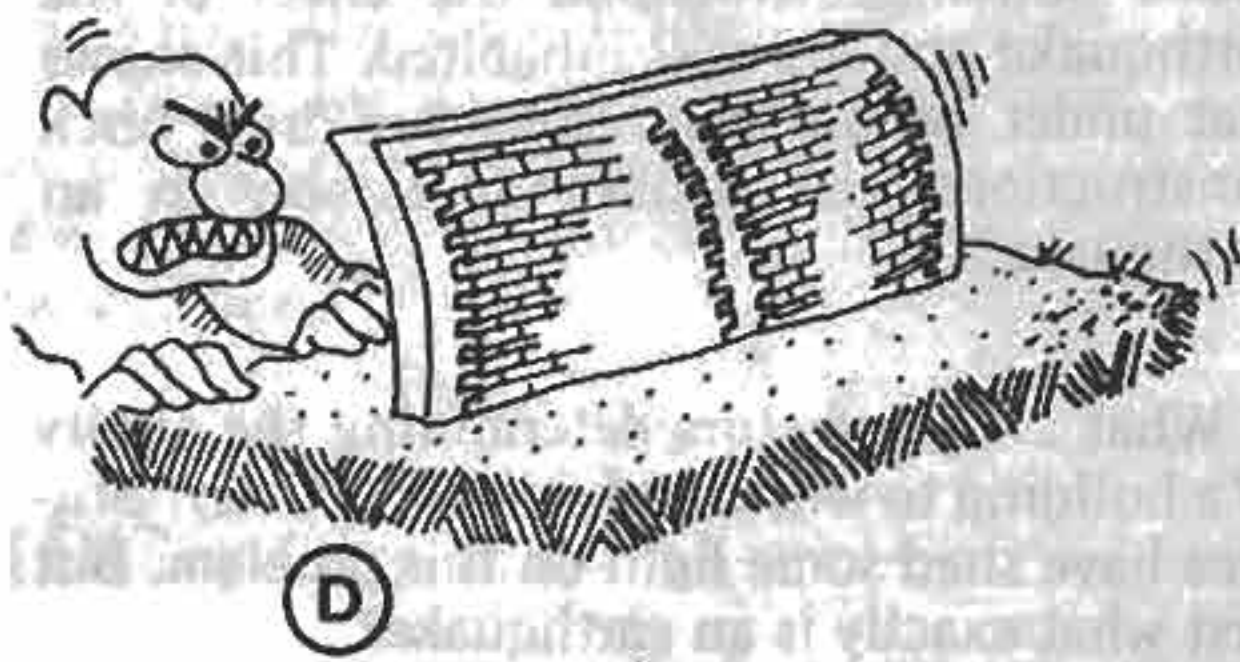
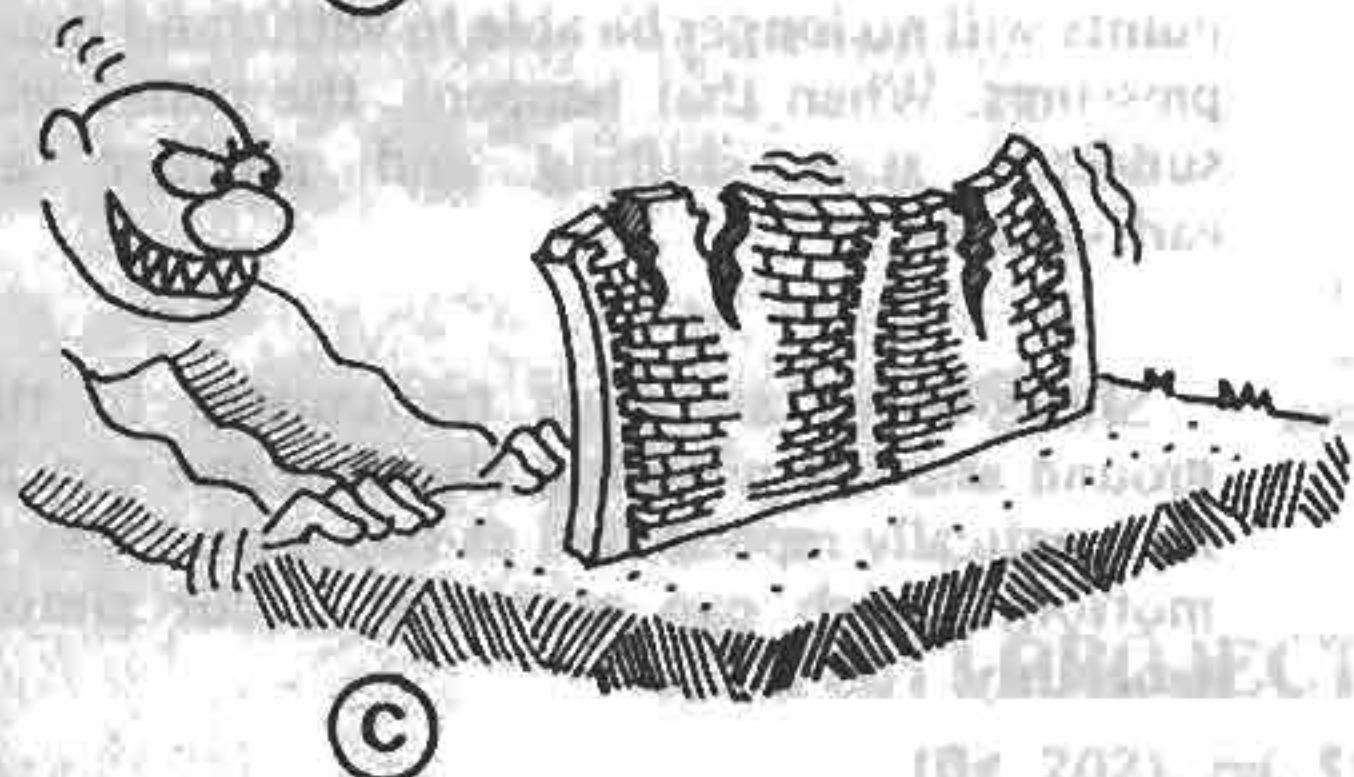
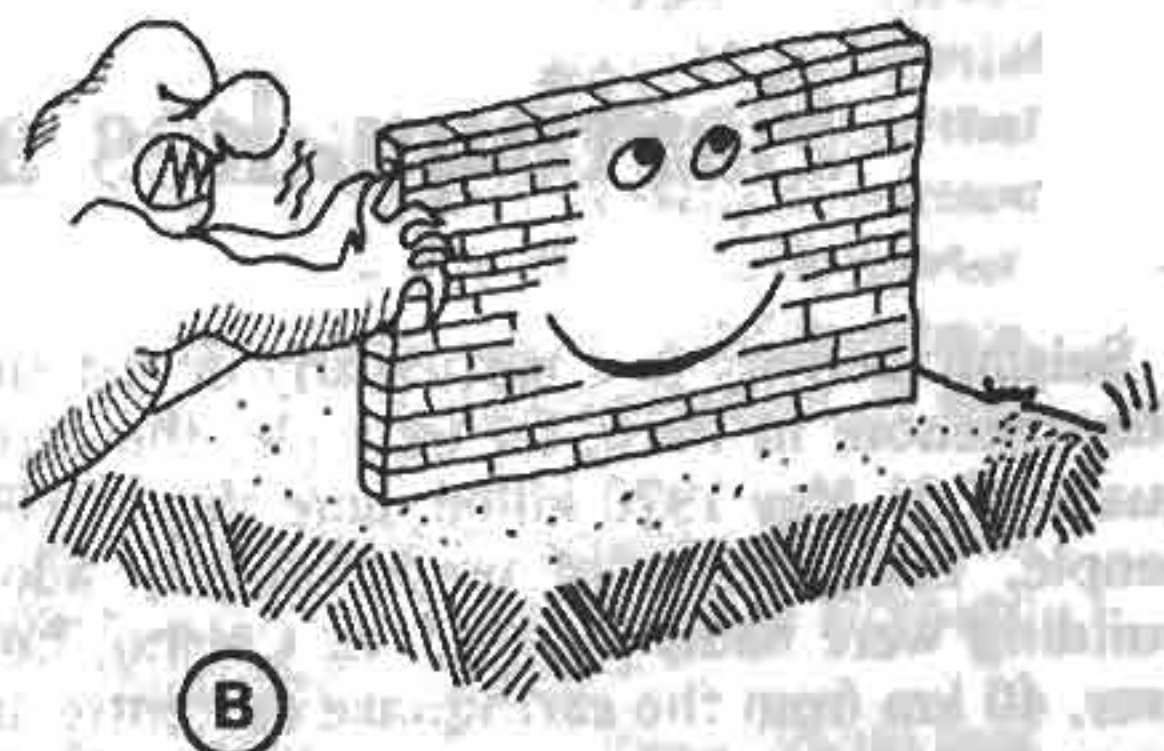

A - A WALL ALONE WITHOUT POSTS OR RING-BEAM CANNOT RESIST THE TREMOR.
 B - LENGTH-WISE RESISTANCE WILL BE BETTER.
 C - VERTICAL REINFORCEMENTS WILL IMPROVE RESISTANCE, BUT FAR FROM ENOUGH.

D - A RING-BEAM WILL IMPROVE RESISTANCE FURTHER.
 E - TWO PARALLEL WALLS (WITHOUT BRACING) WILL COLLAPSE IF SUBJECTED TO TRANSVERSE PRESSURE.
 F - A "BOX" FORMED BY RIGHT-ANGLED RING-BEAMS WILL HAVE GREATER RESISTANCE.

The proportions of the brick are important, however, since it has been shown that a square brick $38 \times 38 \times 8$ cm will withstand seismic activity better than a rectangular brick $19 \times 40 \times 12$.

7) The bonding pattern is inadequate, particularly for the stretchers.

8) The mortar is too thinly laid between the various courses (less than 2 cm) or too thickly laid or the vertical joints are badly filled.

9) The openings are too large or too numerous, in any one wall the openings should not exceed one third of the total surface area. Openings will preferably be placed in the longest wall. They should not be less than 1 m from a corner. The lintels should not be too short, and should be anchored in the wall at least 50 cm

each side of the opening. Doors should open outwards.

10) The building has no ring-beam, and no horizontal or vertical reinforcements have been included.

11) The roof is too heavy or badly laid. The roof beams rest on a lintel. The roof weight should be equally spread over the ring-beam.

In earthquake zones, adobe walls must be reinforced. Various methods can be used (including those reviewed above). Particular attention is paid here to systems aiming to reinforce the masonry itself with reeds.

Research has been carried out in Peru on this kind of reinforcement to test the effect on demonstration walls of the stresses of compression, bending and splitting during an earthquake.

A) Compressive stress results in the right-angle walls at corners opening out. Some horizontal reinforcement is therefore required. A kind of "ring-beam" in the form of reeds must be added either in each layer of mortar or every two courses. A study by Vera Gutierrez (1972) suggests the following: for a rough-cast wall with an earth mortar (2.5 cm joint) -

1) an earth mortar with 15% cement used without reed reinforcement gives a compressive strength 2.5 times greater;

2) the use of an earth mortar + cement + "ring-beam" consisting in 2 reeds (caricillo) increases strength by five times;

3) the use of an earth mortar + cement + "ring-beam" consisting in 4 reeds increases strength by fifteen times.

B) Bending stress results in wall deformation. In 1971, Isabelle Moroni conducted an experiment designed to show the effect of a horizontal reed reinforcement (cana de guayaquil) and that of stabilizing the mortar with cement in relation to a rough-cast brick wall with an earth mortar.

1) use of earth mortar + horizontal reinforcement with two reeds, bending strength of wall increased four times;

2) use of earth mortar + cement + horizontal reinforcement with two reeds, bending strength of wall increased thirty-four times.

Following a series of trials, two official projects were carried out on an experimental basis in Peru. These were respectively:

- in 1975, the social housing project in Cayalti (Department of Lambayeque);
- and in 1976, the construction of a model rural coastal building in Lima.

CAYALTI PROJECT (1975)

(fig. 202), ref. 44

This was an experimental building site, set up on the initiative of the "Ministerio de Vivienda y Construcción". It comprised about a hundred social housing units in stabilized adobe rein-

forced with reeds.

The houses each had four rooms linked by a patio and a habitable area of 90 m².

The external and internal walls were built of

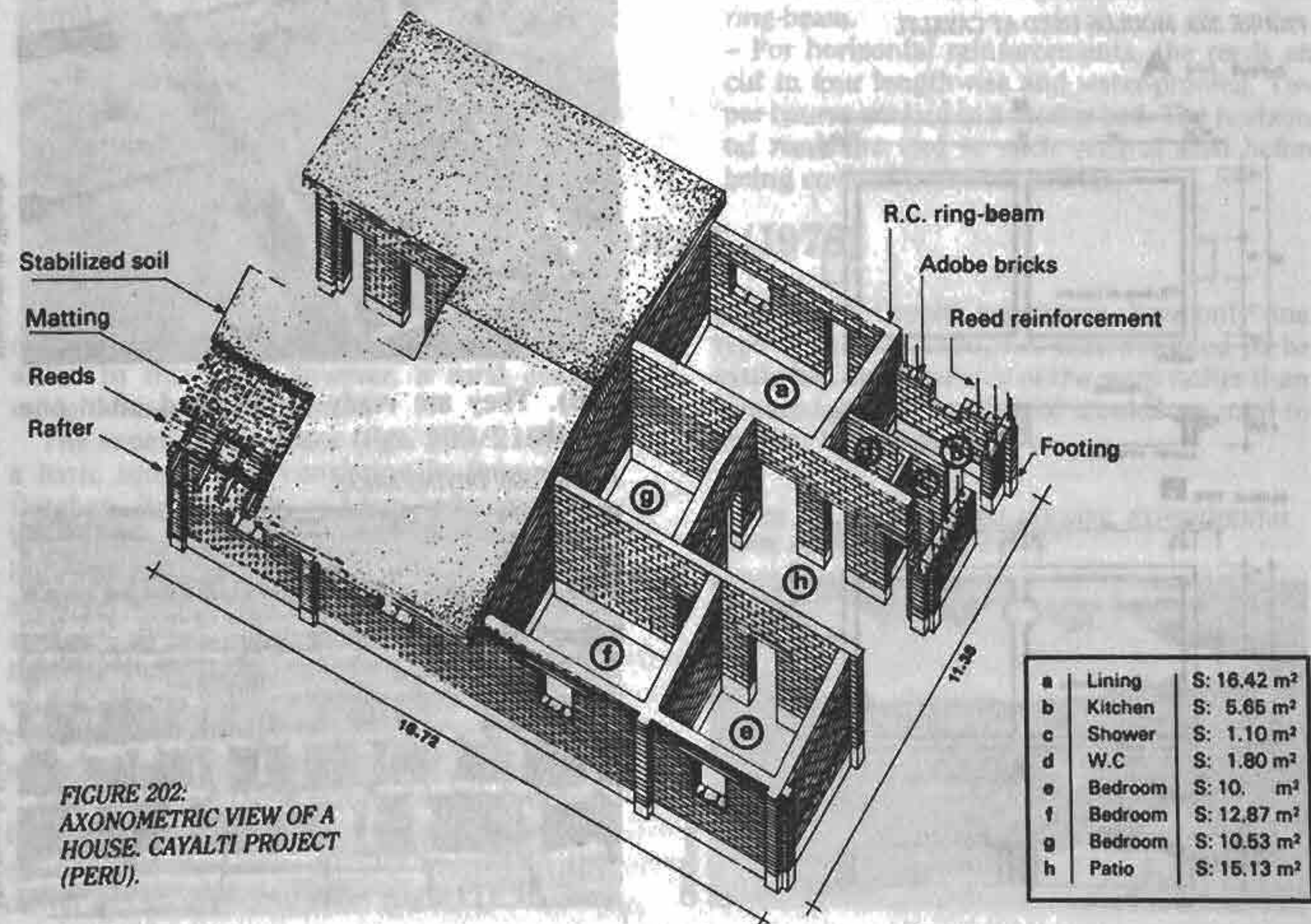

FIGURE 202:
AXONOMETRIC VIEW OF A
HOUSE. CAYALTI PROJECT
(PERU).

40 cm square adobe bricks. Their design and the bonding pattern used allowed for a vertical reinforcement with reeds through each brick and for a horizontal reinforcement in between courses.

The roofs were in stabilized earth, on a wooden framework covered with woven mats. (cf. "Roofs").

The cost of these units came to 3000 soles/m² (or 75 FF/m²) in 1975.

Brick production at Cayalti

The earth is mechanically excavated, sieved through a 5 mm mesh, stabilized with RC 250-type bitumen (Cutback RC2) which is stored in cement-lined wells covered over with tarpaulin (to ensure that it is adequately preserved for several months). This stabilizer is mixed into the earth at 2%. The mixing can be either mechanical or manual (with a shovel, a rake, or puddled with the feet). Once ready for use, the earth is shaped in square double-moulds with no base (figs. 203, 204).

There are two types of mould:

- Type A is an ordinary mould giving an intact brick in which a hole is pierced 24 hours

FIGURE 203: MOULDS USED AT CAYALTI.

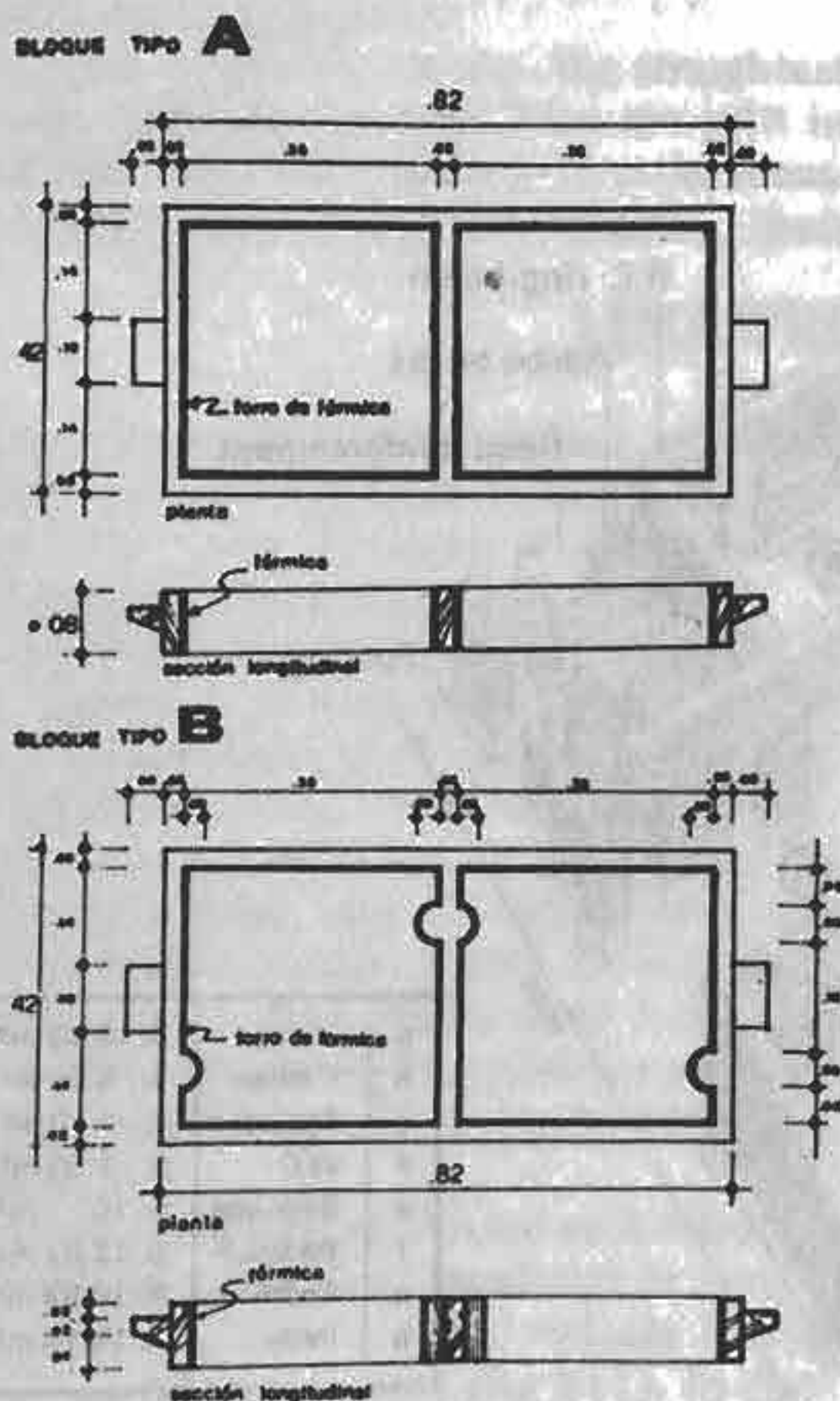
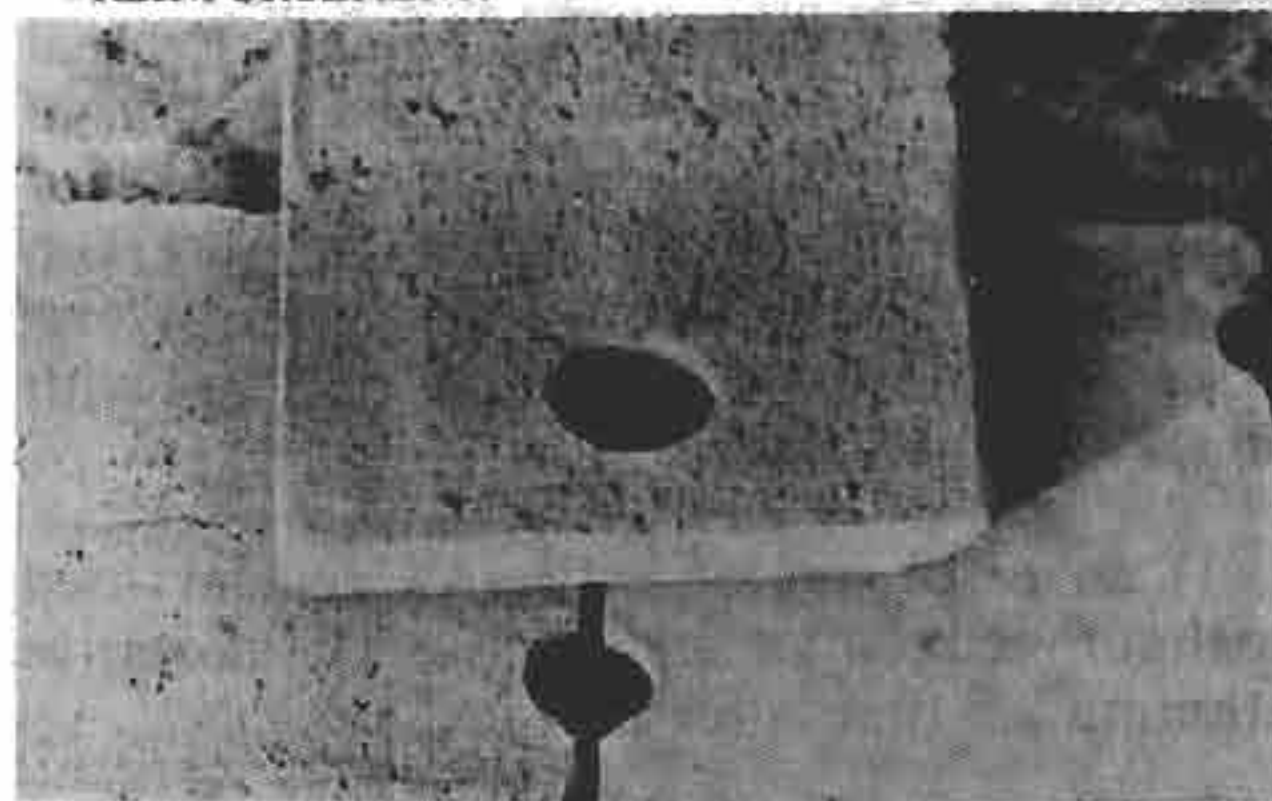

FIGURE 204: BRICKS PIERCED TO ALLOW VERTICAL REINFORCEMENT.



Ministerio de Vivienda y Construcción - Perú

after the mould is removed in order to be able to "thread" it onto the reed.

- Type B has semi-circular indents in two sides; when placed alongside a similar brick, between them they too can enclose a reed. The inner sides of the moulds are covered in formica. They are filled beginning with the corners. The earth is then equalized with a straight-edge. The mould is removed vertically in one brisk movement (fig. 205).

Three days later, the bricks are placed on their sides to facilitate the drying process (fig. 206).

FIGURE 205: REMOVING THE MOULD IN ONE BRISK VERTICAL MOVEMENT.

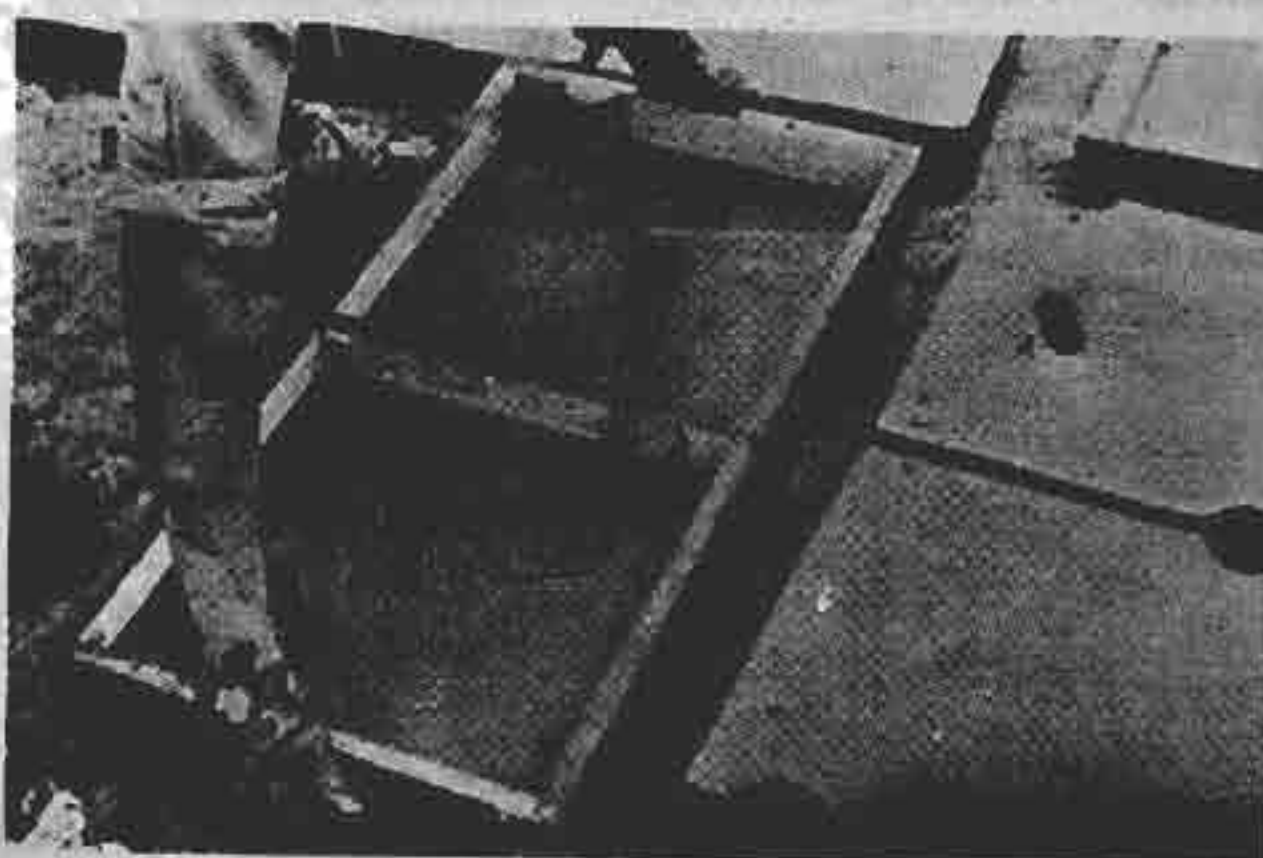

Ministerio de Vivienda y Construcción - Perú

They are ready to be used after one month.

FIGURE 206: DRYING AREAS.



Ministerio de Vivienda y Construcción - Perú

Wall-building

(fig. 207)

- The bricks are carefully cleaned.
- They are then rough-cast with an earth mortar (earth 10 : cement 1 + bitumen 2%). It is not necessary to wet the bricks before laying them.
- The reeds serving as reinforcement are of 2.5 to 3 cm in diameter (species: Carrizo and Caña brava). The reeds are highly water-permeable, so that when placed in the wall, they

FIGURE 207: RAISING THE WALL. THE PIERCED BRICKS ARE "THREADED" ONTO THE REEDS.



Ministerio de Vivienda
y Construcción - Perou

would expand and shrinkage cracks would appear in the mortar enclosing them. To avoid this occurring, they are water-proofed with bitumen. They are brushed with 2 coats of bitumen wash RC 250 diluted at 10 or 20 % in volume in petrol or kerosene. The reeds are left to dry for five days before using them.

- For vertical reinforcements, the straightest and driest reeds are selected. They are split in two vertically and water-proofed. To make it easier to anchor them in the foundations, their

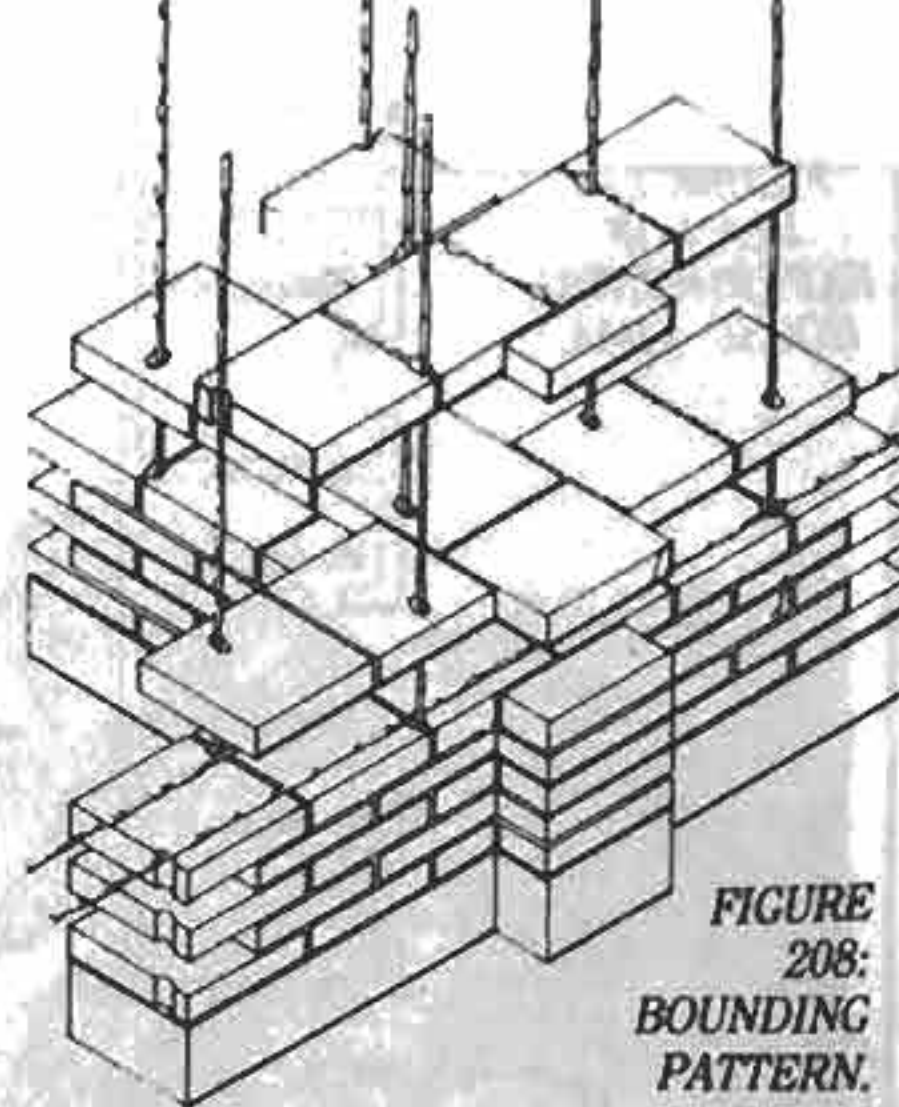

FIGURE
208:
BOUNDING
PATTERN.

ends are set into a little cube of cement. They must line up in the foundation with the spacing of the holes in the bricks.

- Type A bricks as well as type B are laid alternately in each course. Type A bricks are "threaded" down over the reeds and Type B bricks are simply laid on either side of the reeds, their indented sides embracing them. The holes are carefully filled with mortar.

- Reeds placed end to end are to be avoided. If, however, it proves necessary to extend them, they are tied with metal wire at 40 cm intervals.

- The ends of the reeds are anchored in the ring-beam.

- For horizontal reinforcements, the reeds are cut in four lengthwise and water-proofed. Two per course are laid in a mortar bed. The horizontal reeds are tied to each vertical reed before being covered over with mortar.

LIMA PROJECT (1976)

This was the second official project, after that of Cayalti, to use reed reinforcement of adobe walls. In this case, however, a rural coastal model house was to be built.

The experimental space (figs. 209/210) was a basic square unit consisting in four rooms (kitchen, living room, and two bedrooms); the W.C./bathroom was in a small adjoining building. The basic module had a surface area of approximately 50 m², and allowed for an extension of several adjacent rooms located in a separate building. The overall design concept was to create independent buildings each as compact as possible in order better to withstand earthquakes.

The bricks used were stabilized with bitumen RC 250 (RC 2). They were produced in square moulds with two semi-circular indents in the center of two opposing sides (fig 211). In con-

trast to the Cayalti experience, here only one type of brick is used, i.e. that designed to be easily laid on either side of the reeds rather than threaded over them. Special moulds are used to produce half-bricks.

FIGURE 209: COASTAL RURAL HOUSING. EXPERIMENTAL ADOBE HOUSE (LIMA, PERU).



CRATerre

FIGURE 210:
PLAN OF
EXPERIMENTAL
HOUSE, LIMA.

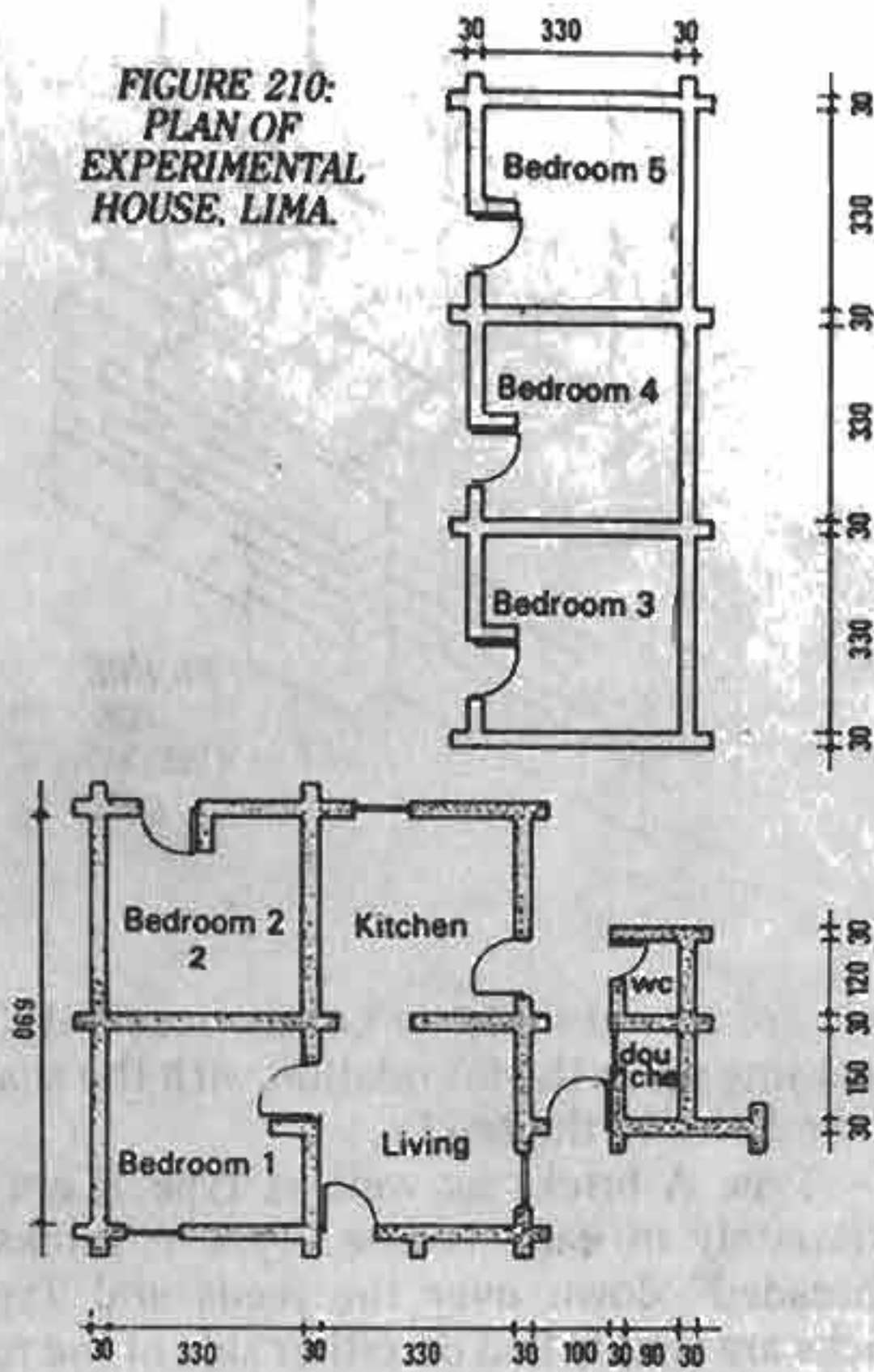

- The bricks are 28 × 28 × 8 cm in size.
- The half-bricks are 28 × 13 × 8 cm.

The moulds used have a rough-finish base with 2 mm grooves enabling air to penetrate and facilitate removing the mould. The method used

FIGURE 211: MOULD AND BRICK
(EXPERIMENTAL HOUSE, LIMA).



is the same as has already been described as the "sand impact" method.

The walls are built (fig 212) in the same way as in Cayalti. The mortar used consists in cement (1 part) and sand (8 parts). The horizontal joints were 2 cm thick and the vertical joints were not less than 1.5 cm. All the walls, including partition walls, overlapped at corners to form buttresses.

The roof covering is made up of modular units each of which covers one room. These units in the shape of paraboïde-hyperbolics

are made of a round eucalyptus on which are nailed reeds, which are in turn covered in 4 cm of earth stabilized at 4% bitumen. A cost analysis was carried out by the testing and standards office, "Officine de Investigacion Normalizacion".

A 91.35 m² building came to 166,670 Soles or approximately 4,000 FF; (the average monthly salary of a Peruvian civil servant is approximately 300 FF).

FIGURE
212:
BONDING
PATTERN.

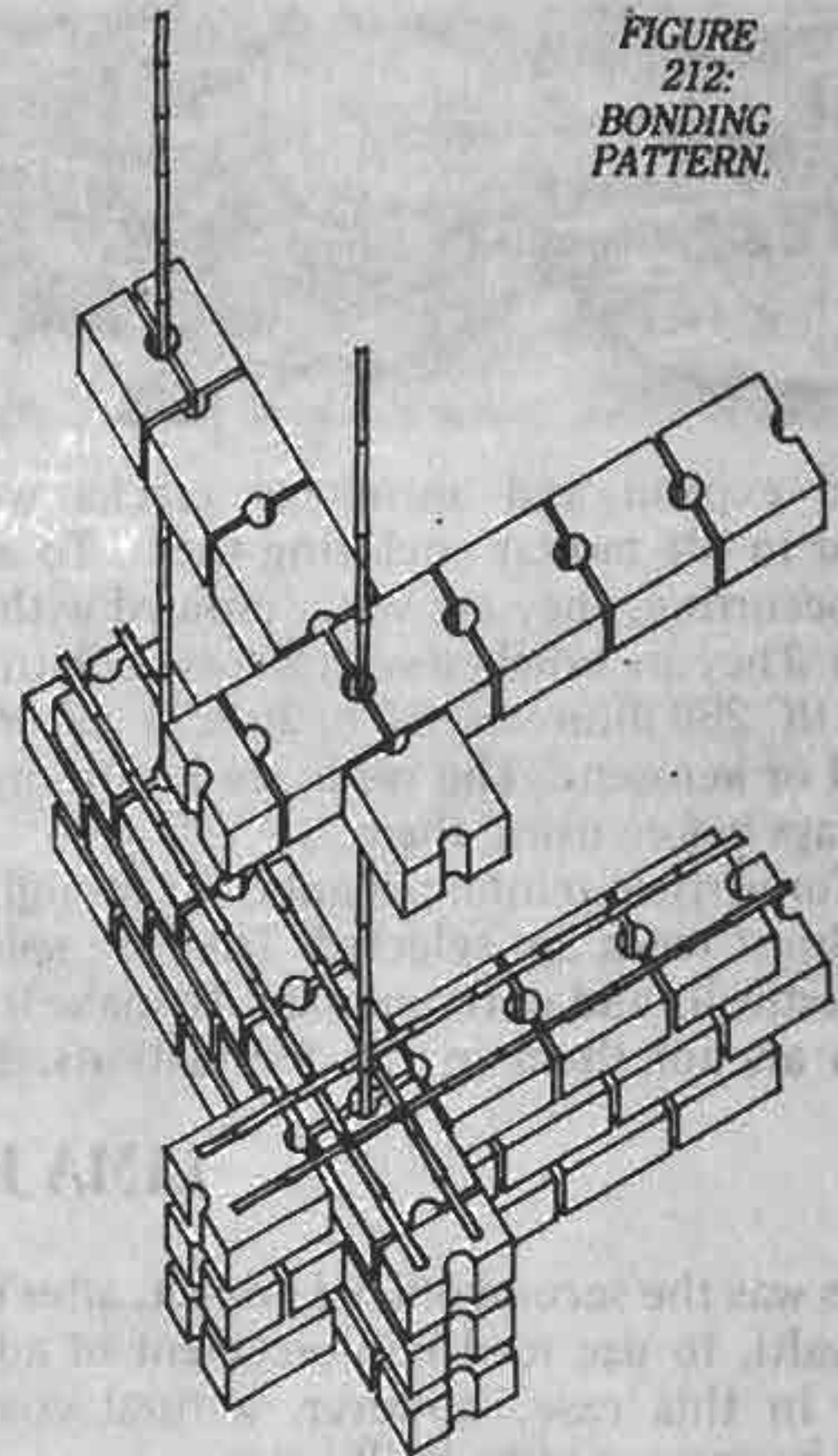

The cost can be broken down as follows:

Footing foundations	11%
Concrete elements (ring-beam etc.)	5%
Adobe walls reinforced with reeds	33%
Floors (concrete, tiling)	6%
Roofing	11%
Interior renders and paint	7.5%
Door-frames and window panes	11%
Bathroom/W.C.	6.5%
Water and electricity	9%

The adobe walls in fact represented 27% of the cost price of the building and the reed reinforcements 6.6%. The cost per m² of adobe wall 28 cm thick came to 378 Soles, or 9 FF and the reeds to 11 Soles (0.30 FF) per linear metre.

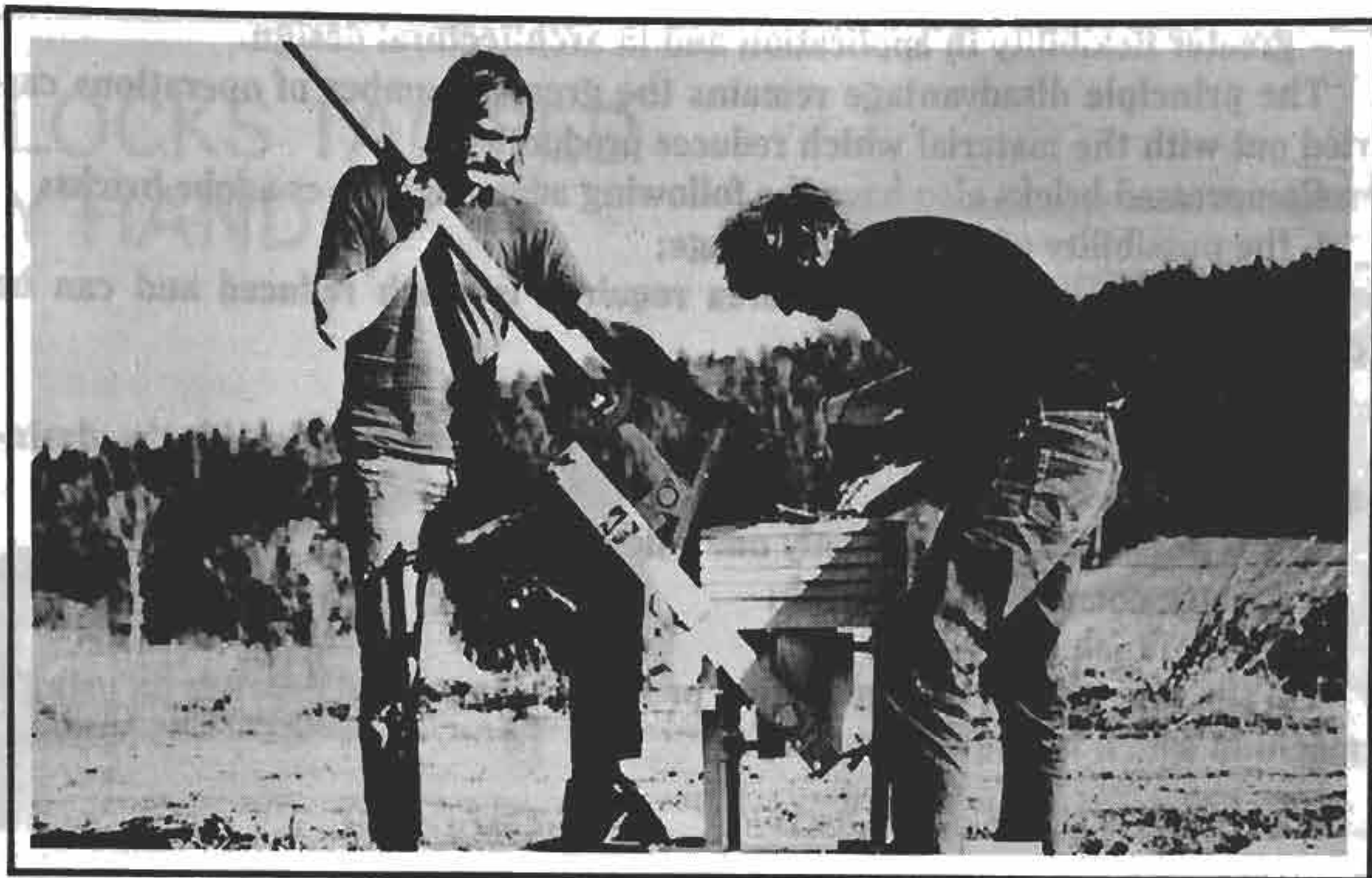

CRA Terre

4. COMPRESSED EARTH BRICKS

We have seen in the chapter on adobe construction how it is possible to make bricks from earth in a plastic state. We now turn to so-called “dry earth”, that is to say with the same water content as for rammed earth construction, which can be compacted with a rammer or a press to make compressed earth bricks. After drying, these can be used in the same way as adobe bricks, fired bricks or cement blocks.

In comparison to rammed earth, this production method has the same advantages as adobe bricks, i.e.:

- the possibility of phasing production over a long period;
- less likelihood of cracks appearing in the wall, as shrinkage occurs in individual bricks at the time of drying;



- greater flexibility in application and in architectural design.

The principle disadvantage remains the greater number of operations carried out with the material which reduces productivity.

Compressed bricks also have the following advantages over adobe bricks:

- the possibility of immediate storage;
- the production and drying area required is much reduced and can be covered;
- the bricks are more regular;
- specially-shaped blocks are possible: hollow, or interlocking blocks, drainage, or roof tiles etc.;
- it is possible to stabilize only one side of the block;
- greater compressive strength;
- better finish.

On the other hand, the production process is longer and depends on using a machine which is frequently costly.

MANUALLY COMPRESSED EARTH BLOCKS

One example of block production and use illustrated is that from the Bas-Dauphiné (France) (fig. 214). This process, which has the advantage of using very little material, allows whatever shape one requires to be compacted in moulds. It is, however, rarely used as it is much longer than that of rammed earth.

After the second world war, this type of production was used in France and in the German

Democratic Republic (fig. 213) for a few social housing reconstruction works. The blocks were produced in wooden moulds filled with earth and tamped with a 6 kg rammer. Two experienced men with ten individual moulds could produce 200 to 250 blocks of $10 \times 20 \times 40$ cm or 100 to 150 blocks of $20 \times 20 \times 40$ cm per day. The work is long, arduous and slow. We will not linger over this method of compression, as today there are presses which replace and improve on it, and these are examined in detail in this chapter.

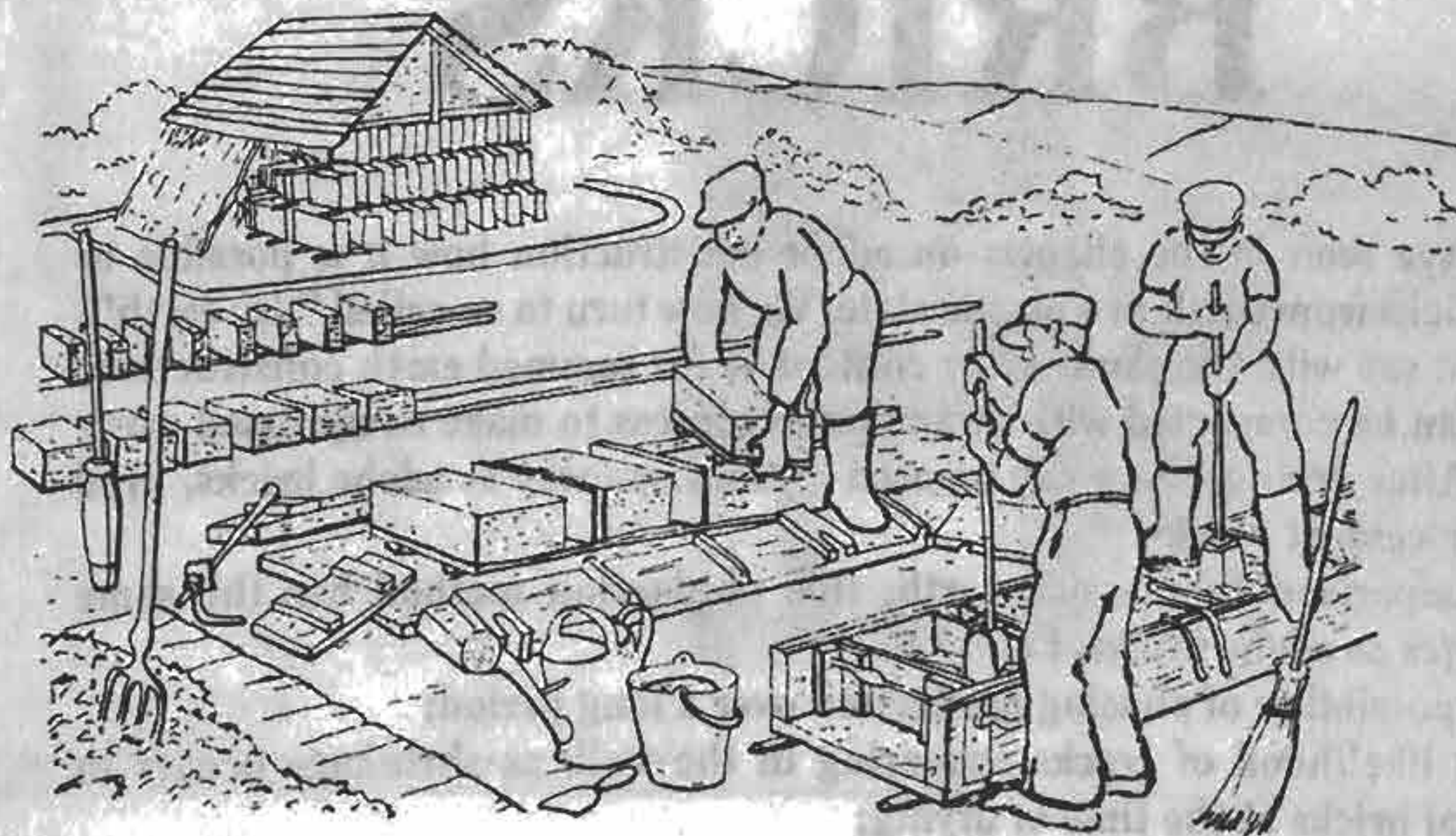
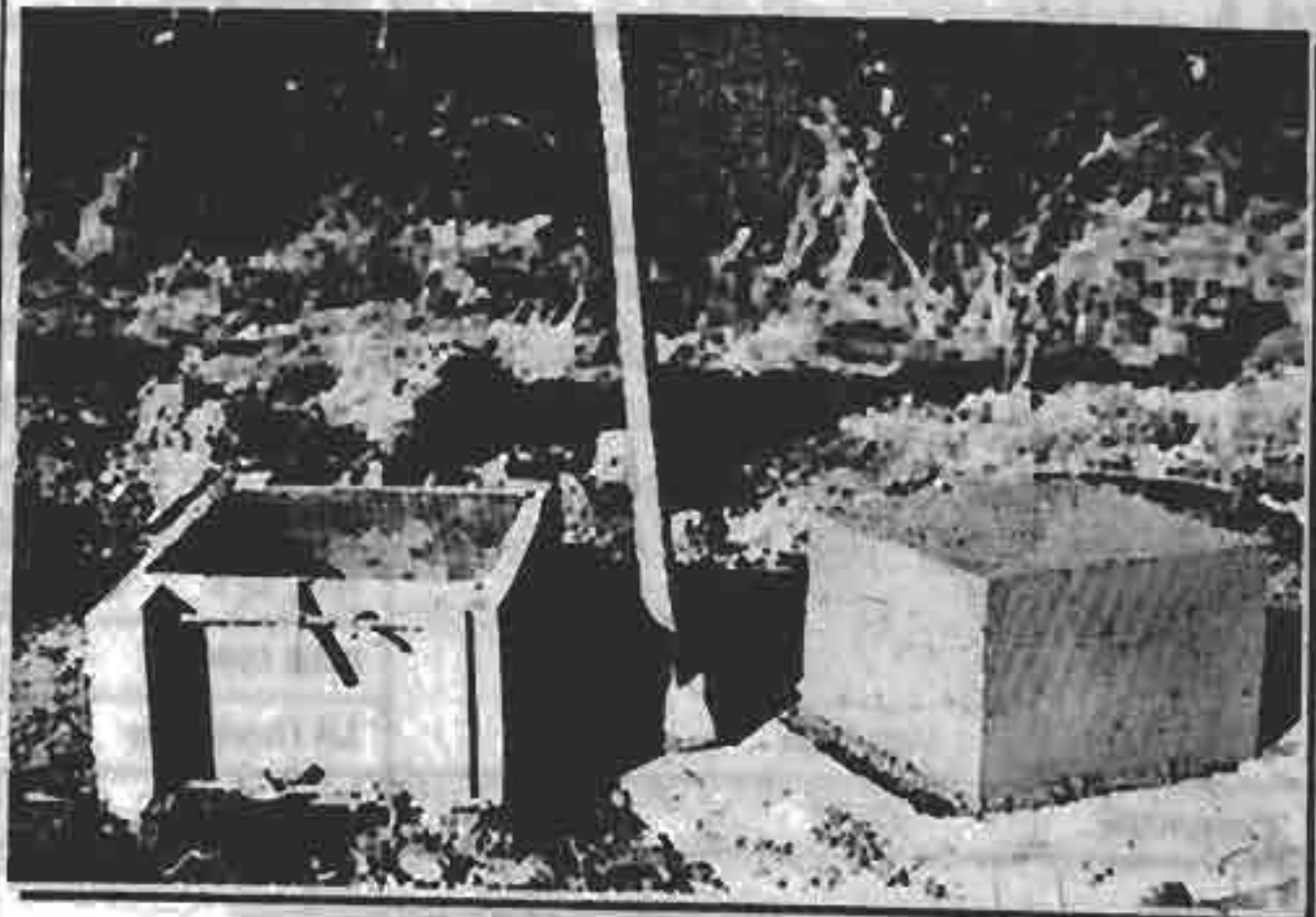
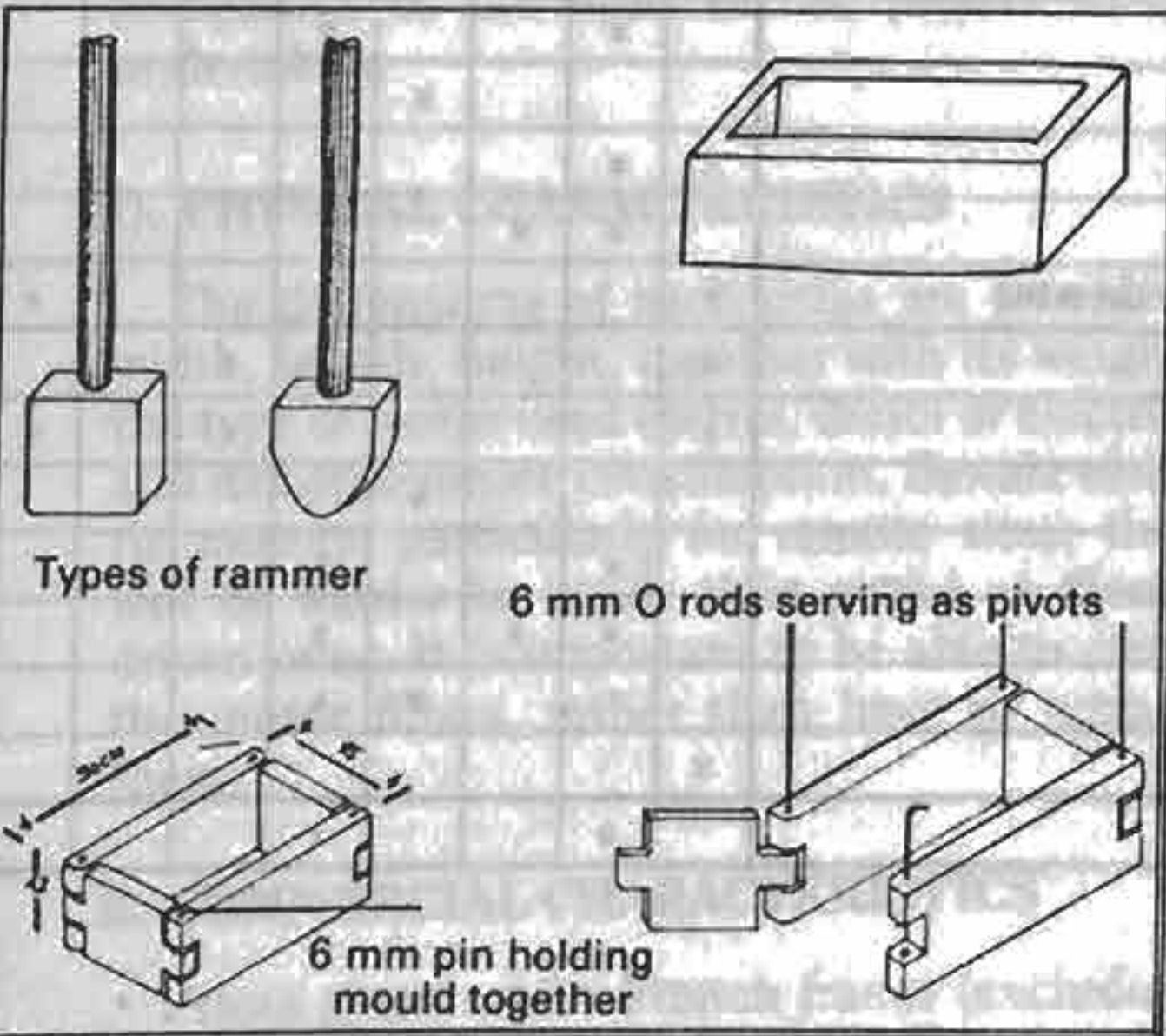
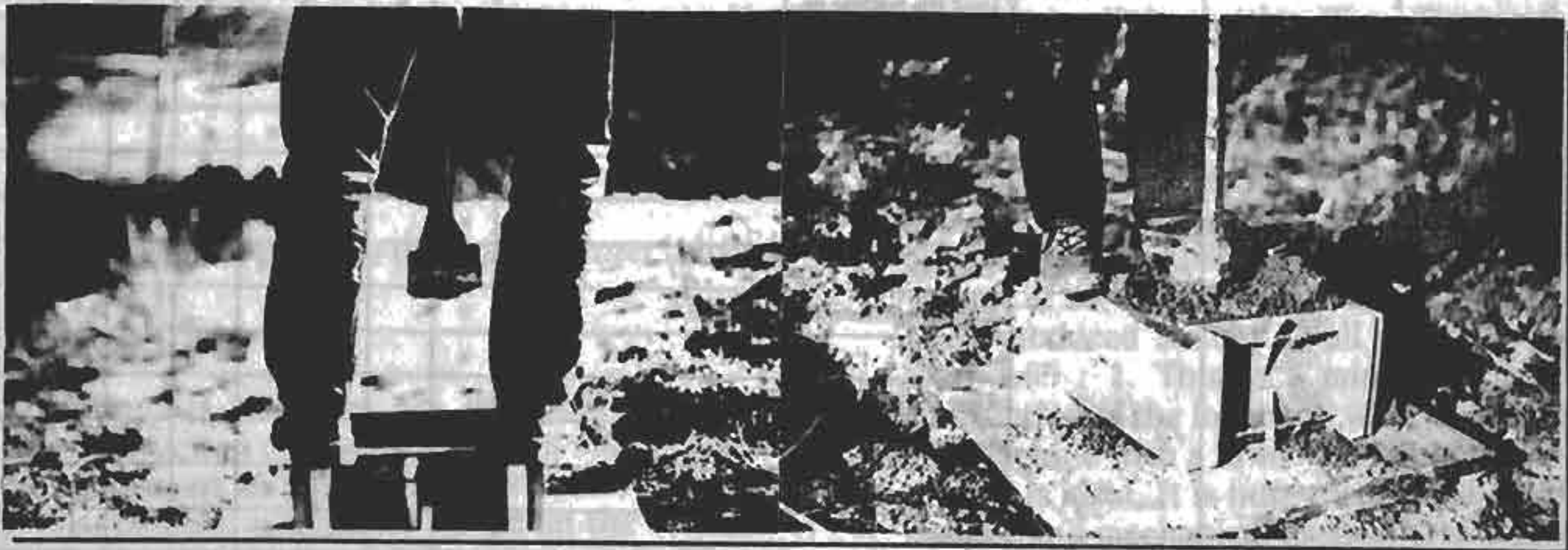
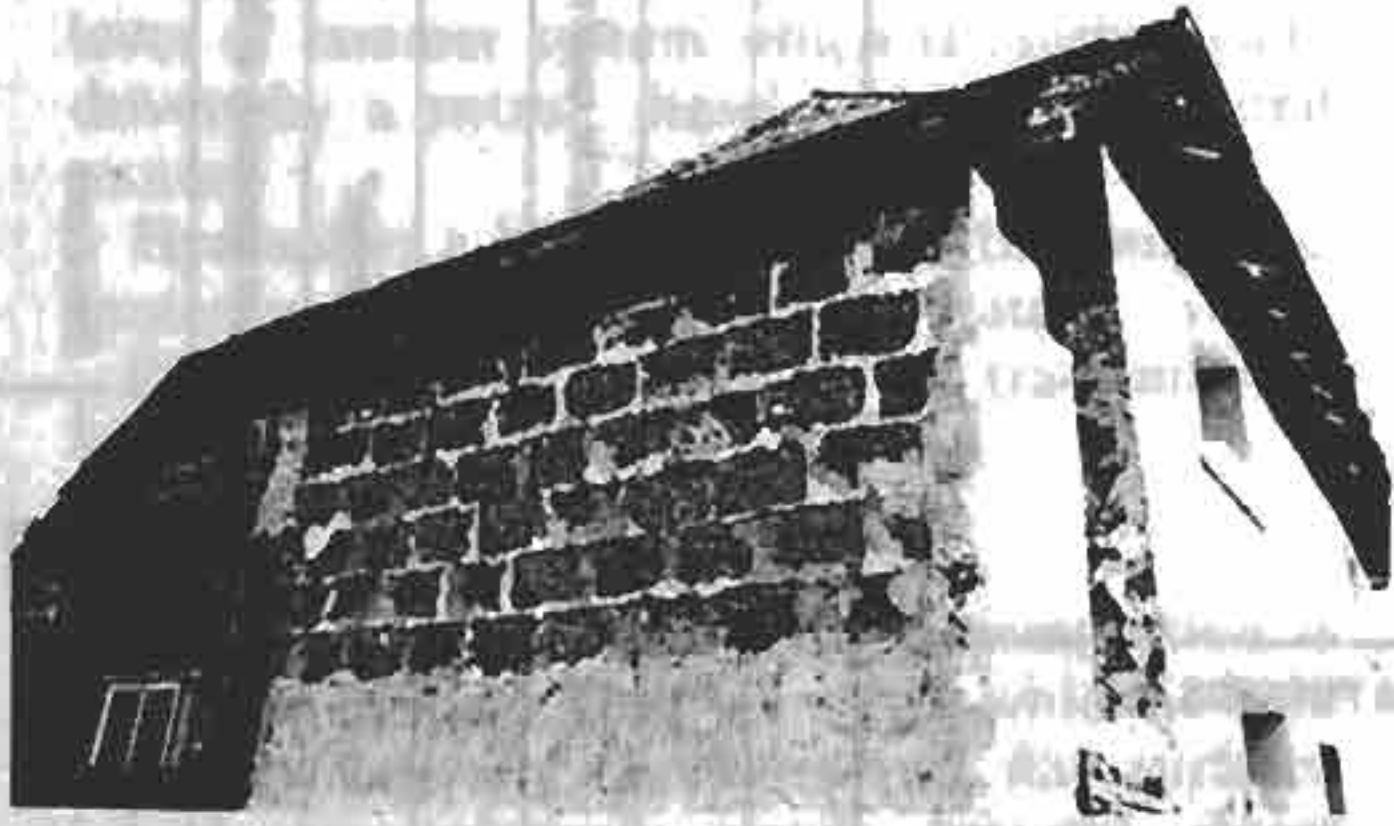

FIGURE 213:
EARTH BRICKS
BEING TAMPED
BY HAND,
G.D.R.

FIGURE 214:

BLOCKS TAMPED BY HAND



PRESSES

A great many presses are used in the ceramics industry to make bricks. Several can be used as they stand for stabilized earth, others have been modified and some have been designed specifically for compressed earth blocks. There are also others which have some particular potential, but which would need to be adapted.

Twenty-eight are presented here, of which six are of particular interest and commercially available. The latter are listed again in a more detailed table. The others, which are not on the market, are listed as examples; they include experimental prototypes of which only one was built and presses which were not widely used and which disappeared from the market some twenty-five years ago.

The first table lists the whole range, from the very simplest hand-press requiring little capital investment and capable of being built by local craftsmen, to the most sophisticated machinery demanding a considerable supply, production and storage infrastructure.

TYPE OF MOULDING METHOD	PRODCUTION RATE	TYPE OF COMPRESSION	28 PRESSES	Commercially available	No longer on the market	Could be put back on the market for special multiple order	Prototype	See section on "Press museum"	See our selection of best commercially available presses	State of earth		
										Dry	Plastic	
Manual	Low	Dynamic	B.I.T. Dakar		x			x				
			Lever arm machine no. 1		x			x				
			Lever-arm rammer type PBB		x				x			
			"Rapide" no.5		x				x			
			System D rammer guide					x	x			
		Static	Terstaram*	x						x	x	x
			CINVA Ram	x						x	x	x
			Tek Block	x						x	x	x
			Elson Blockmaster S, D, SB 1, SB 2	x						x	x	x
			ABI	x							x	x
			Lever arm manual press		x					x		
			Hercules		x					x		
			Curer					x	x			
			Palafitte						x			x
Mechanical	High	Dynamic	Type C Houdra		x			x				
			No. 1 mini-rammer		x			x				
			Rammer guide					x	x			
		Static	Majo	x	x				x			
			Majomatic		x	x			x			
			Hallumeca - B 75, B 100, 150, B 200	x								x
Hydraulic	Medium	Static	MMH 2000	x					x	x		
			CLU 2000	x					x		x	
			Power Tek Block					x				
			Winget		x				x			
			10 P, 11 P		x	x			x			
			MMH 4000					x	x			
	Very high		L3 Drosthalm	x							x	
Pneumatic	Poor	Dynamic	Type 810		x			x				

* This press has been previously marketed under the following names:

- The Madelon
- The Super Madelon
- Landcrete
- Stabibloc
- S.M.

Press characteristics

A. TYPES OF PRESS

Presses can be classified by energy source:

- **Manual:** in this case compression is achieved by one or more people using a lever or rammer system.
- **Mechanical:** compression is achieved by a lever or rammer system which is mechanically driven by a petrol, diesel or electric-powered motor.
- **Hydraulic:** a hydraulic system transmits the motor power to the compaction plate.
- **Pneumatic:** a pneumatic system transmits the motor power to a rammer.

Method of compression:

- **Static pressure,** in which the compaction is achieved by squeezing the earth, which is held in place laterally, between two flat surfaces which are relatively slowly brought closer together;
- **Dynamic pressure,** in which compaction is achieved by ramming the earth in a mould, the pressure exerted on the brick being difficult to control.

B. NAME

The name given by the manufacturer is listed.

C. ORIGIN

Certain machines are marketed by several construction companies. Readers with a particular interest in purchasing a press are invited to contact the authors for advice on the choice of presses available and the choice of different companies in the light of the project to be undertaken.

D. PHYSICAL CHARACTERISTICS

The dimensions of each press are provided: width, length, height, together with its weight, the type of motor used (petrol, diesel or electric) and its approximate consumption. Beware electric motors, particularly for remote sites; they will be harder to repair than petrol or diesel-driven ones. It is important to be able to clean the motor filters, rather than have to replace them.

E. COMMERCIAL CHARACTERISTICS

Prices given are in French francs (excluding tax). Delivery times have been confirmed by the

manufacturers, and run from the date of receipt of a final, confirmed and irrevocable letter of credit. Delivery times exclude transport and customs clearance.

F. QUALITATIVE CHARACTERISTICS

● **Pressure:** A high proportion of the initial power is lost through transmission, friction and the elasticity of the material. Compaction pressures of 7 to 10 kg/m² can be sufficient but are minimal, pressures of 20 to 40 kg/m² are excellent. Higher pressures serve no useful purpose and waste energy. They sometimes cause a deterioration in the mechanical properties of the blocks as a result of lamination effects.

The pressures given are those obtained in the course of production, that is to say the statistical average of one operator working for 8 hours, which differs greatly from what it is possible to obtain in practice. For example:

- 1 person, single operation, with a Cinva-Ram = 20 kg/m²;
- 1 person, all day, with a Cinva-Ram. = 5 to 7 kg/m².

● **Compression ratio:** The ratio of loose to compacted earth is theoretically 1.65 : 1. The compression ratio, which expresses the ratio of the volume of the mould empty to the volume of the brick produced should in all cases be greater than 1.65 : 1. This is a minimum, and pre-compaction of the loose soil will be required for any machine with a lower ratio. A possible ratio of 2 : 1 is ideal. It is noteworthy that nearly all manual and mechanical presses have a compaction ratio of less than 1.65 : 1 and therefore require pre-compaction. From this point of view presses with a hinged cover-plate are preferable to those with a pivoting cover-plate. A hinged cover-plate presses down on the earth piled over the top of the mould, thus achieving slight pre-compaction, whereas a pivoting cover-plate scrapes the excess earth from the top without pressing it down. In the latter case the earth has to be pressed down lightly by hand to make up for the low compression ratio. (The figures shown in brackets on the table are the author's own estimates.)

● **Maximum depth of mould:** This is the maximum distance between the closed cover-plate and the compression plate when not in use. This measurement less the distance the plate travels gives the maximum possible thickness of

the block. For the production of roof or floor tiles, the depth of the mould can be reduced by inserting a piece of hard wood. One should aim for the greatest depth possible in order to achieve an acceptable compression ratio. With hydraulic presses which have compression ratios of 1.8 to 2 or more to 1, the moulds can be filled through a hopper.

- **Maximum travel of the plate:** On manual and mechanical presses this cannot be adjusted. Not driving the handle home may give the impression of making an adjustment, but in fact as it is at the end of the movement that the maximum compression is achieved, bricks produced in this way will be a great deal less strong. On hydraulic presses the height of travel is easy to adjust.

- **Block dimensions:** Standard block dimensions are given. It should be noted that some producers have allowed for the possibility of using several moulds to produce blocks, bricks and tiles of various sizes.

G. PRODUCTION RATE

- **Number of blocks per day:** The figure quoted represents the number of blocks produced during an 8-hour day, but this can vary enormously according to the site organisation.

- **Daily compacted volume:** The volume of compacted earth produced per day in m^3 .

- **Number of operators:** This is the number involved in filling the mould, compressing the earth, and removing the block. It does not therefore include the entire production process from excavation to stockage. (?)

- **Four production rates are given:**

- Poor: applied to manual presses the production of which varies - according to the site organisation - between 300 and 1200 blocks per day.

- Medium: mobile hydraulic presses produce between 2000 and 2800 blocks per day, the output being dictated by the speed of the automatic mould rotation.

- High: Mobile mechanical presses have high production rates as they are made for use with earth in plastic state. This consistency allows

much faster compaction than with "dry" earth.

- Very high: Very sophisticated hydraulic presses, developed from the industrial production of silico-calcium (?) bricks achieve extremely high outputs. These presses require a considerable infrastructure and very experienced operators.

CRATerre's "Palafitte" press

(fig. 215)

Only one model of this manual press was built in an attempt to combine the qualities of the Cinva-Ram and the Tek-Block presses.

MANUFACTURE

The "Palafitte" press was built by the Architecture Teaching Unit of Grenoble. First, a full-scale model of the CINVA-RAM press was built in order to gain a better understanding of the systems of compression and removal of blocks. Working from the model, it was decided to link the cover-plate to the lever in order to automate the opening and closing of the press.

Building the press cost us 250 French francs. All the necessary cutting was done by hand with a metal hack-saw. One of the problems we encountered while making the press was that the two long sides of the box and the piston plate were deformed during soldering. When the reinforcements of the mould were soldered, the plates buckled under effect of the heat and we found it difficult to redress them. Thicker sheets at these points (12 instead of 8 mm) would avoid the need for reinforcements.

PRESSURE

It is rather difficult to determine the pressure exerted by the piston since the lever arm yield varies continuously as it is compressed.

If the arm is lowered to the point where it is horizontal to compress the earth, it then springs back slightly by about 10 degrees. This is due to the earth's elasticity and that of the press which is subjected to the pressure and then instantly regains its original volume. The final pressure can thus be calculated at an lever arm angle of 80° to 70° which gives a pressure of 9.5 to 4.4 T, or 23 to 10 kg/cm^2 . An average pressure of 16 to 17 kg/cm^2 . can therefore be assumed, this figure being a theoretical calculation rather than a "stress measurement".

FIGURE 215: "PALAFITTE" PRESS (BUILT IN 1975 BY MEMBERS OF CRATerre).

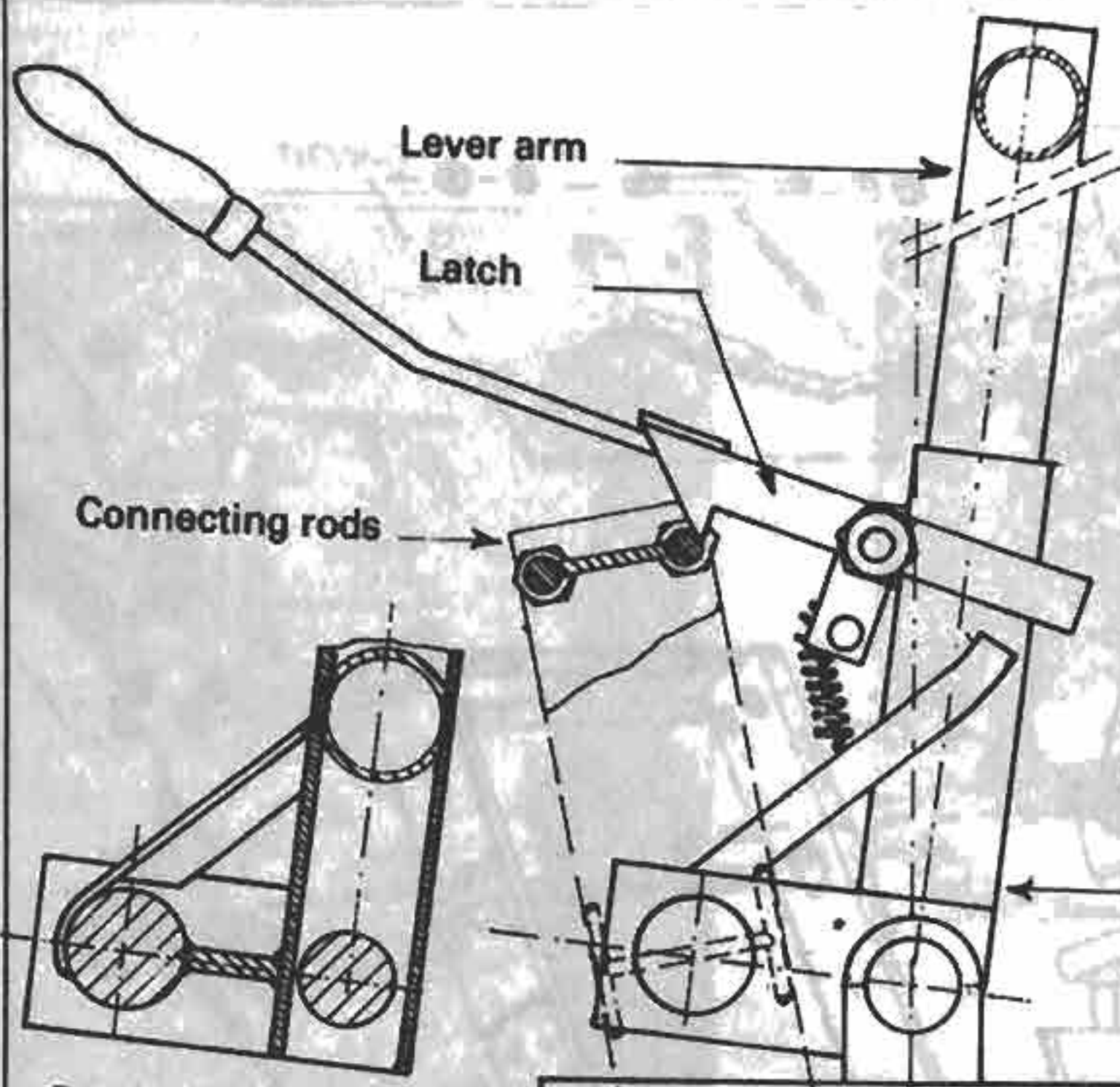

"PALAFITTE" PRESS.

Manual press for the production of mixed earth blocks

- block measurements 29 cm x 14 cm x 9 cm
- compaction strength 14 to 20 kg/cm²
- compression ratio 2 : 1

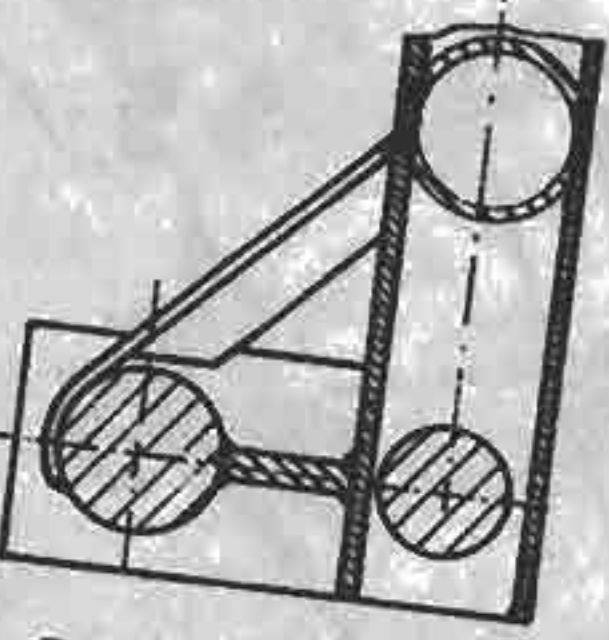

Section of elbow

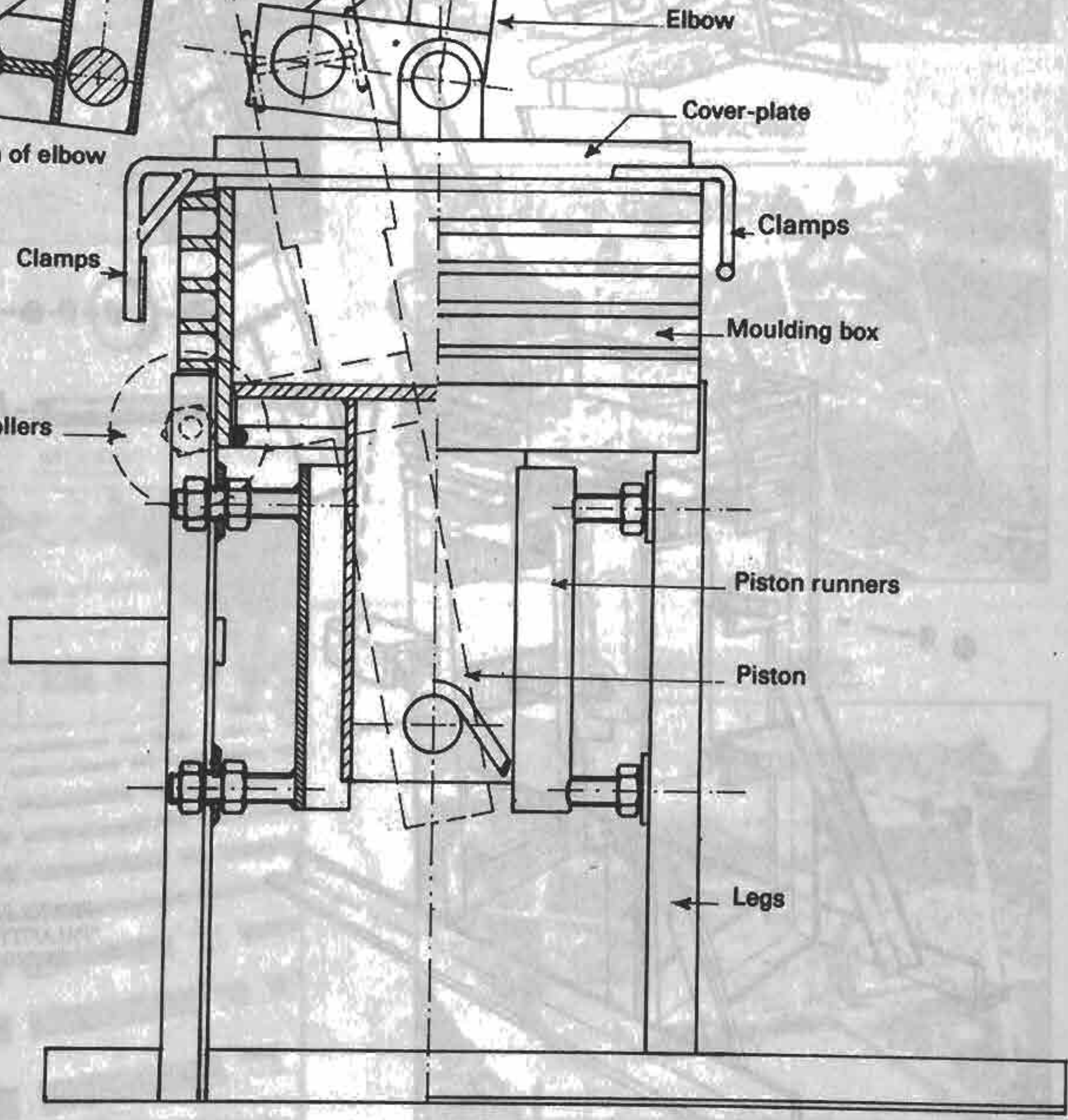

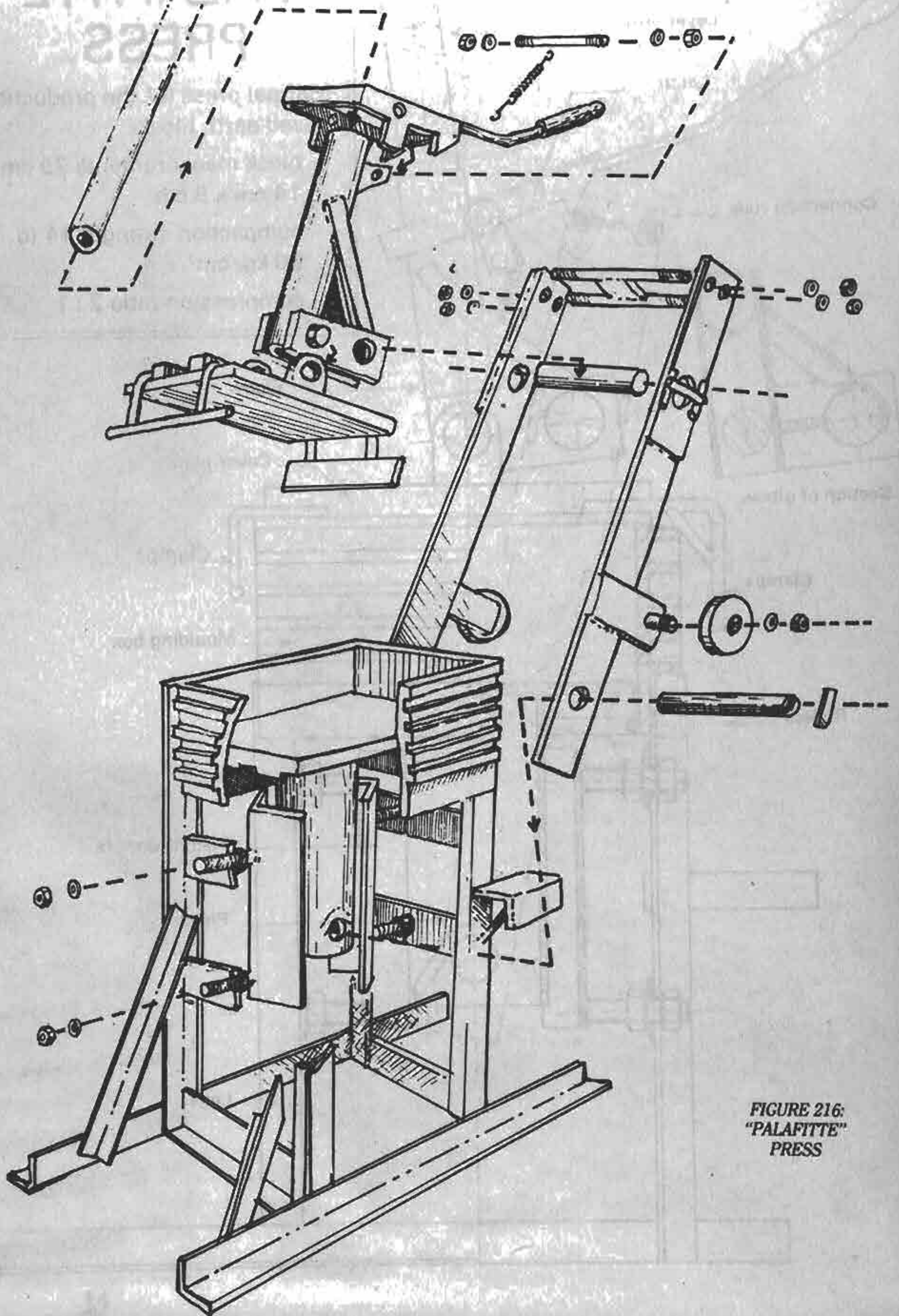

FIGURE 216:
"PALAFITTE"
PRESS

FIGURE 218: BRICK PRODUCTION USING A PRESS (VIGNIEU - ISERE, FRANCE)

SIEVING



FILLING THE MOULD



COMPACTING

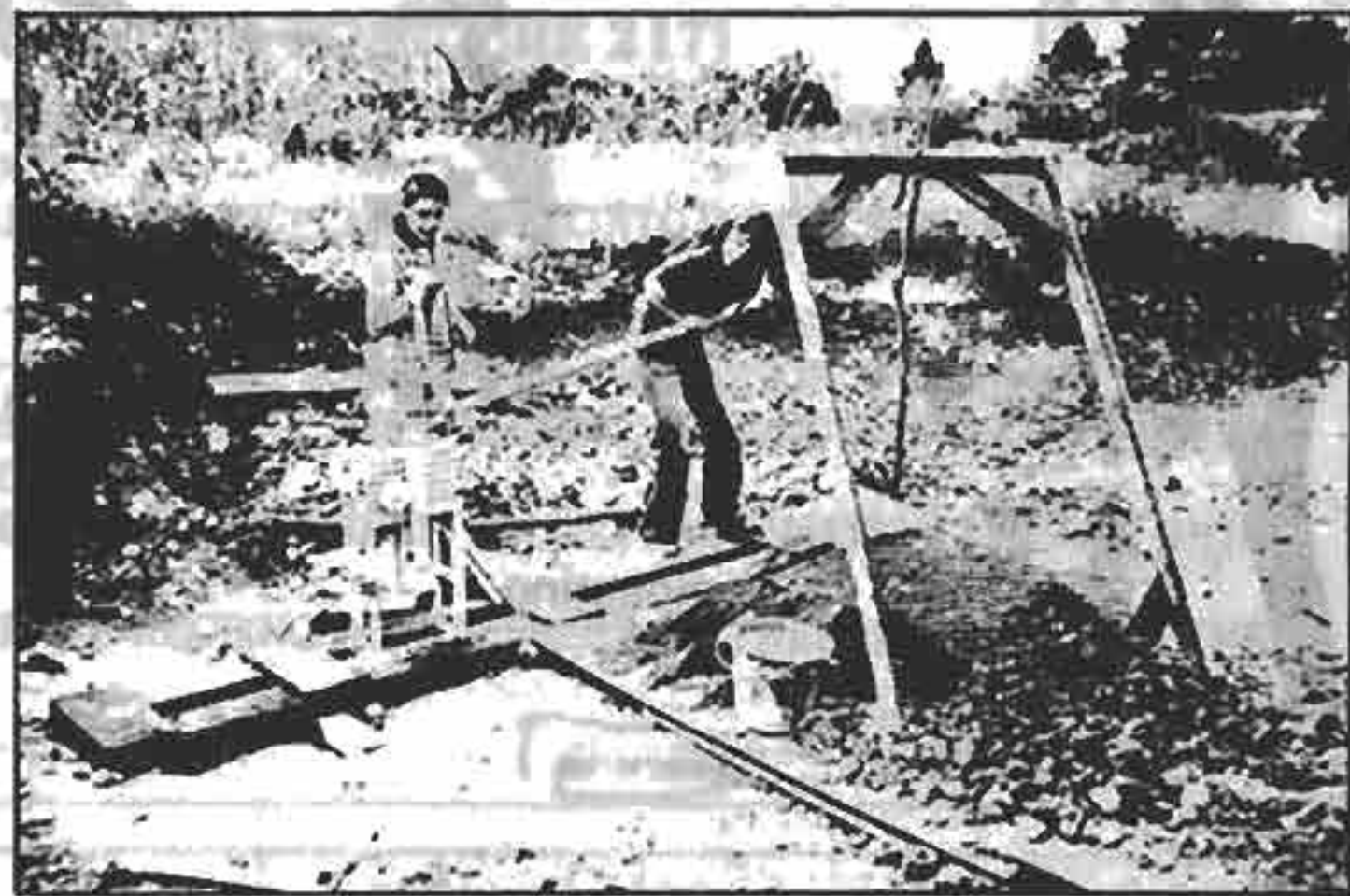

STOCKING



REMOVING THE BRICK

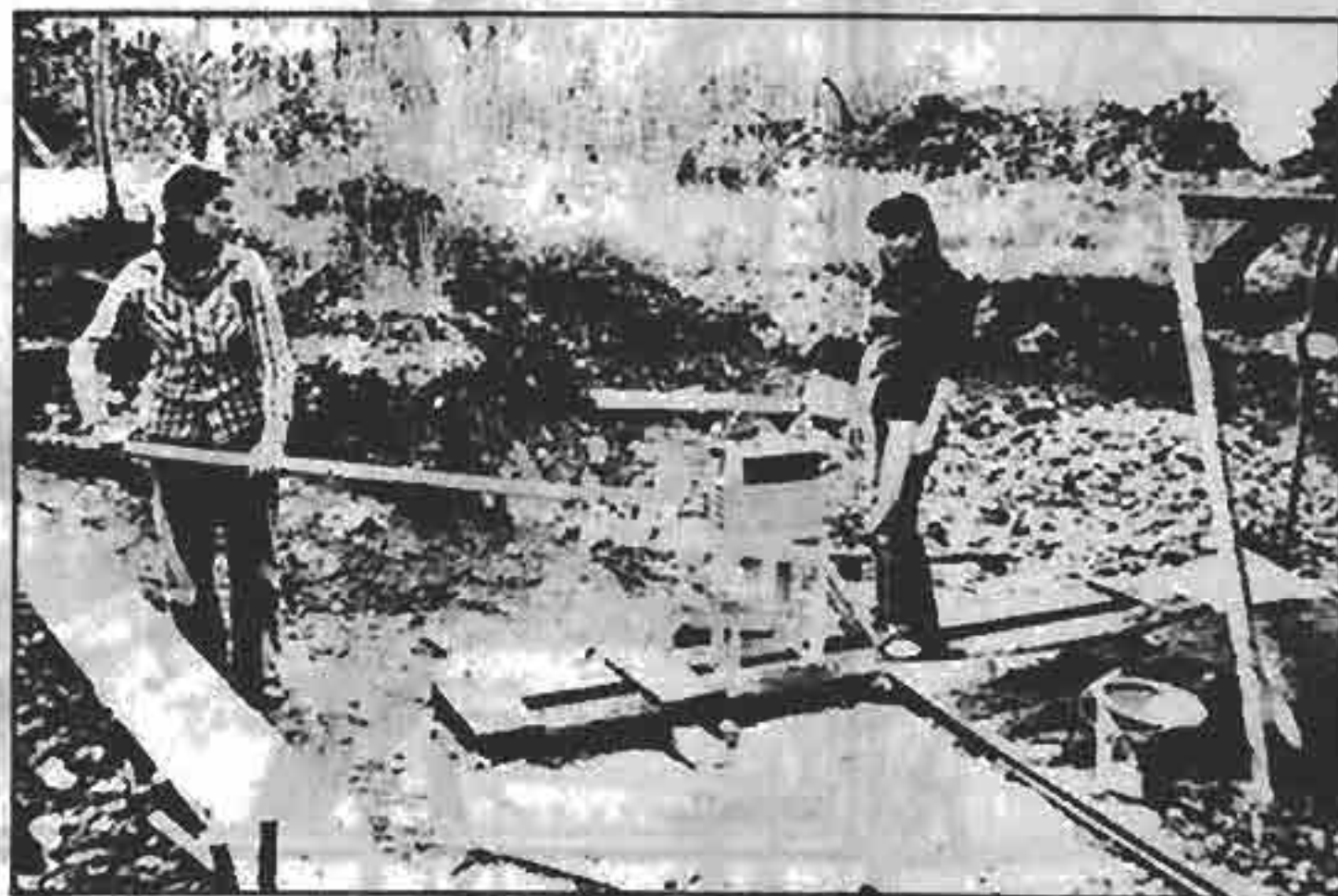

"PALAFITTE" PRESS — THE 1 st BRICK



Filling the mould



Compacting



Removing the brick



PRODUCING A BLOCK
(fig. 217)

FILLING THE MOULD

For most presses a precise quantity of earth should be placed in the mould to obtain an acceptable block. To achieve this scales are used or a measuring scoop corresponding to the amount of earth needed to produce a dense block. Only after several trial blocks have been produced will the amount required be known. The earth should not contain any gravel (over 5 mm) and the water content should be the same as for rammed earth.

- Note: Neither the length nor the width of the block can be reduced. Only the height can be shortened by inserting a piece of wood on the base plate of the mould.

COMPACTING

The quality of the compaction depends on the amount of earth placed in the mould. The amount will be right when the operator, holding the end of the lever-arm, uses his whole weight to push it down until it is horizontal.

REMOVING THE BRICK - DRYING

The freshly compacted brick should be handled with care. It is revolved to unstick it from the base-plate and then lifted off and taken to the drying area. Cement or lime-stabilized bricks should be cured in damp conditions for at least one or two weeks to allow for proper hydration of the binding agent. It is therefore preferable to stack them closely together in a warm humid area. Non-stabilized or bitumen-stabilized bricks can be dried more quickly similarly to adobe bricks.

USING THE PRESS

(COMMENTS RELATING TO FIGURE 217)

- 1) HOLD THE LEVER ARM IN THE "OPEN COVER-PLATE" POSITION, LEAVING THE PISTON LOWERED. FILL THE MOULD-BOX USING THE MEASURING SCOOP.
- 2) RAISE THE LEVER ARM VERTICALLY UNTIL THE COVER-PLATE COMES INTO CONTACT WITH THE MOULD BOX.
- 3) UNBOLT THE HOLDING PIN TO RELEASE THE LEVER ARM FROM THE COVER-PLATE.
- 4) PULL THE LEVER ARM DOWN UNTIL IT IS HORIZONTAL, WHICH LIFTS THE PISTON AND COMPACTS THE BLOCK. IF THE MOULD-BOX HAS BEEN CORRECTLY FILLED, THE PRESSURE NEEDED TO PULL THE LEVER DOWN WILL BE EQUIVALENT TO A MAN'S WEIGHT.
- 5) RETURN THE LEVER ARM TO ITS ORIGINAL POSITION, WHICH BOLTS IT AUTOMATICALLY BACK ONTO THE COVER-PLATE.
- 6) LOWER THE LEVER ARM, ALLOWING THE CONNECTING RODS TO REST ON THEIR ROLLERS AND THE BLOCK IS EJECTED.
- 7) RETURN THE LEVER ARM TO POSITION 1...

FIGURE 222: TEK-BLOCK PRESS
— FILLING THE MOULD
— COMPACTING
— REMOVING THE BRICK

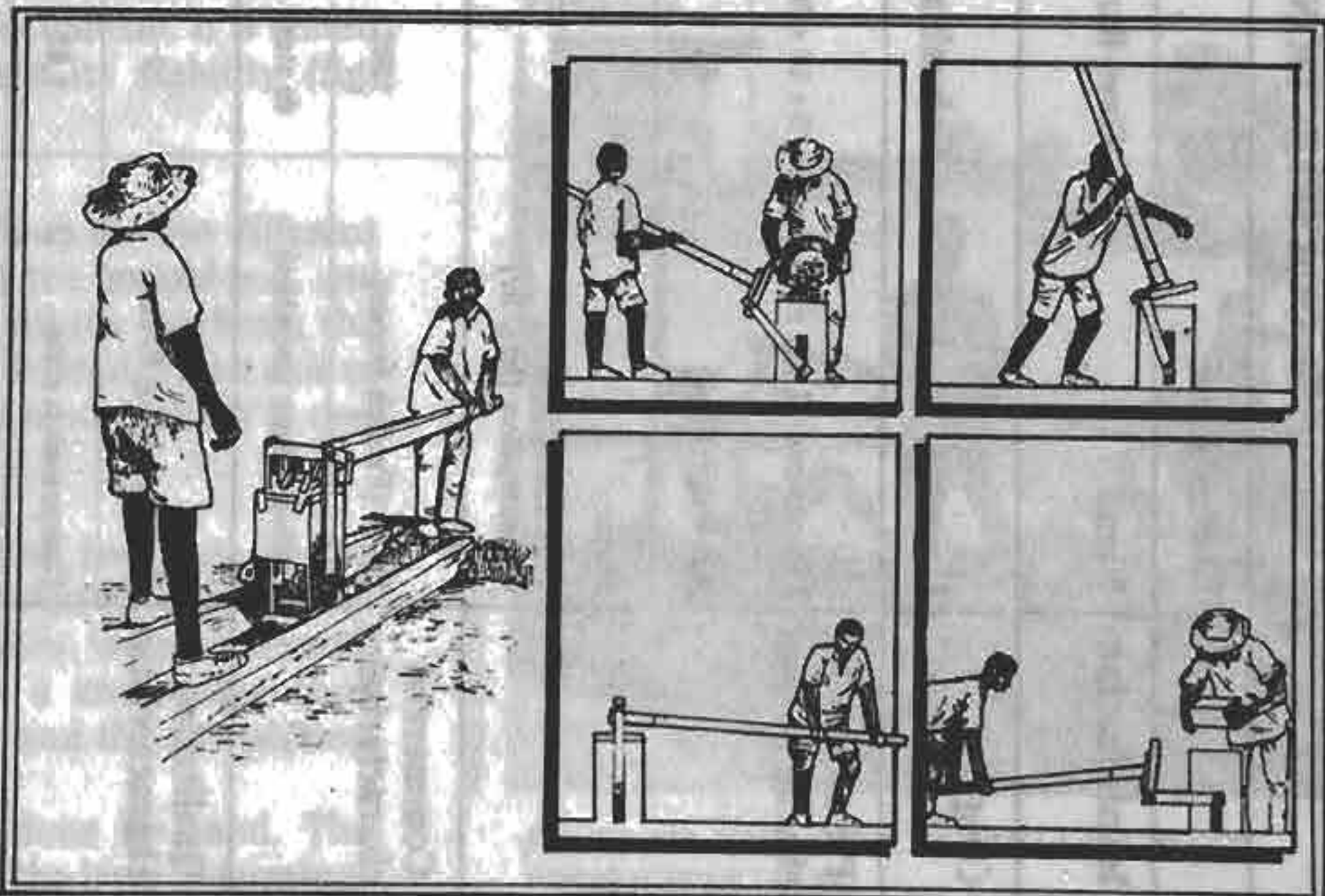

CRATerre

OUR SELECTION OF PRESSES OF PARTICULAR INTEREST

Identification	Origin	Energy input	Manual						Hydraulic		
			Cinva-Ram	Tek-Block	S	Ellson Blockmaster SB 1	SB2	SM Terstaram	MMH 2000	CLU 2000	
Physical characteristics	Country	Dimensions (I x L x H) (cm)	Columbia,	Upper Volta,	India	India	India	India	Belgium	Belgique	Switzerland
Commercial characteristics	Dimensions (I x L x H) (cm)	20 x 50 x 60	40 x 50 x 75	40 x 69 x 90	40 x 69 x 90	40 x 69 x 90	40 x 69 x 90	75 x 160 x 100	100 x 300 x 150	150 x 325 x 162	
	Net weight (kg)	63	97	145	155	165	175	280	1350	1550	
Commercial characteristics	Motor								Bernard 10 HP diesel	Hatz E 785 11HP diesel	
	Consumption (ltrs/hr)								2	2	
Commercial characteristics	Price (French francs)	1000	2000	1400	1500	1600	1650	4000	55000	70000 (part. presse)	
	Delivery time (months)	de stock	de stock		de stock	de stock	de stock	3 mois	3 à 6 mois	3 à 6 mois	
Qualitative characteristics	Pressure in kg F/cm	7	5		7 à 25			20	40	20	
	Compression ratio	1,63	1,34	(1,80)	(1,46)			1,65	- 2	(1,6)	
Qualitative characteristics	Max depth of mould-box (mm)	145	175	131	131	158	158	145	175	120	
	Max travel of plate (mm)	55	45	50	50	50	50	39 + 18 = 57	88	45	
Production rates	Standard block dimensions (l x w x h)	29,3 x 14 x 8,9	29 x 29 x 13	22,7 x 10,6 x 7,3 (x2)	22,7 x 10,6 x 7,3 (x2)	30,5 x 14,6 x 10,8	30,5 x 22,5 x 10,8	29,5 x 14 x 8,8	29,5 x 14 x 8,8	25 x 12 x 7,5 (x2)	
	Number of blocks per day	425	425	425	850	425	425	425	2000	2000	
Production rates	Volume compacted per day (m3)	1,55	4,64	0,74	1,48	2,04	3,14	1,54	7,26	9	
	Number of operators required	1	1	2	3	4	4	4,30	3,10	4,60	

Our selection of commercially available presses of particular interest

CINVA-RAM

This manual press was developed in Bogota (Columbia) in 1952 by the Inter America Housing and Planning Center. It is simple, robust, economical and can be built by local craftsmen. The press is widely known and used and has given rise to others based on the same principle (fig. 219).

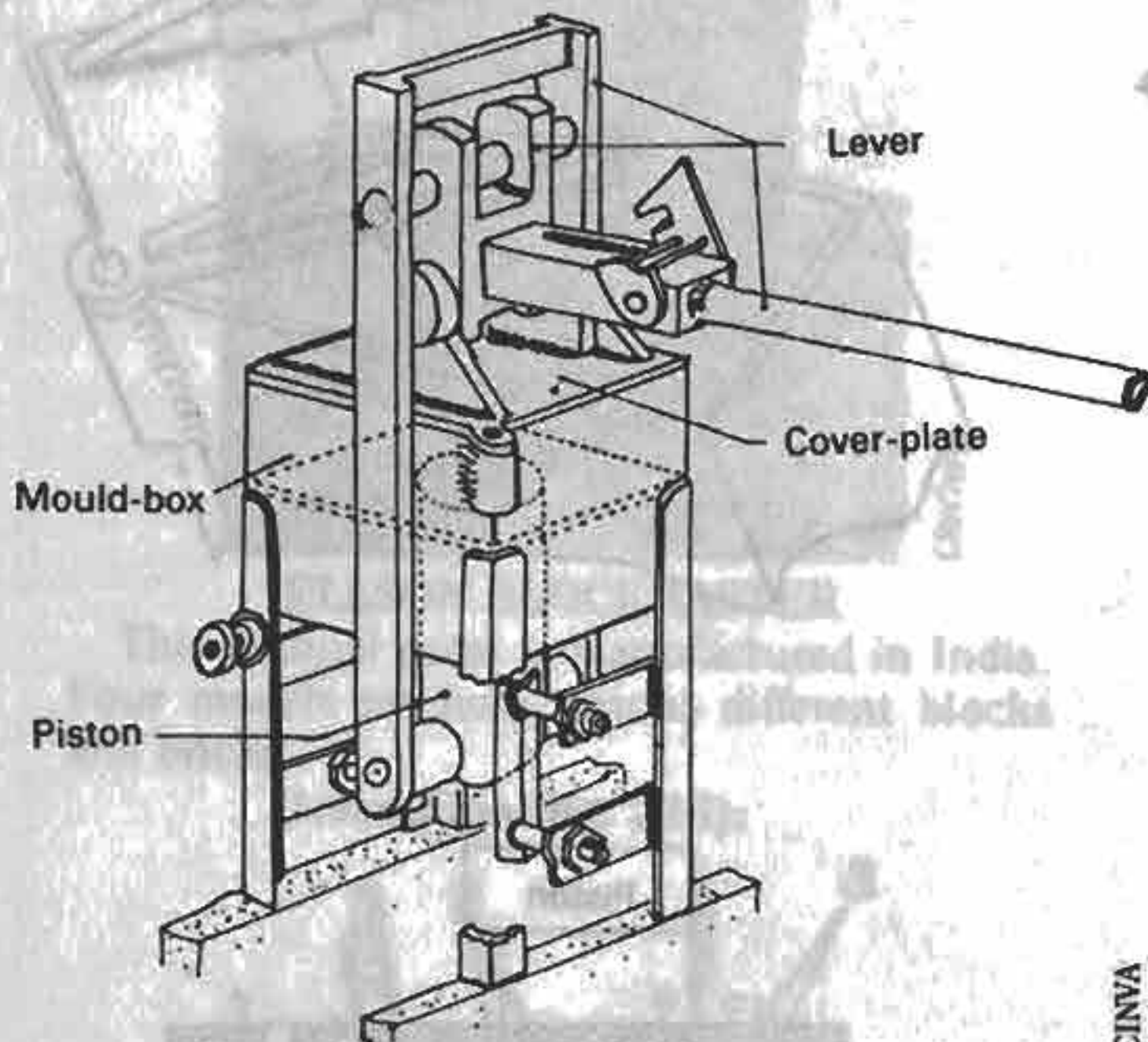

FIGURE 219: CINVA-RAM PRESS

Mould-box: the rectangular mould is made of four sheets of metal 12 mm thick and is mounted on four legs. This constitutes the framework for the entire mechanism. It is bolted onto a base which ensures its stability (fig. 220).

Cover-plate: the design allows for two different cover-plates : one lifts off the mould-box and rests on two supports behind the machine; the other pivots round an axis located on the side of the mould-box. This is the model which is currently being marketed.

Lever-arm: the lever fits into two slots in the cover. Its movement is transferred to the piston thanks to two connecting rods. When it is vertical, two hooks lock onto a cross-piece thus holding together the lever and the connecting rods.

Releasing the hooks is done by hand. The space "a" of the two axes of the lever determines

the travel of the piston and affects the compression ratio. "B" is a vulnerable point which should be reinforced as soon as the machine is purchased. It is advisable to order two spare sets of rollers ("c") from the outset. Or if making them oneself, use 50 Rockwell quality steel.

Some models are supplied without handle. One can find a 2 cm. long metallic tube; others are supplied with a 3 parts portable handle that is practical and well conceived

Piston: The piston is a cylinder on which is mounted a circular plate. It is guided by two adjustable angle-bars (A). Pieces of wood can be bolted onto the plate to produce special shapes (hollow blocks, grooves etc.)

TEK BLOCK

The Tek Block is a manual press developed in Ghana by the Housing and Planning Research Department* [Faculty of Architecture, University of Science and Technology, Kumasi, Ghana]. It is the same kind of machine as the Cinva-Ram except for the opening and shutting of the cover-plate which is automatic. It is easier to use and can accelerate the production rate.

The mould-box, cover-plate and compression piston are in 12 mm steel as are all movable parts. The guide-rails and lever-arm are made of wood. The machine is supplied with guide-rails, a lever-arm extension, a sieve, measuring boxes, recommendations for trying it out and an instruction booklet (fig. 221).

* Faculty of Architecture — University for Science and Technology



FIGURE 223: MAKING BRICKS WITH A TEK BLOCK PRESS (UPPER VOLTA)

Marcel Demunvick

**FIGURE 220:
THE VARIOUS PARTS
OF THE
CINVA-RAM
PRESS**

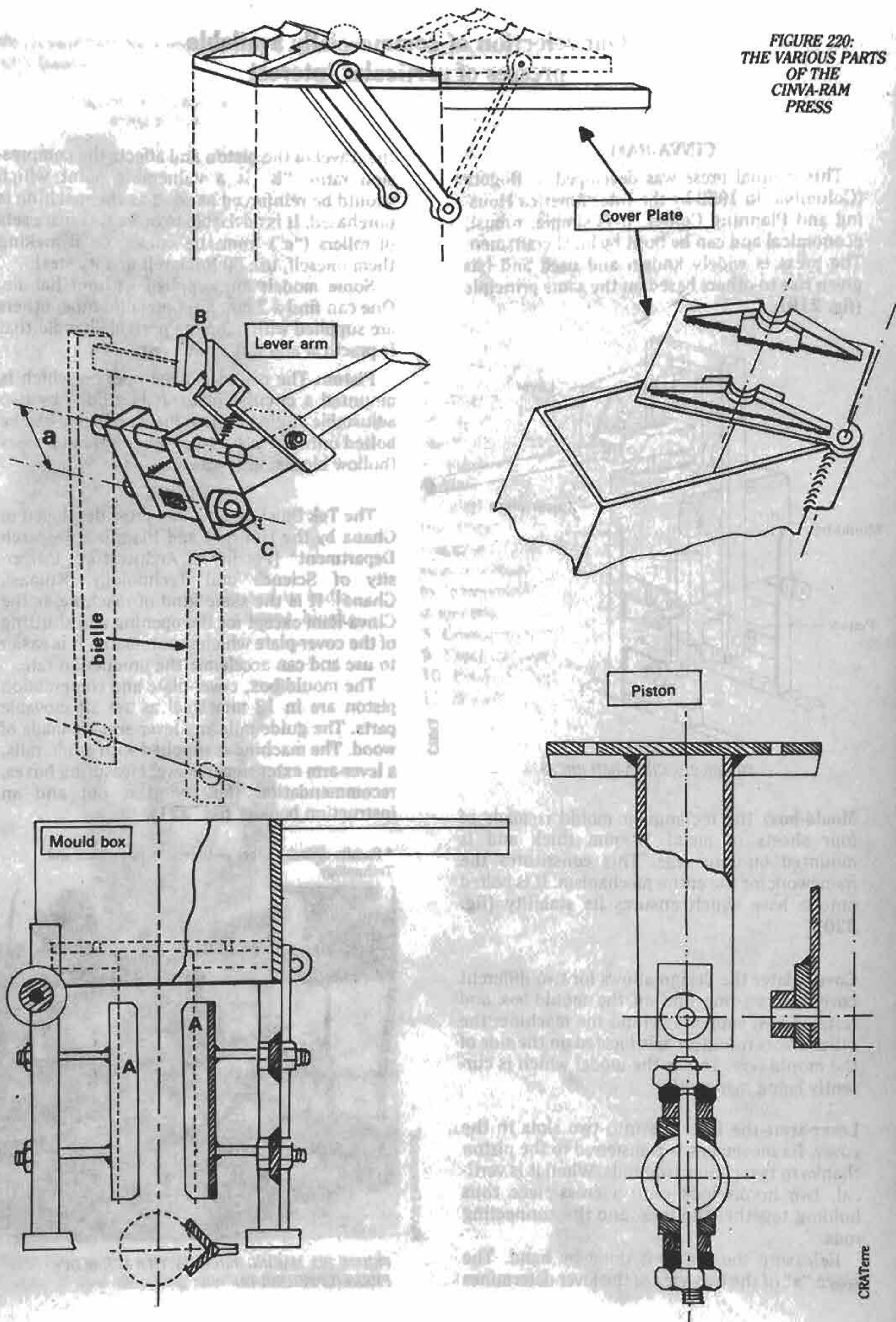

Note: if supplied by Kumasi of SAFI only the press is supplied.

FIGURE 221: TEK-BLOCK PRESS (GHANA)



ELLSON BLOCKMASTER

This manual press is manufactured in India. Four models produce various different blocks and bricks.

Description (fig. 225):

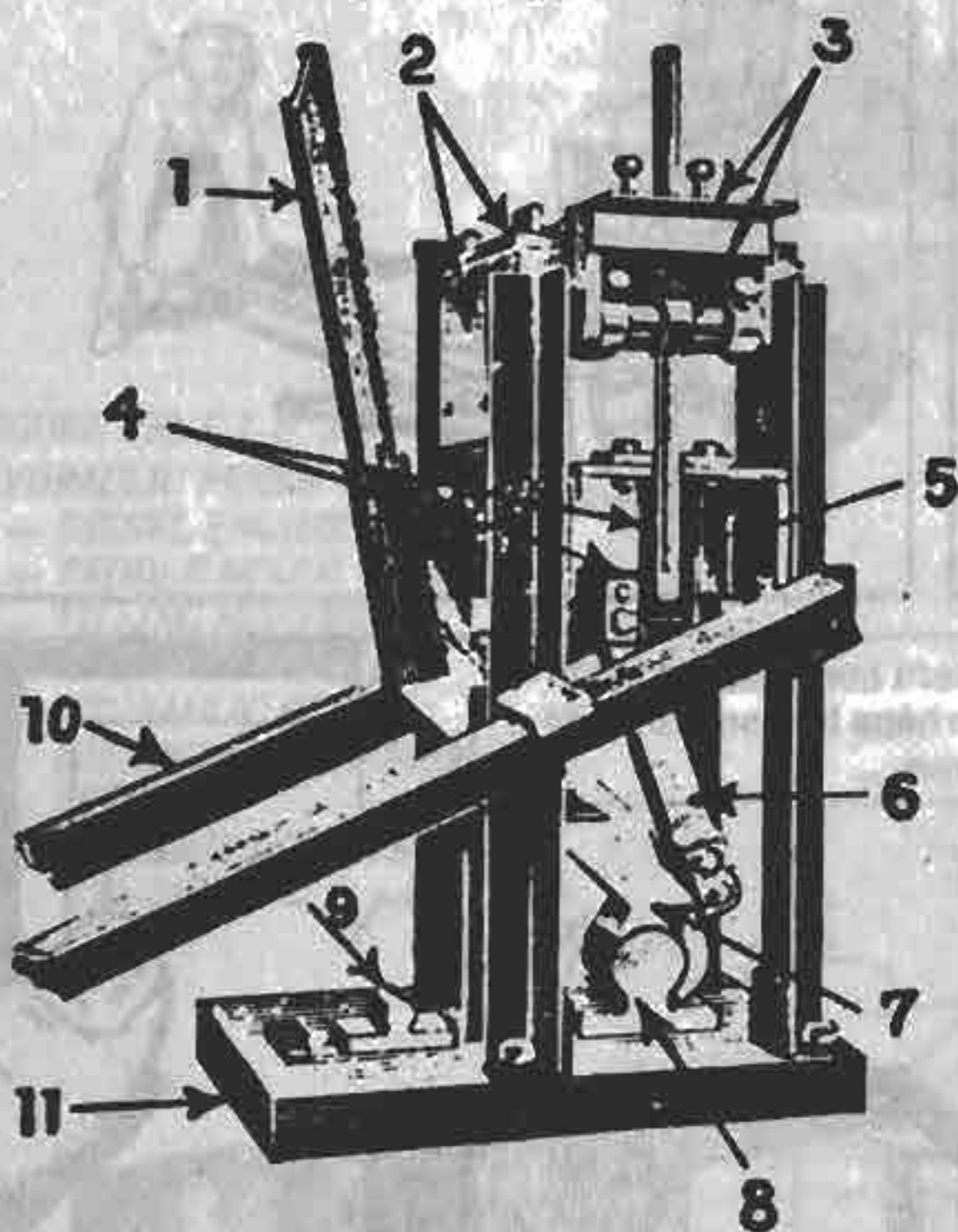

FIGURE 225: ELLSON BLOCKMASTER PRESS

1. The main lever-arm is slid into the shaft in part no. 7.
2. Mould-box and cover-plate.
3. Opening and shutting mechanism of the

cover-plate including a folding clamp and an eccentric spindle.

Use of the press:

To close: with the cover-plate lowered, lift the clamp with one hand at the same time raising the lever of the eccentric spindle with the other. Holding the clamp in position, lower the spindle as far as possible to hold the cover-plate down.

To open: Lift the lever of the eccentric spindle; this releases the clamp which has then only to be folded towards the front to free the cover-plate.

4. Piston transom: two sliding cross-pieces which travel between the guide-rails (no. 5) which direct the piston.

5. Guide-rails.

6. Main connecting-rod driving the piston.

7. Lever with claw joint which pivots on no. 8 at the time of compression. When the lever is stopped by the second pivot (no. 9), compression is complete. The cover is then opened and by lowering the lever as far as possible the brick is ejected.

8. Compression pivot.

9. Ejection pivot.

10. Props ensuring the stability of the press.

11. Stand.

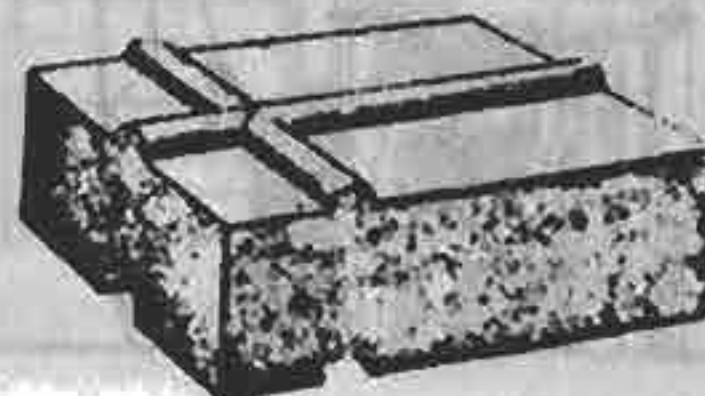
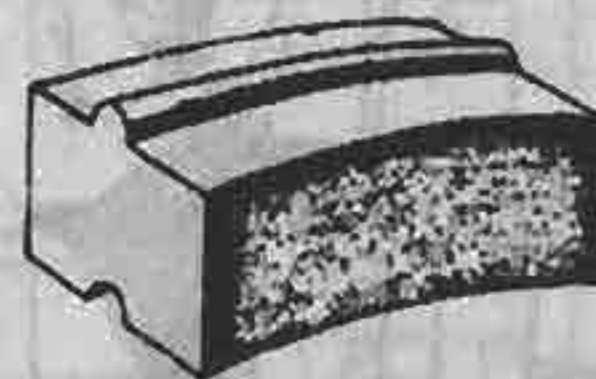
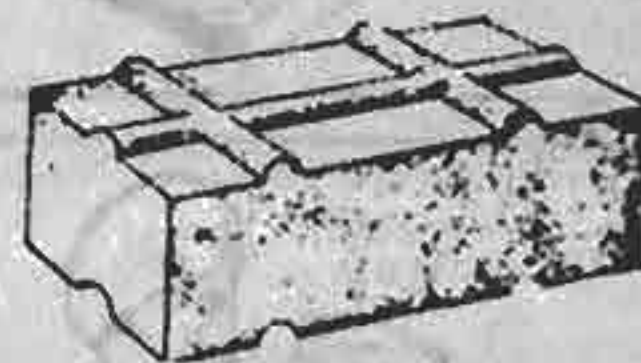
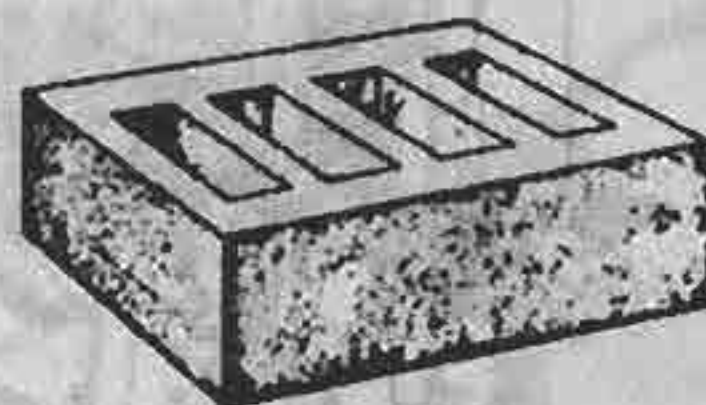

FIGURE 225A: THE VARIOUS BRICK SHAPES POSSIBLE TO BE PRODUCED WITH THE ELLSON BLOCKMASTER.

A brick press at work: the "Blockmaster"

First of all a good dose ...



of earth ...

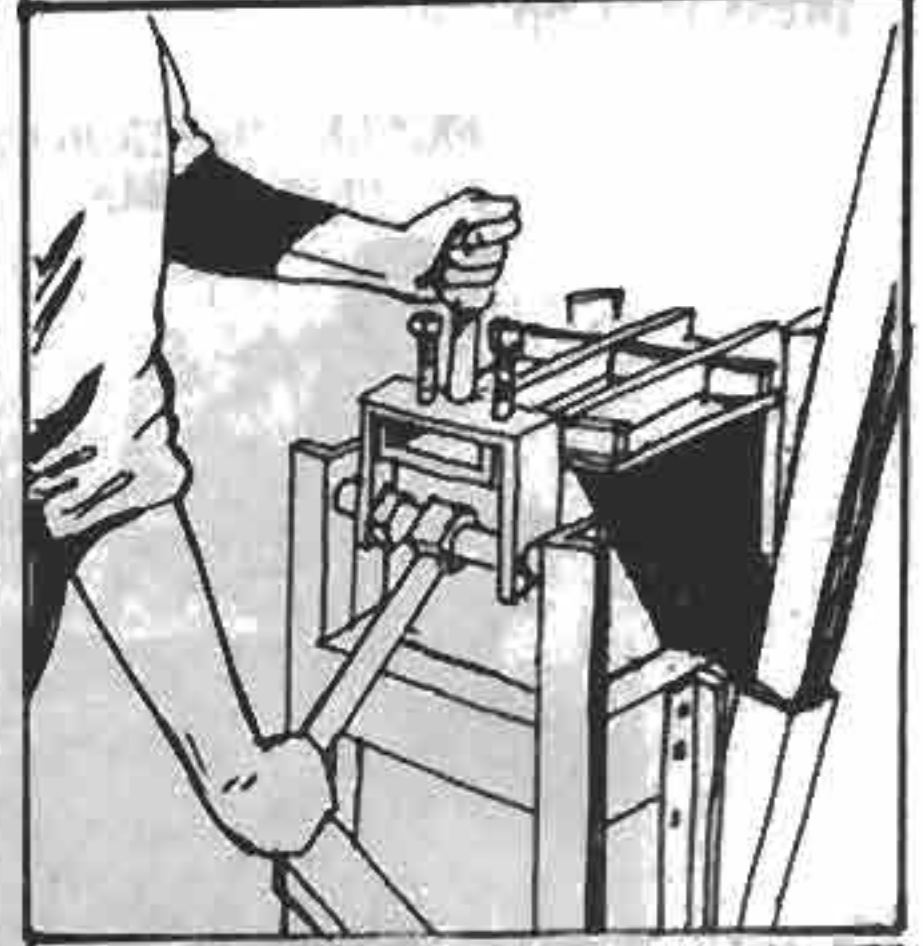

Once the box is full, the cover-plate is closed and bolted.

The lever-arm is pulled down (without any great effort) making the

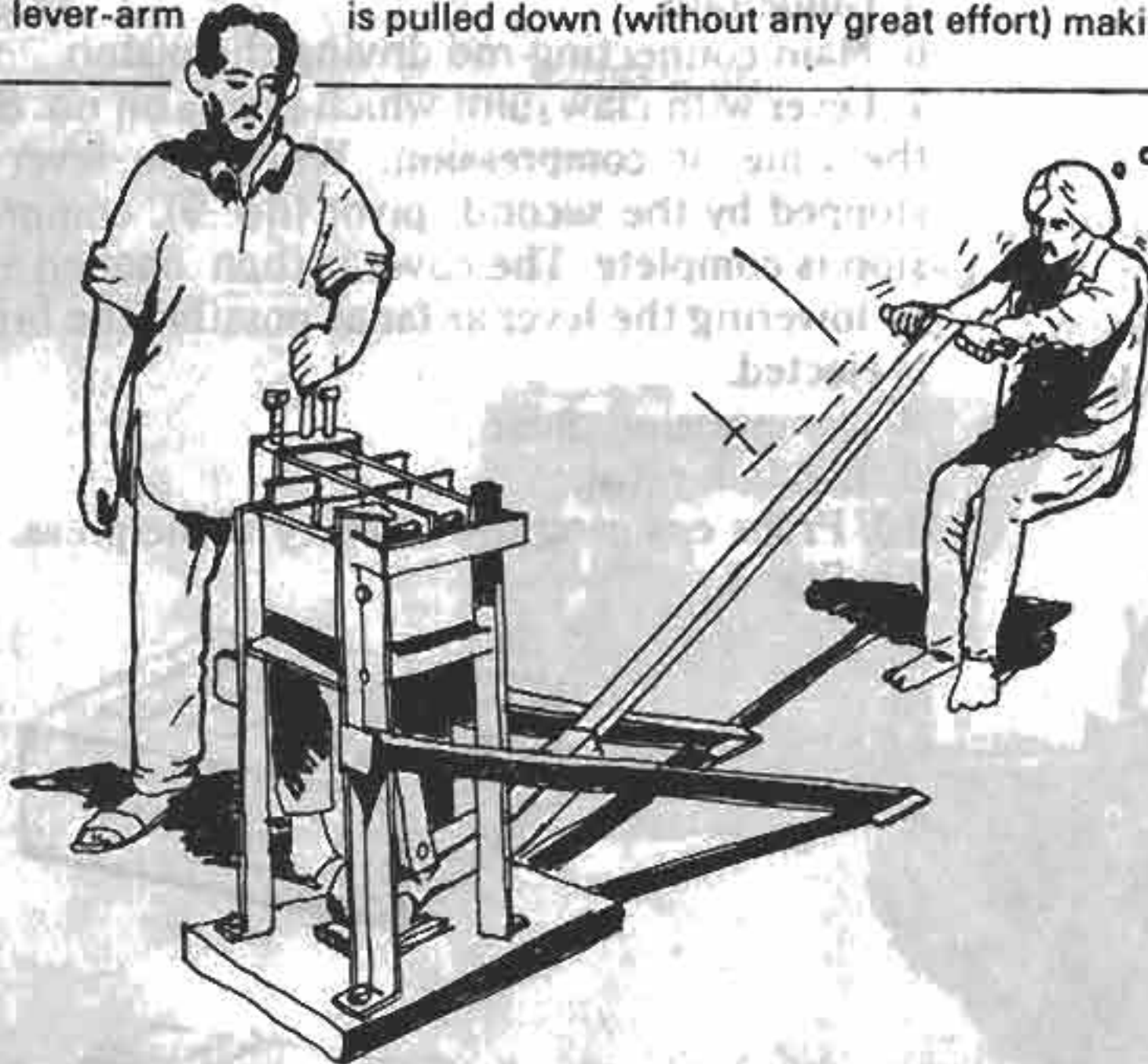

Piston rise in the mould-box, and the cover-plate is unbolted and opened up ...

and the lever-arm lowered as far as possible to eject the brick.

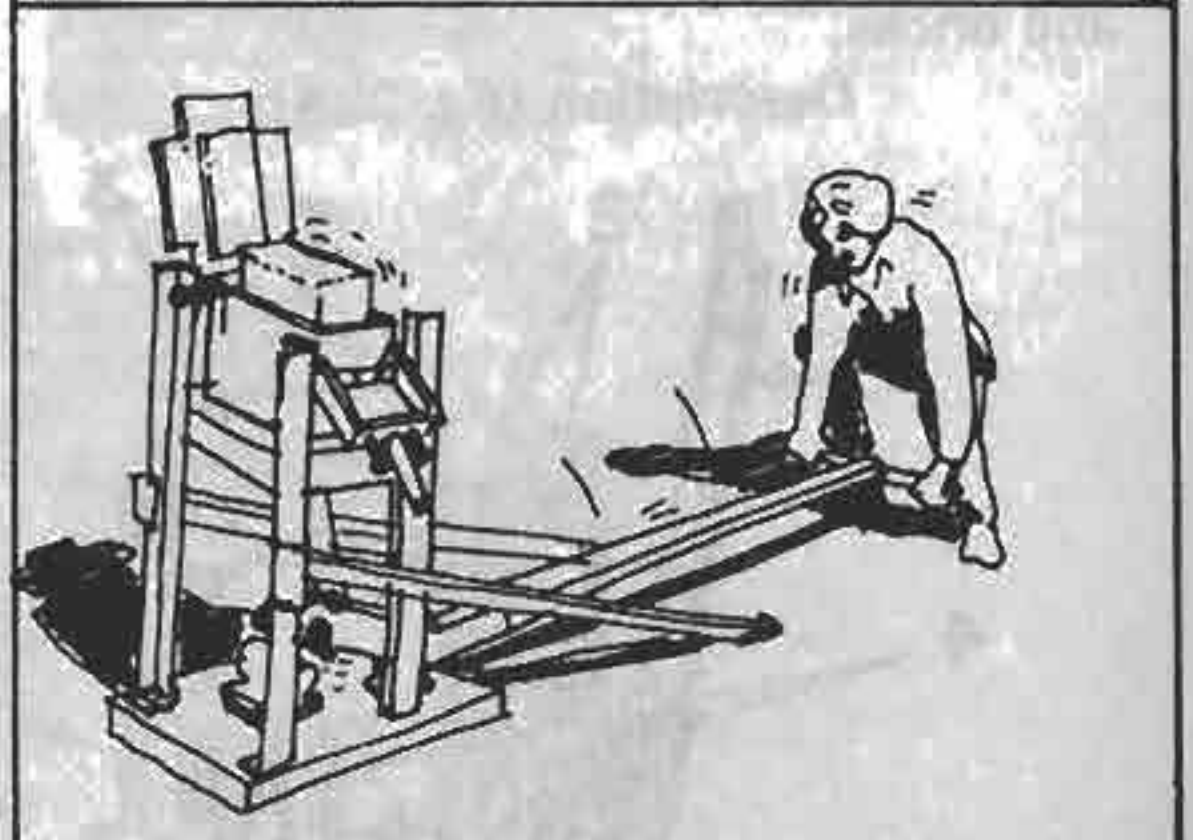

And there you are! A magnificent compressed earth brick which, when dry, will perhaps be used to build one of these splendid bungalows ...

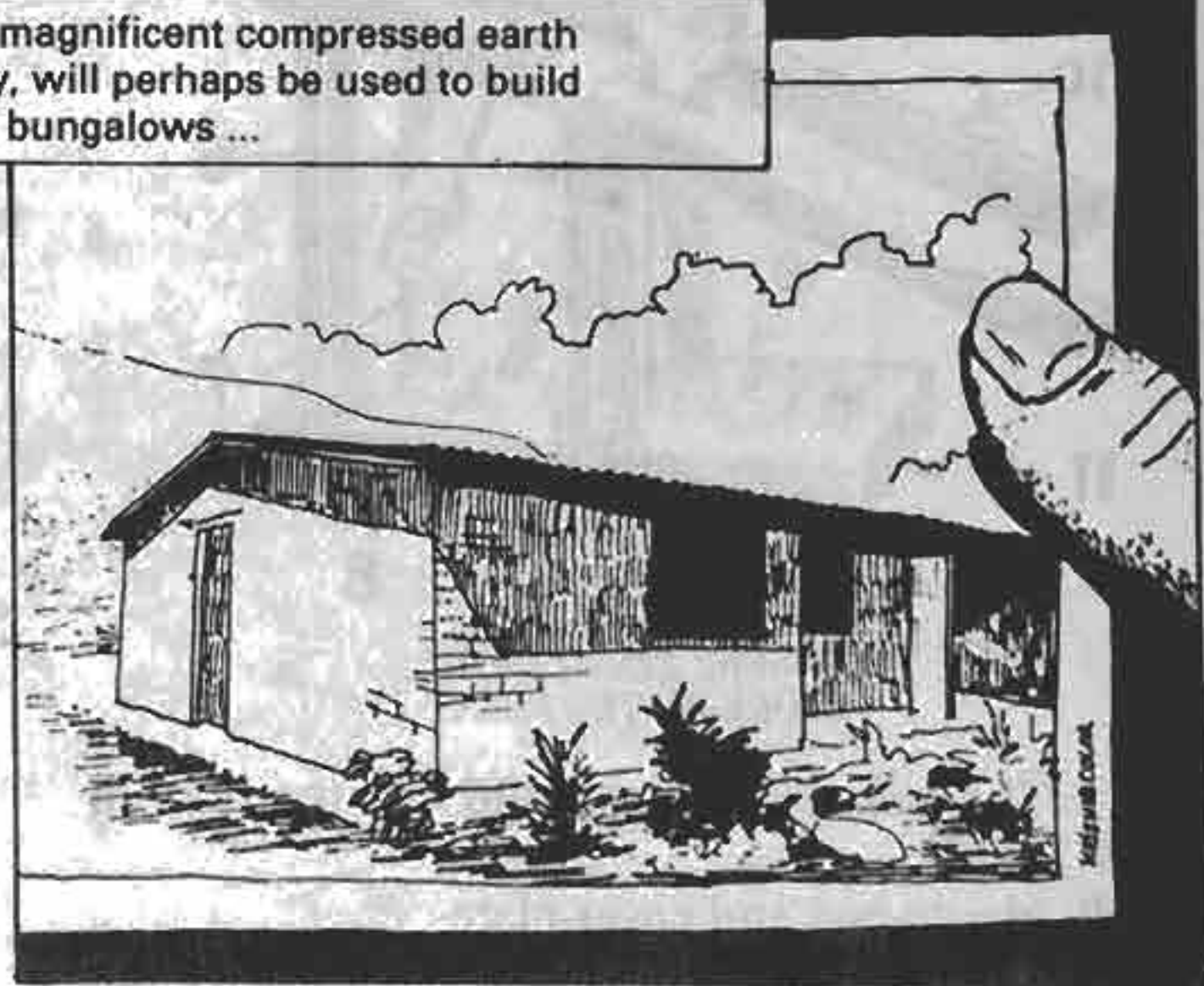
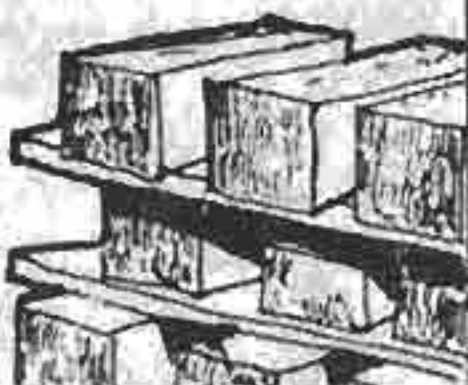

"TERSTARAM"

This manual press (figs. 228-229) is sometimes known as the "Landcrete" or "Stabibloc" press. It is currently being improved and this

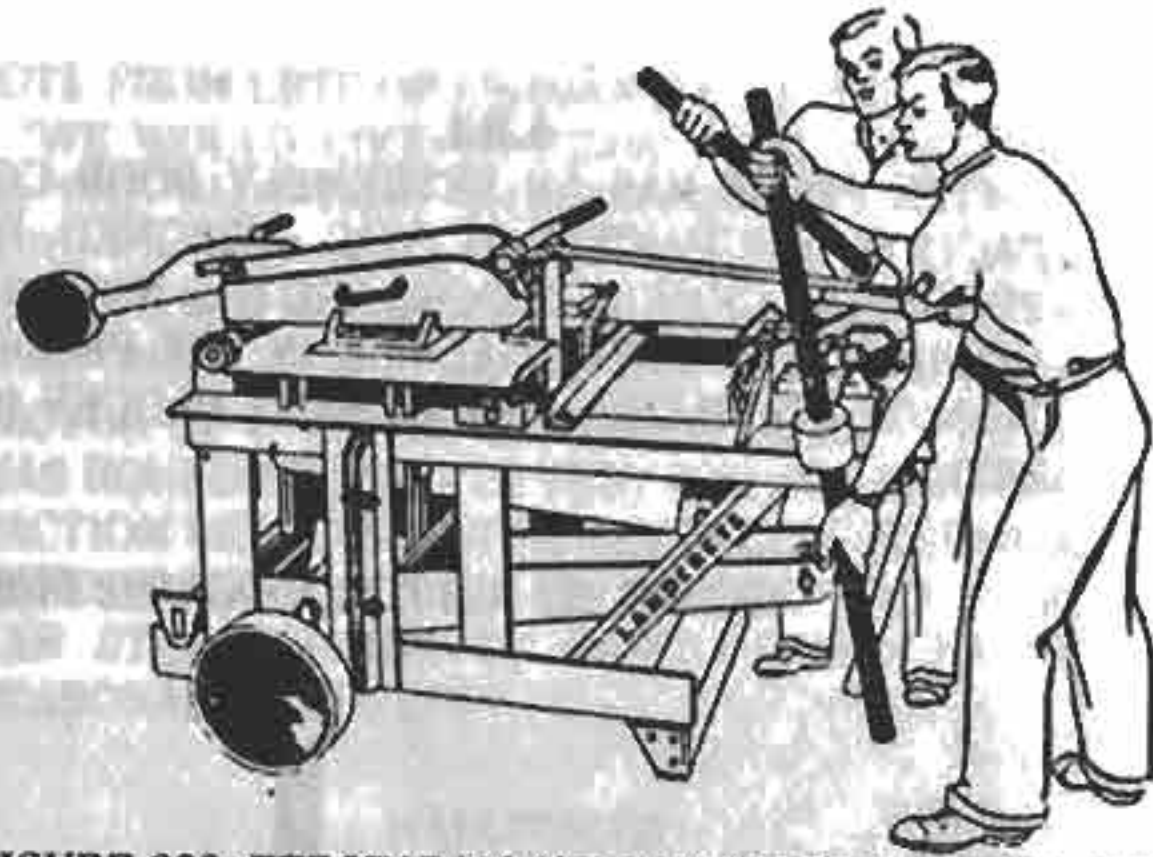

FIGURE 228: TERSTARAM (OR LANDCRETE) PRESS. THE OPERATOR RESPONSIBLE FOR FILLING THE MOULD-BOX AND REMOVING THE BRICK ALSO HELPS WITH THE COMPRESSION.

will make it the best manual press available on the market.

Its main advantages are:

- high pressure,
- interchangeable moulds,
- resilience,

- tool box,
- precompaction thanks to hinged cover-plate.

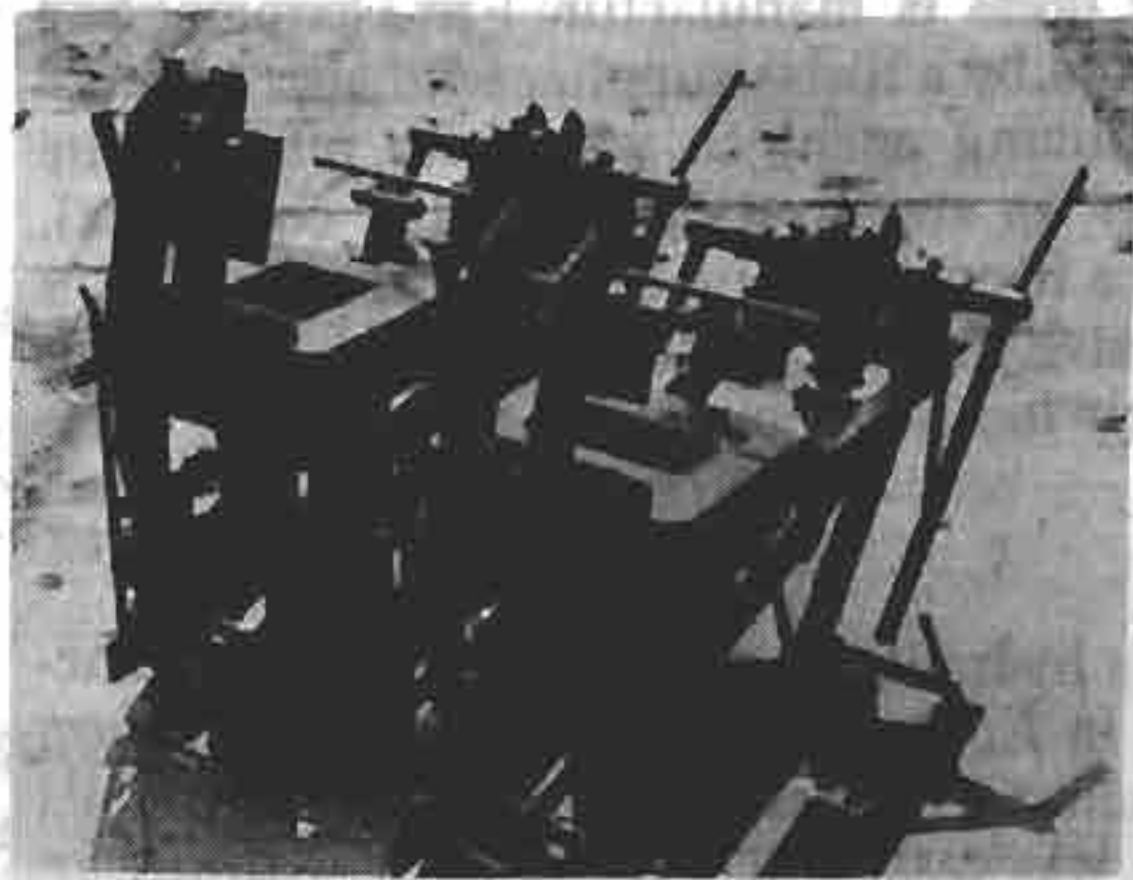

FIGURE 229: TERSTARAM PRESS. AS IT WINDS ROUND THE SPINDLE, THE CHAIN PULLS UP THE LEVER WHICH DRIVES THE PISTON.

C.L.U. 2000

This hydraulic press (fig. 230) with a revolving plate has two original features: it is fitted with a mixer with a horizontal axis and a capaci-

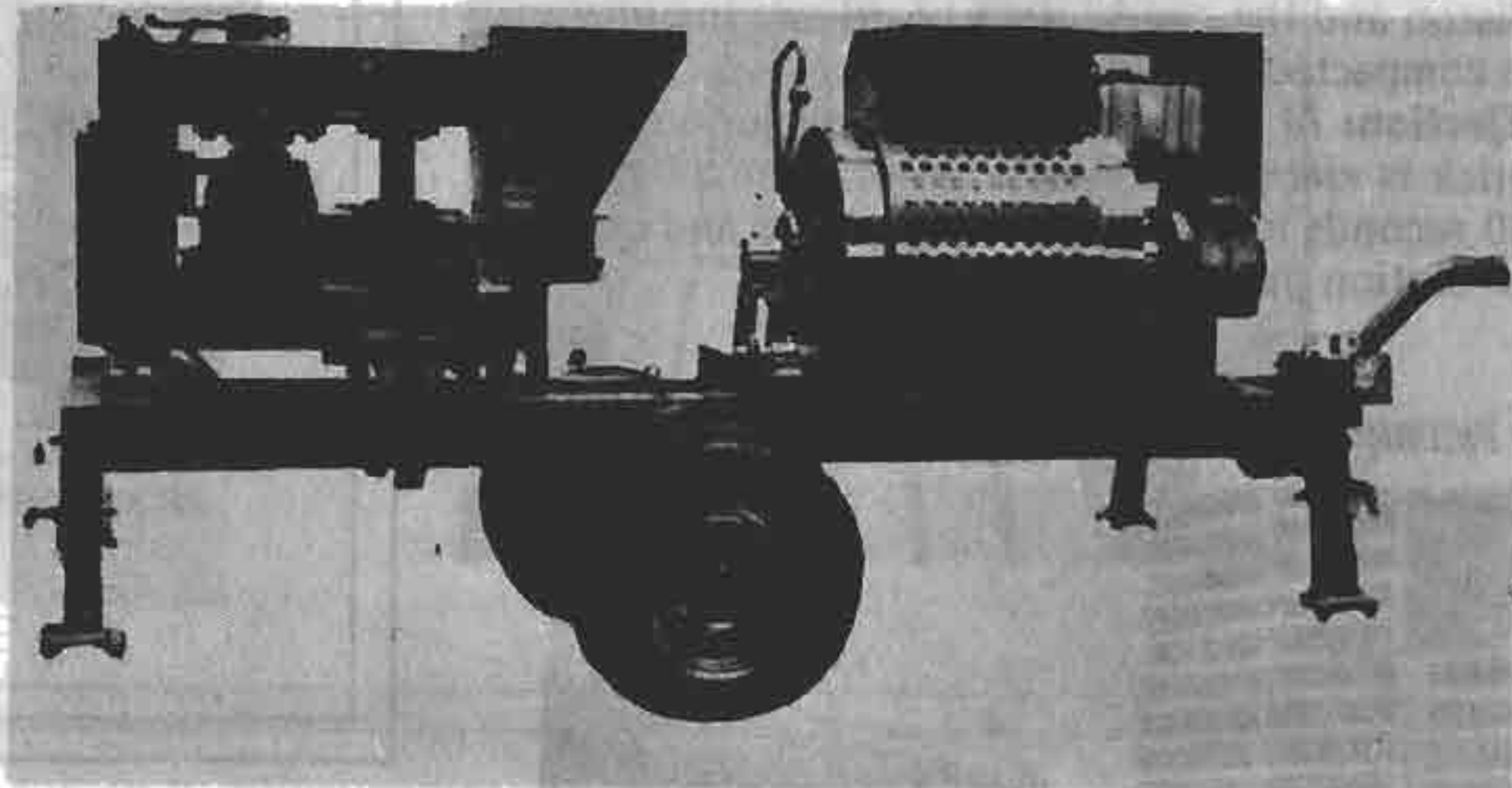
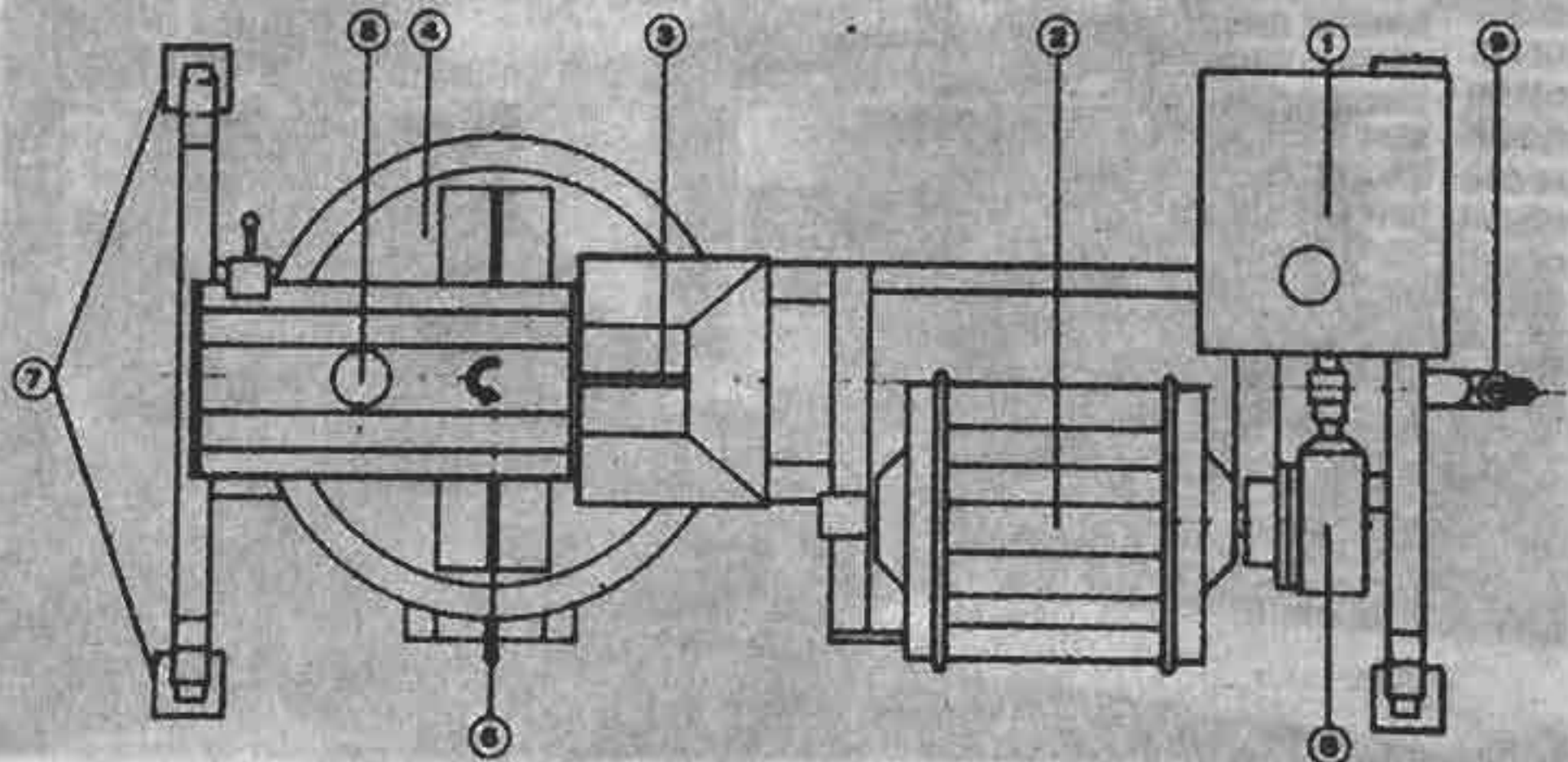

FIGURE 230: C.L.U. 2000 HYDRAULIC PRESS

- 1 - DIESEL ENGINE
- 2 - PADDLE MIXER
- 3 - FILLING HOPPER
- 4 - REVOLVING PLATE
- 5 - HYDRAULIC PRESS
- 6 - EJECTION MECHANISM
- 7 - LEGS
- 8 - TRANSMISSION SYSTEM
- 9 - TOW-BAR



ity of 140 litres, and it is mounted on a trailer with tyres which makes it easy to move around.

The press is manufactured in Germany and marketed by a Swiss supplier who also supplies a stabilizing agent to which we refer in the chapter on stabilization (consolid, conservex). Despite its original and attractive features, it is expensive and its output poor, making it unlikely to be economically viable.

M.M.H. 2000

This hydraulic press (fig. 231) was manufactured in England in 1976 for an English firm producing chemicals. A prototype, the MMH 4000, was tested in Mauritania by ADAUA for over a year in very severe conditions. It was thanks to this prototype that it was possible to develop a viable machine, the MMH 2000.

Principle used: the machine is fitted with a revolving plate. In the course of one revolution, the mould is filled, compression takes place, and the brick is ejected.

Filling the mould: the earth is shoveled in and fills the first mould.

Compaction: the plate turns through one third of a revolution, the mould is moved between the piston and the compaction board and the brick is compacted.

Ejection: At the next one-third revolution, the brick is ejected. The plate takes approximately 40 seconds to complete its revolution and each revolution produces three bricks.

FIGURE 231: MMH 2000 PRESSES

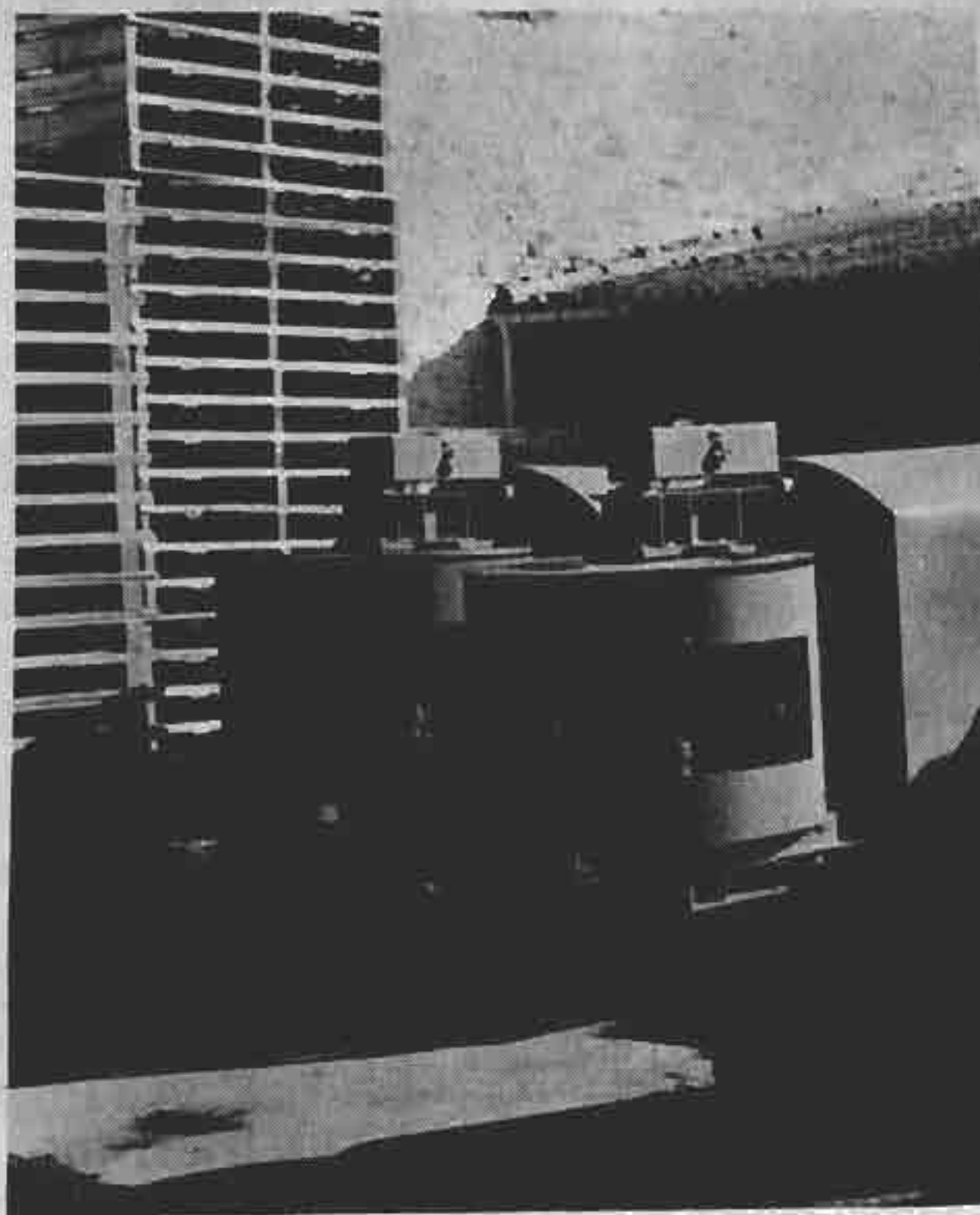

OTHER

A.B.I.

THIS PRESS HAS AN EXTREMELY POOR COMPACTION MECHANISM. IT WAS DESIGNED FOR PRODUCING CEMENT BLOCKS AND HAS NOT BEEN MODIFIED FOR POTENTIAL USE IN THE PRODUCTION OF STABILIZED SOIL CEMENT BLOCKS (fig. 232).

FIGURE 232: A.B.I. CEMENT MIX PRESS

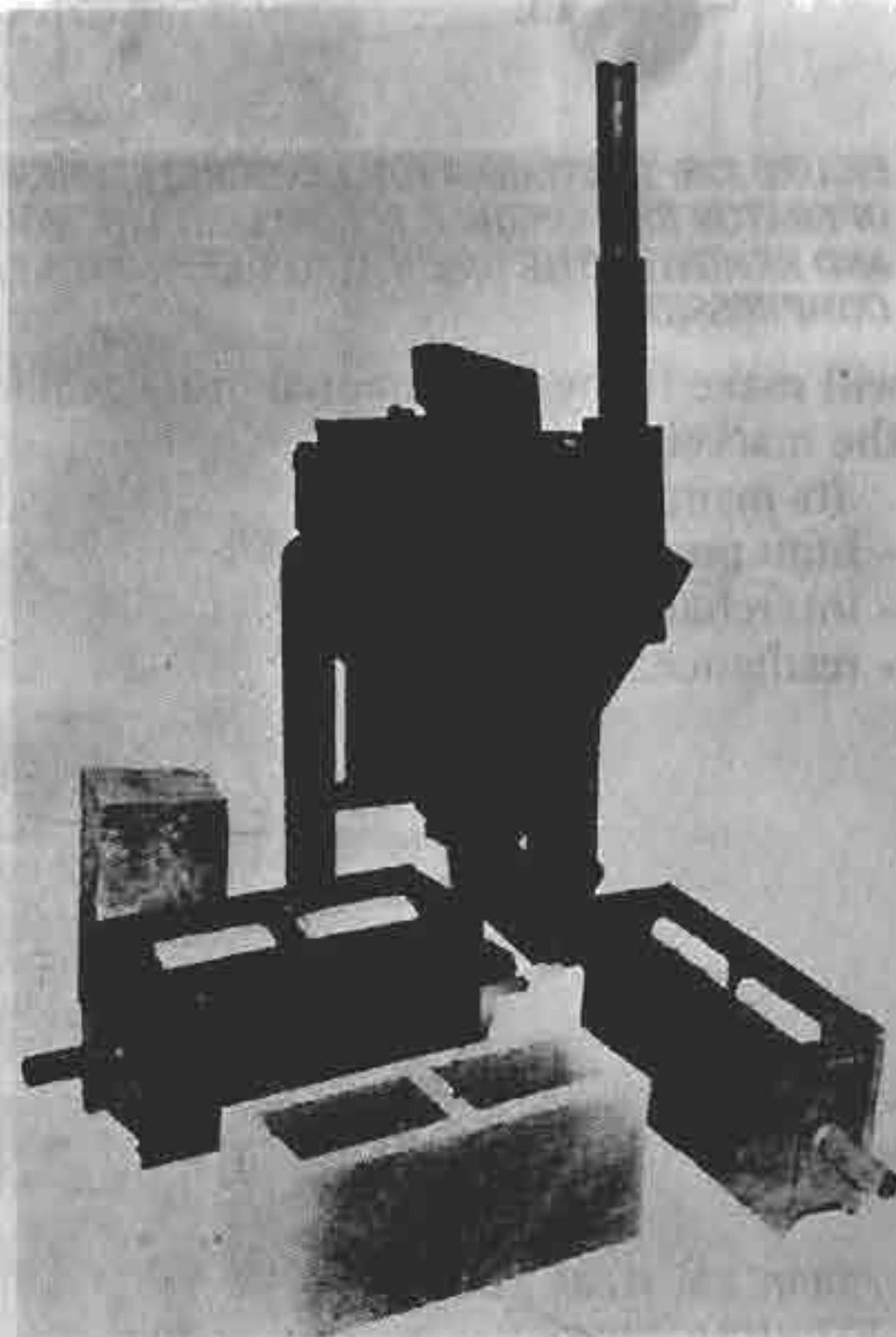

COMMERCIALLY AVAILABLE PRESSES

NOTE FROM LBTP OF ABIDJAN (14/11/78)

"WE WOULD LIKE TO DRAW YOUR ATTENTION TO THE FACT THAT THE GEOMETRICAL STRUCTURE OF THE A.B.I. ONLY ALLOWS A STRESS AMPLIFICATION FACTOR OF 12, WHICH WHEN COMPARED WITH THE STRESS AMPLIFICATION FACTOR OF OVER 150 OF THE CINVA-RAM PRESS, WAS BOUND TO LEAD TO VERY INADEQUATE COMPACTION RESULTS. NATURALLY IF CONSIDERABLE HAND-PRECOMPACTION IS CARRIED OUT, ONE CAN STILL MANAGE TO PRODUCE BLOCKS OF REASONABLE QUALITY."

HALLUMECA

NOT HAVING HAD THE OPPORTUNITY TO FAMILIARIZE OURSELVES WITH THIS PRESS, WE LACK

FIGURE 233: HALLUMECA MECHANICAL PRESS

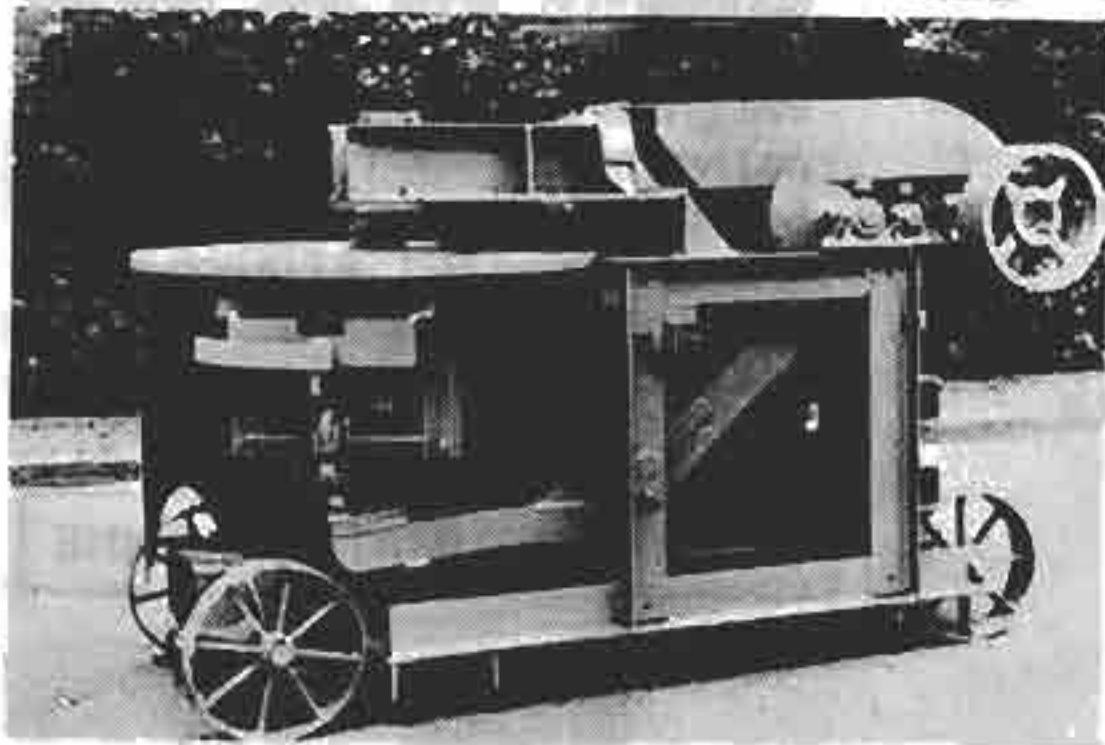

Hallumeca

INFORMATION ON IT (fig. 233). IT IS A MECHANICAL PRESS WITH POTENTIAL FOR EASY ADAPTATION TO THE PRODUCTION OF EARTH BLOCKS.

DROSTHOLM L3

THIS PRESS IS SOLD COMPLETE WITH A STABILIZATION PROCESS (LATOREX) AND FORMS PART OF A FACTORY PRODUCTION LINE. TWO HAVE BEEN INSTALLED, BUT HAVE NOT BEEN VERY SUCCESSFUL (fig. 234).

FIGURE 234: DROSTHLM L3 PRESS

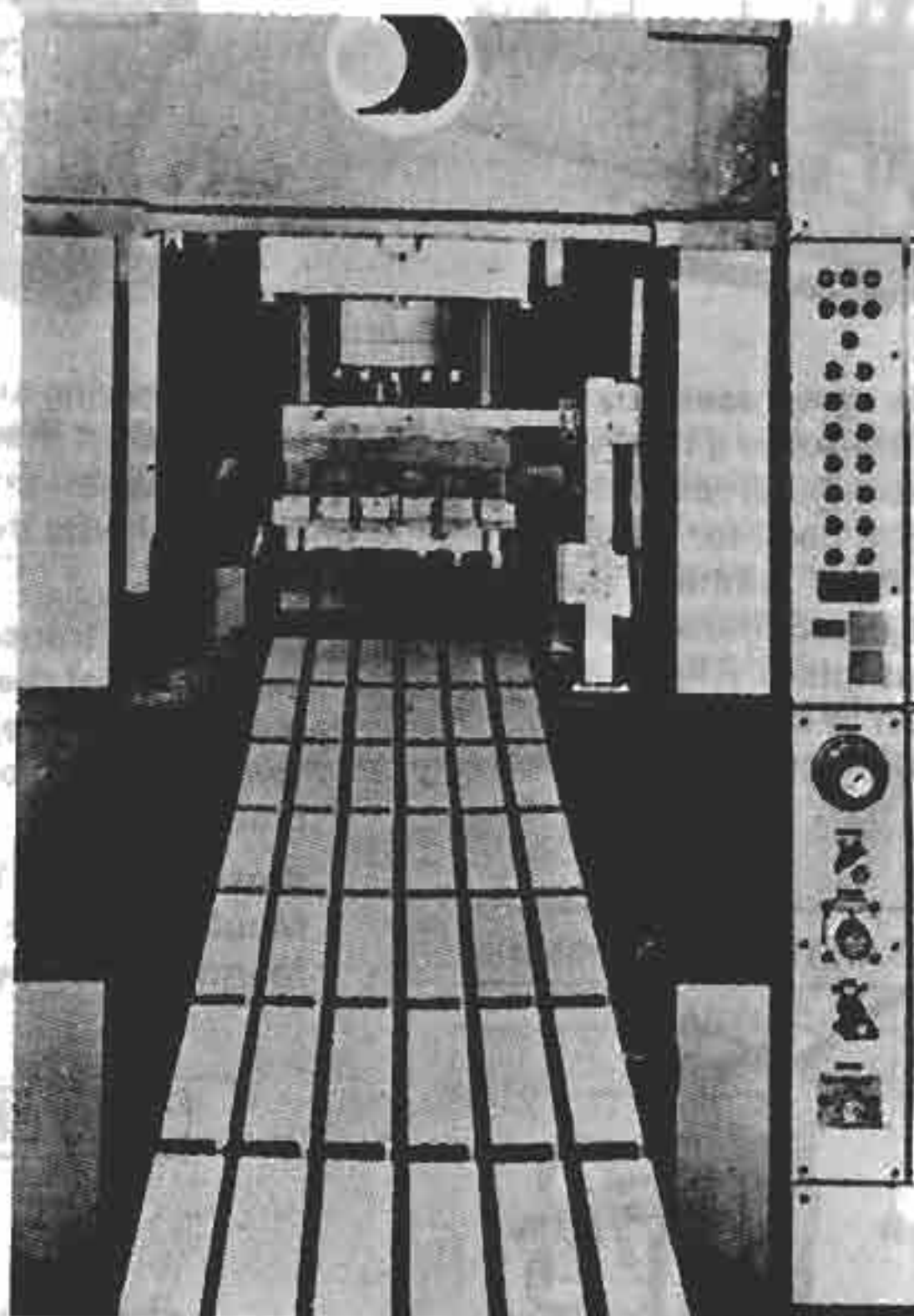

Drostholm

PRODUCTIVITY OF AVAILABLE PRESSES

Production	Type of press	Daily production (blocks)	Factory price (FF)	Net weight (kg)	Pressure applied to the material (kg F/cm ²)	Presses available
Low	manual	300 to 1,200	1000 to 4000	63 to 290	7 to 20	- ABI - TEKBLOCK - CINVA RAM - ELLSON BLOCKMASTER SM et TERSTARAM
Medium	Hydraulic	2000 to 2800	45000 to 70000	1500	20 to 40	- MMH 2000 - CLU 2000
High	Mechanical	8000 to 16000	35000 to 65000	1500		- HALLUMECA B 75, B 100, B 150, B 200
Very high	Hydraulic	10000 to 72000	200 000 to 9000000	10000 to 16000	20 to 60	- DROSTHOLM L3

The press museum

NO. 1 LEVER MACHINE

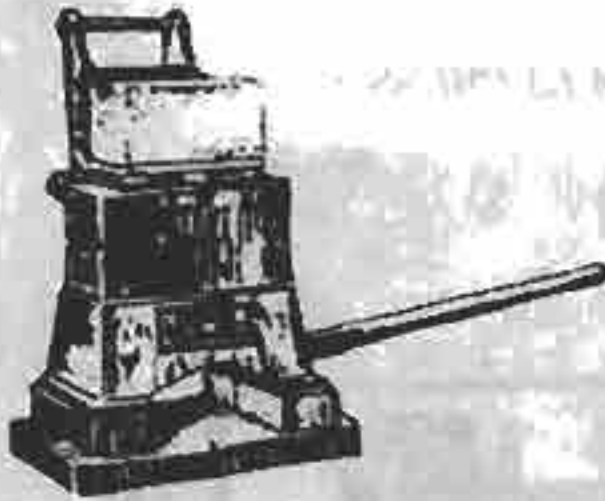

The mix is compressed by tamping thanks to a heavy cover-plate which removes some of the need for tamping with the small rammer. The block is ejected thanks to a rising base-plate. Allows production of one block at a time. Manufactured by Bonnet.

PM LEVER PRESS

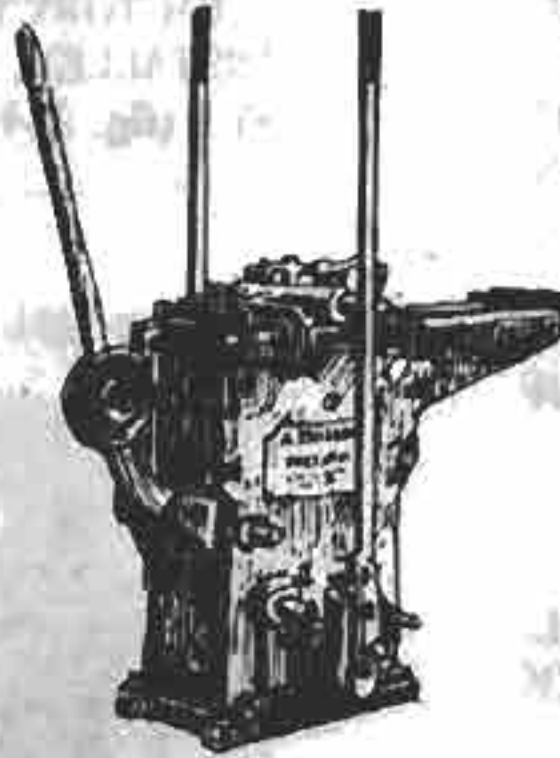

Press applying simple direct compression thanks to an elbowed shaft and a connecting rod which lifts the compression piston.

Two levers transmit the movement of the elbowed shaft. A second lever ejects the block. Two operators, one block at a time.

Pressure: 10 to 15 kg/cm².
Mould-box: 20 x 20 x 40.
Manufactured by Thiebault.

RAPIDE NO. 5 PRESS



Lever-arm driver with returning springs.

Labour: one or two operators. Weight of press, fitted with one or two moulds and rammer, boxed, 345 kg. Manufactured by the Franco-Alsacian Company.

HOURDA TYPE C MACHINE

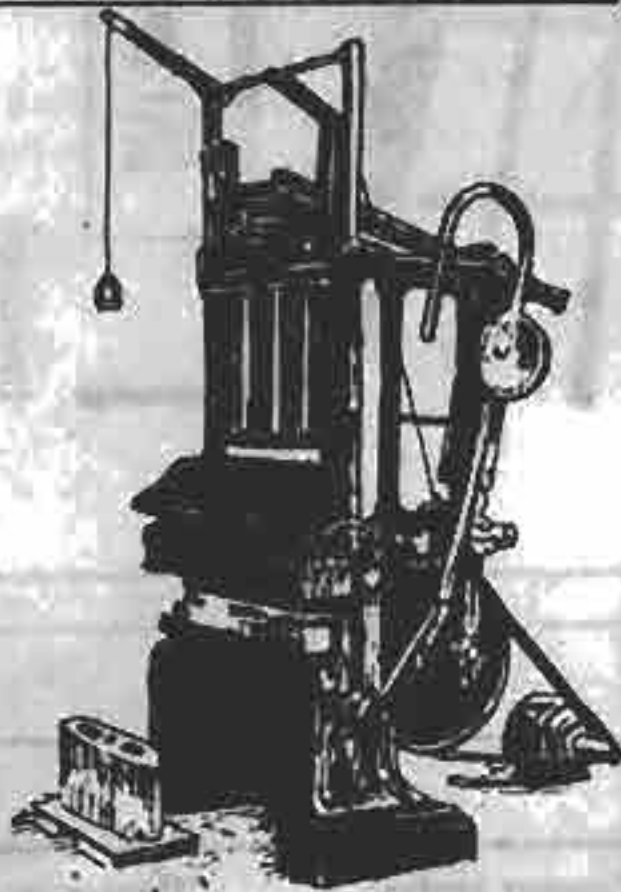

Motor-driven rammer. The pressure is based on the principle of a small pile-driver (friction-belt and moving plate). Dry strike.

Moulds filled in two or three operations and several strike. Moulds rise to eject blocks. Maximum size of blocks produced: 70 x 30 x 25. Power needed: 2.5 HP. Weight ready for shipping: 1,850 kg. Manufactured by Bonnet.

NO. 1 DAMETTE

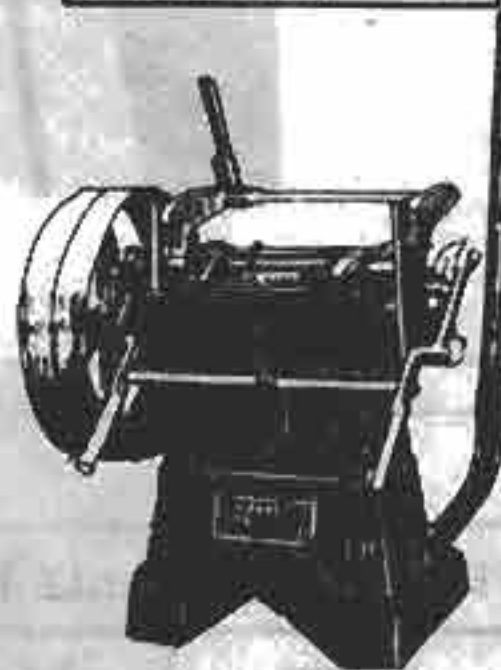

Motorized mixing machine. Compaction achieved by a 90 kg rammer driven by a cam; one block at a time.

Power needed: 2 HP. Weight ready for shipping: 1,000 kg. Manufactured by Bonnet.

TYPE 810 PNEUMATIC MACHINE

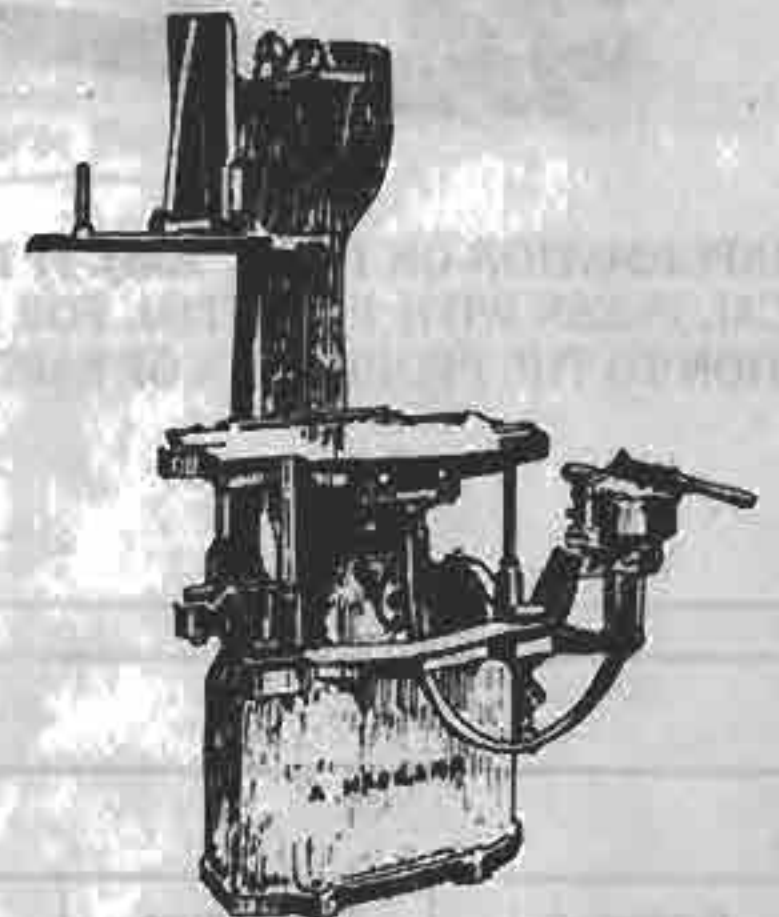

This type of machine, used for production of foundry moulds, should be suitable for earth compaction, if a compressor is available. The table is joined to a 16 cm diameter piston driven by compressed air (6 to 7 kg). Inside the piston a moving mass can complete the action of the piston by striking the underside of the table at a rate of up to 800 blows per minute. At the top, the facing-plate is held vertically and laterally removed. Power needed for compressor: 3 HP. Weight: 400 kg.

"Here are some examples of presses which are no longer on the market ... but which might spark off some ideas!"



Manufactured by Marillier.

CRATerre

A project for
brick-yard in

Type PBB Lever Rammer

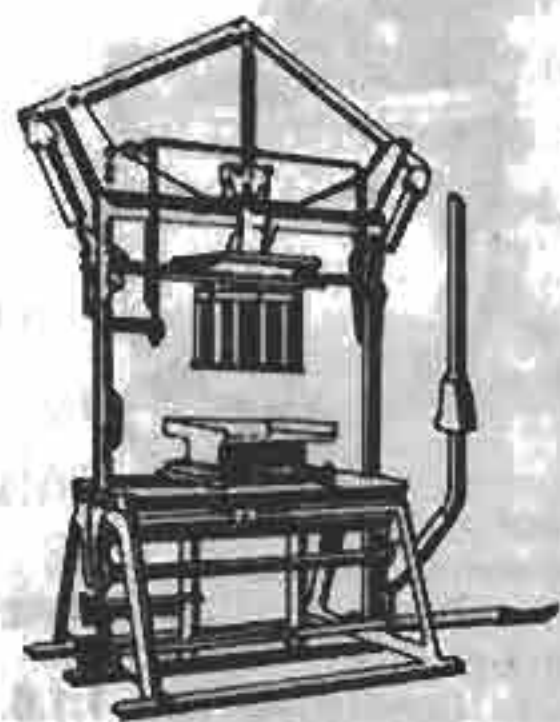

Rammer with lever arm with returning springs
Labour: 1 or 2 operators
Net weight: 500 kg
Manufactured by Bonnet.

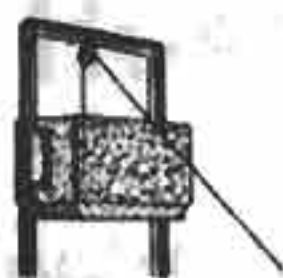

System D Guided Rammer



The blow depends on the principle of a pile driver guided by two side-pieces.
Mould: 30 x 15 x 25
Extracted from System D Selections no. 23

Canada Guided Rammer

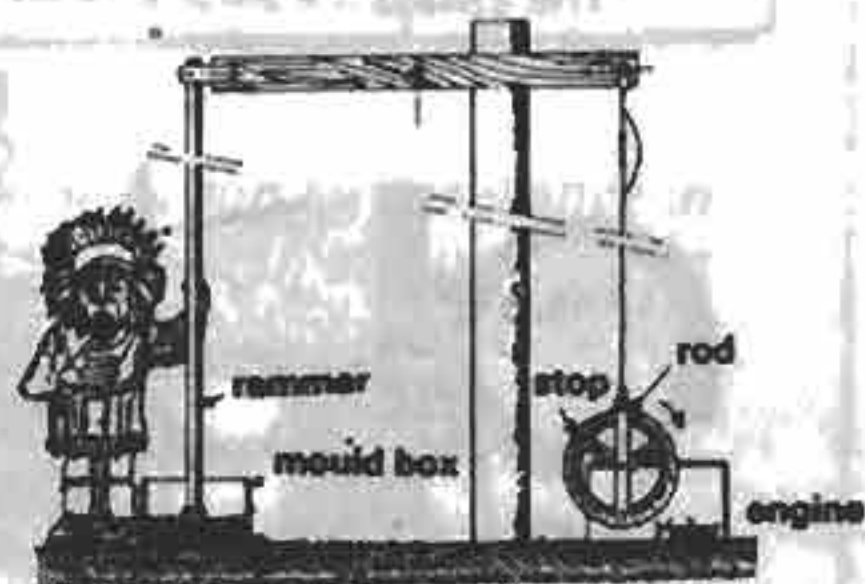

The operator guides the rammer across the whole surface of the earth-filled mould. The rammer strikes 75 blows per minute. It takes approximately 4 minutes to produce one block.
University of Saskatchewan — Saskatoon, Saskatchewan

Wooden Press

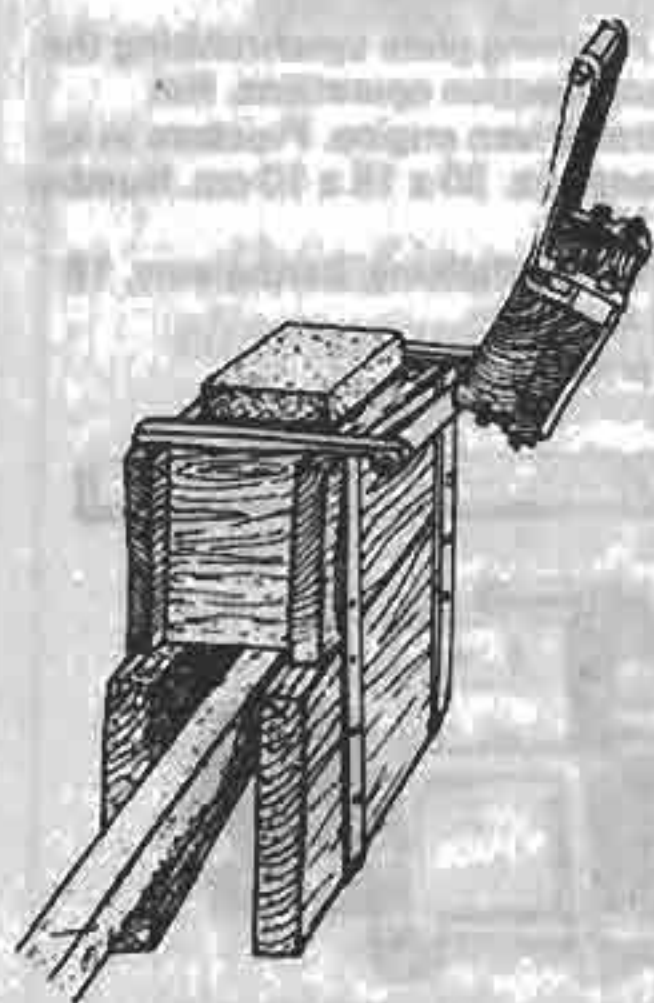

Designed by the BIT of Dakar and used in West Africa.

"Hercules"



Press fitted with soldered steel lever arm; was delivered with moulds allowing production of bricks 20 x 107 x 70 mm, other shapes were available and there were also moulds enabling one to produce floor and roof tiles, half pipes ... The precursor of the SM, Lancrete, Terstaram ... Villers Perwin.

Curer Press

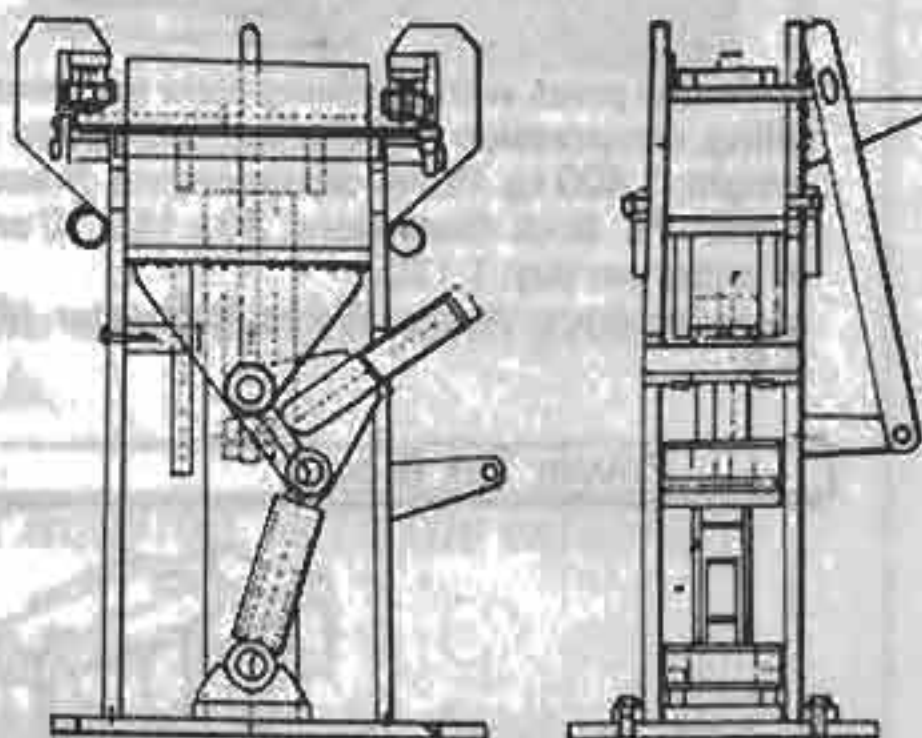

Designed at the University of Constantine, Algeria.
Prototype. Size (l x w x h) 38 x 48 x 75 cm. Net weight: 100 kg. Pressure in kf F/cm²: 10 to 20. Compression ratio: 1 : 1.28. Max. depth of mould: 120mm. Max. travel of plate: 30mm. Brick dimensions: 25 x 12 x 9.8. Daily production rate: 300. Number of operators: 2.

The "Majo"

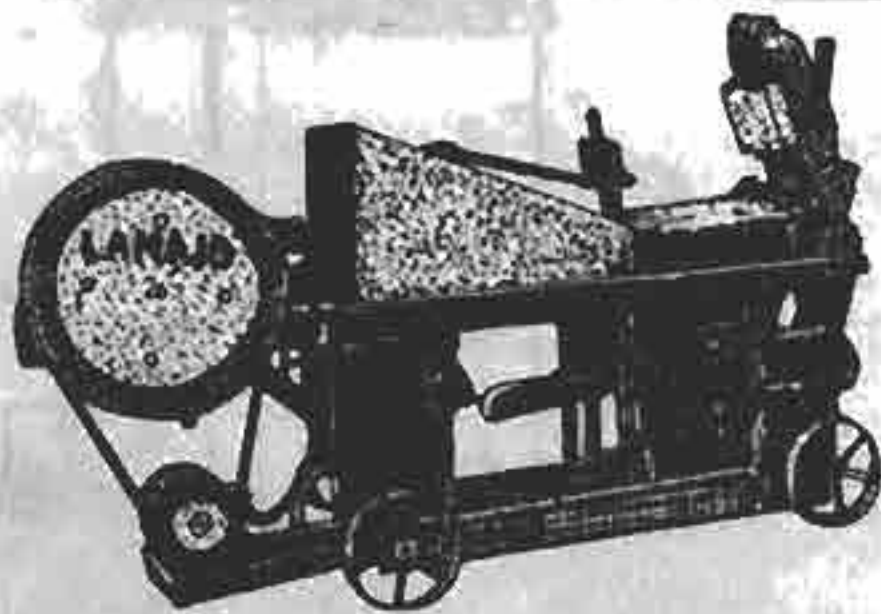

Motorized mechanical press completing the compression and ejection operation in 2.5 seconds. production thus depends on the time taken to fill the moulds and remove the bricks. Dimensions (1 x w x h) 66 x 200 x 108 cm. Net weight: 720kg. Electric or petrol-driven motor. Compression ratio: 1: 1.65. Bricks: 9.5 x 14 x 8.8 cm. Daily production rate: 9,600. Max depth of mould: 145 mm. Max. travel of plate: 50mm. Manufactured by Villers Perwin.

The "Majomatic"

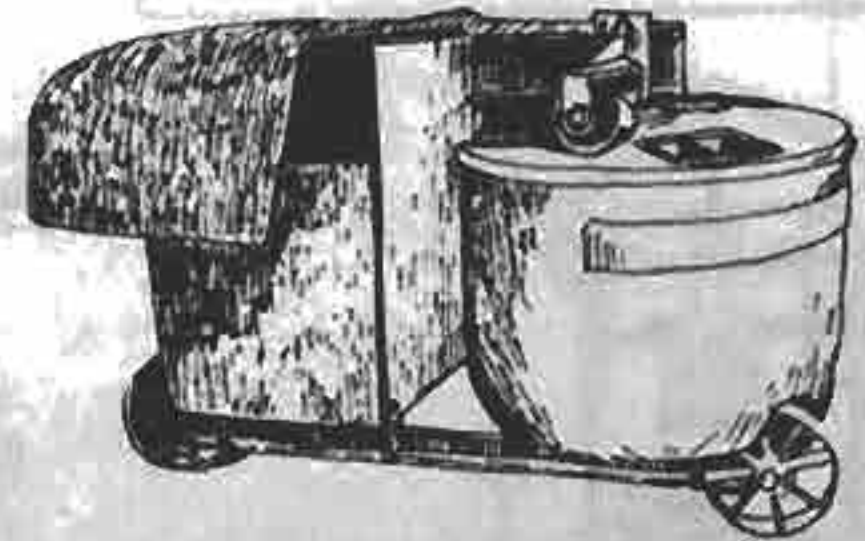

Mechanical press with revolving plate allowing synchronized filling, compression and ejection. Dimensions (1 x w x h): 66 x 200 x 120 cm. Net weight: 1,500 kg. Motor: Petrol-driven — 3 HP — 1 litre/hr; Diesel — 5.5 HP — 1.5 litre/hr. Compression ratio: 1:1.6. Bricks: 30 x 23.5 x 8 cm. Daily production: 4,000. Max. depth of mould: 128 mm. Max. travel of plate: 48 mm. Number of operators: 3. Manufactured by Villers Perwin. Similar to the Hallumeca press.

Winget

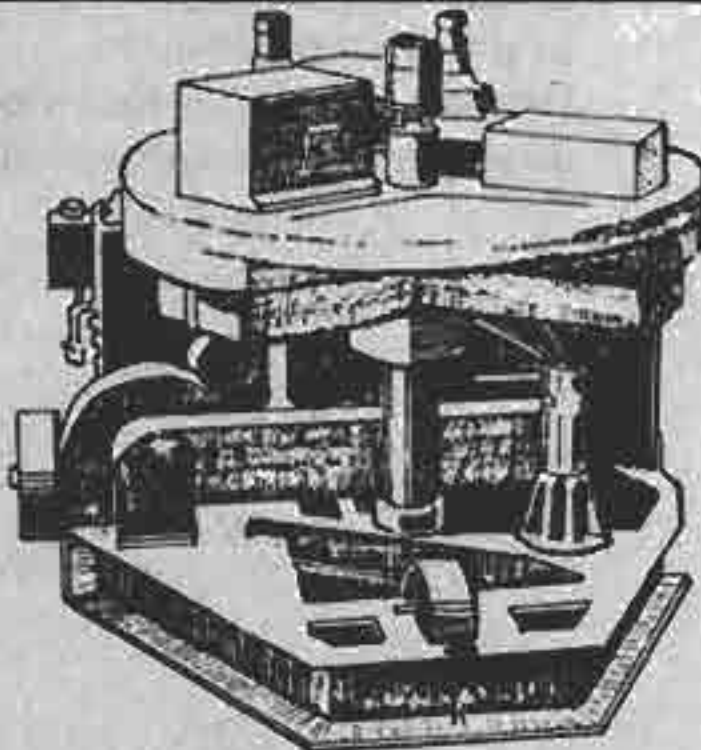

Hydraulic press with revolving plate synchronizing the filling, compression and ejection operations. Net weight: 1,800 kg. Petrol-driven engine. Pressure in kg F/cm²: 75. Brick dimensions: 30 x 15 x 10 cm. Number of bricks per day: 1,120. Manufacturers: Winget Works, Rochester, ME2 4AA, G.B.

10P11P

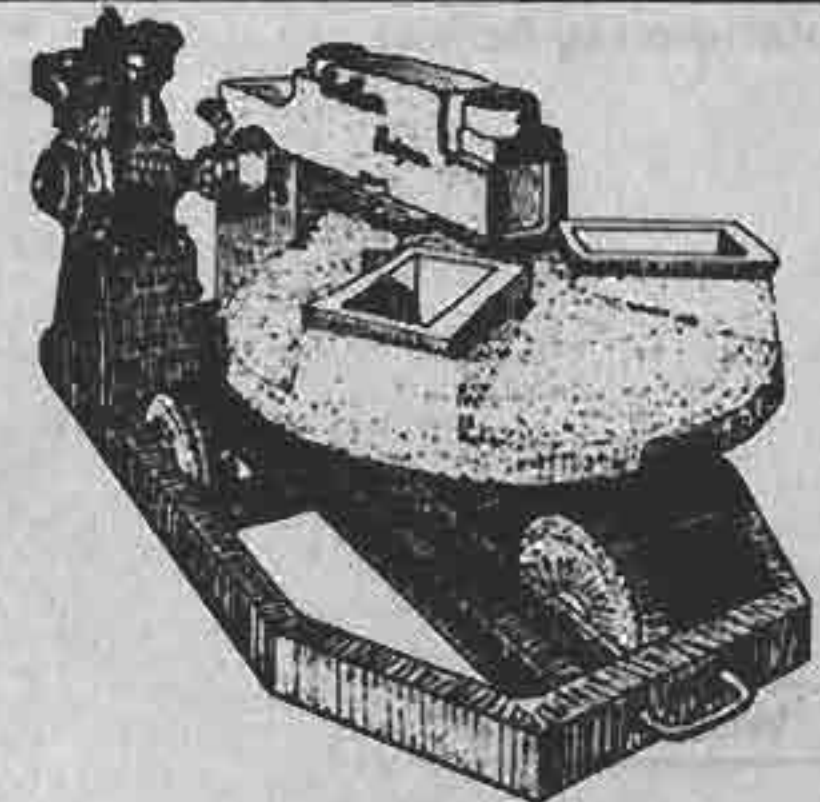

Hydraulic press with revolving plate synchronizing the filling, compression and ejection operations. Net weight: 1,800 kg. Petrol-driven engine. Pressure in kg F/cm²: 75. Brick dimensions: 30 x 15 x 10 cm. Number of bricks per day: 1,120. Manufacturers: Guilhon Barthelemy, Barthelemy, 18 Rte de Montfavet, 84 Avignon. Same as the Winget press. Only one model built.

Power Tek Block

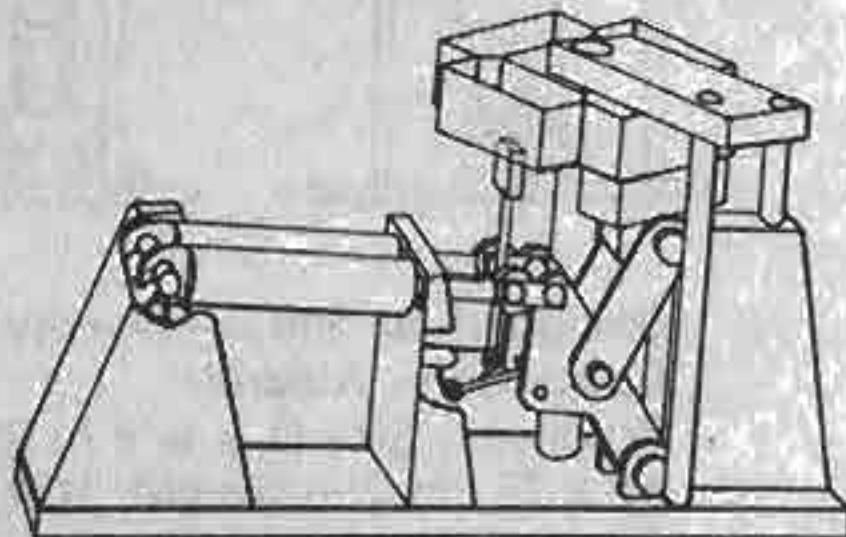

Hydraulic press with revolving plate synchronizing the filling, compression and ejection operations. Dimensions (1 x w x h) 56 x 113 x 56 cm. Pressure in kg F/cm²: 24. Brick dimensions: 30 x 22 x 15 cm. Production: 2,000 per day.

MMH 4000

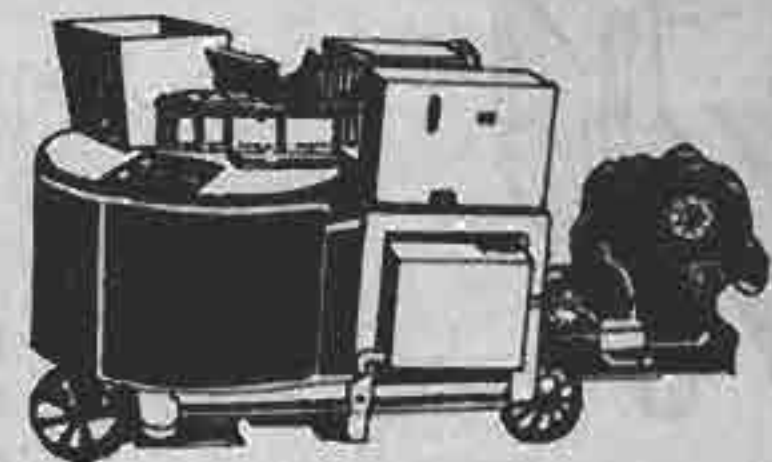

Hydraulic press with revolving plate synchronizing the filling, compression and ejection operations. Dimensions (1 x w x h) 100 x 230 x 150 cm. Net weight: 1,200 kg. Bernard 20 HP diesel-powered motor. Compression ratio: 1:2.8. Max. depth of mould: 225 mm. Max. travel of plate: 120 mm. Brick dimensions: 29.5 x 14 x 8.8 cm. Production: 4,000 per day. Manufacturer: Villers Perwin. Only one prototype built.

A project for setting-up a brick-yard in Rosso (Mauritania)

To illustrate this technique we asked ADAUA, the African institution for assistance in matters relating to housing, to present the project undertaken at Rosso in a slum area, in the context of a vast popular housing and urban regeneration programme amongst the population of Satara (figs. 238, 239, 240).

FIGURE 238: ON SITE AT ROSSO (MAURITANIA).

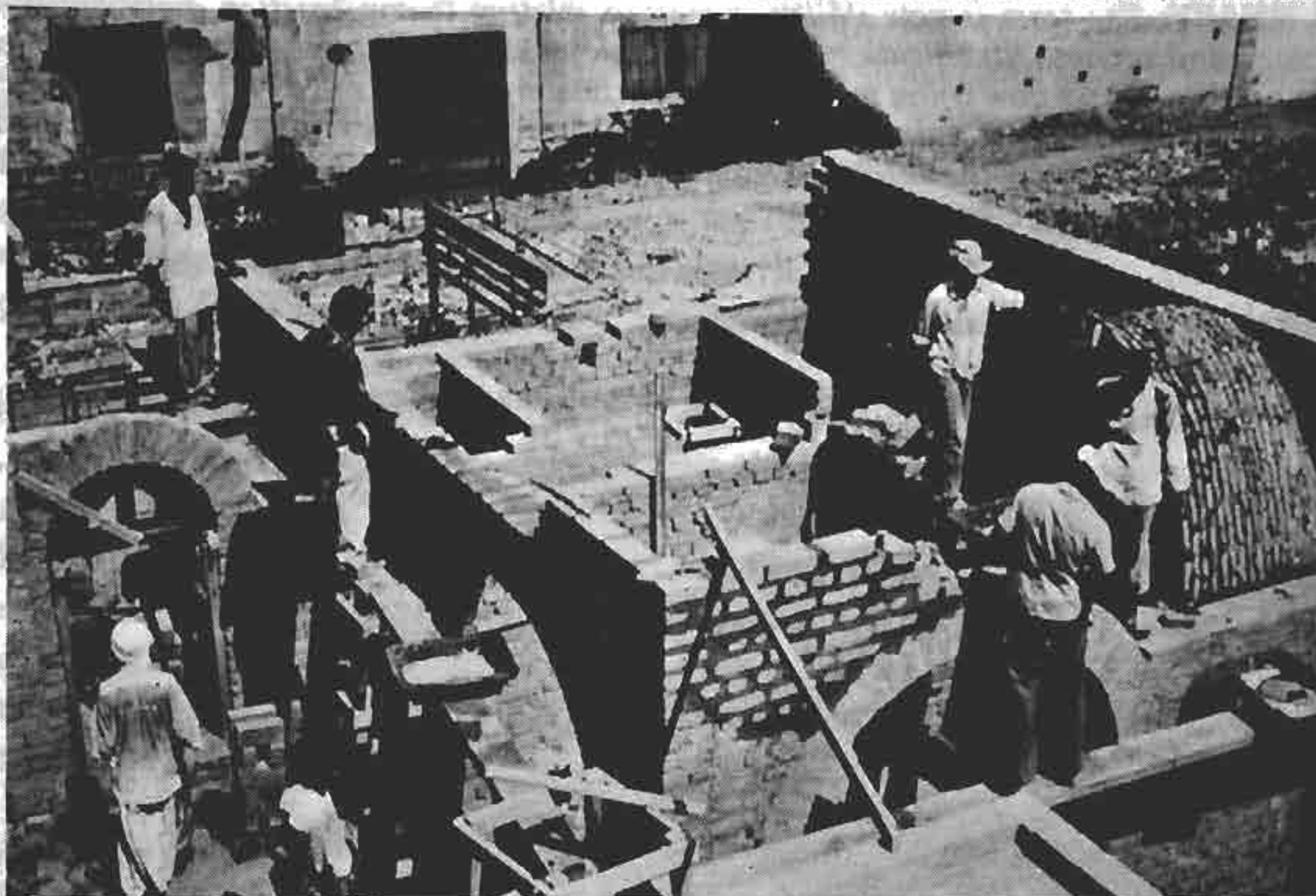

ADADA

Objectives:

- Use of improved local materials, financially accessible to the most underprivileged, and eliminating dependence on imported and inadequate materials.
- Training of labour-force on these new techniques.
- Creation of jobs in the course of the programme for popular housing, with the establishment of builders' and craft cooperatives.
- Creation of production units (brick-yard), with training of labour force.
- Dissemination to the populations concerned, notably through a popular fund, of the techniques for improved housing through assisted self-help.

The studies, researches and new technical achievements undertaken by the workshop collective established and particularly by the materials workshop, led to -

- The setting-up of a brick-yard for sun-dried bricks, using the various soils found in the country with stabilizers. Needless to say these superior quality materials correspond to the economic, social, and climatic conditions of the area and their cost price is substantially lower than that of ill-suited imported materials.
- The use of new techniques borrowed from ancient housing construction techniques of the Sudan and the Sahara: vaults and domes.

The local materials workshop

Two African engineers and a trainee technician made up the workshop team. From the very first the problem was to find soils and to achieve a mix of sand/clay and water which would satisfy certain standards from the very first brick. A manual brick-making press, the CINVARAM, enabled the production of compacted bricks. A S.M., also manual, was used to produce good quality stabilized full bricks, and hollow bricks for site tests of the first vaults, arches and domes.

Thanks to a prototype hydraulic press, the MMH 4000, 4,000 very strong stabilized blocks per day were produced. This press led to the development of the robust and viable MMH 2000 press.

The laboratory was set up and the training of an assistant to analyze soils, carry out compression tests and check the soil mixes from various excavations began.

SUMMARY: The team is now skilled in matters relating to construction, notably vaults, domes and arches. Stabilization and the brick-making machines are giving excellent results. The bricks now being made cost approximately half the price of the cement bricks currently used in Mauritania and are superior to them in quality. Water no longer has any detrimental effect on the bricks. Insulation tests indicate a degree of thermal comfort compatible with the climate of the area.

Currently under study:

- 1) Stabilization of natural and local products;
- 2) Renders and paints;
- 3) Stabilized and perforated bricks (testing of vaults and domes).

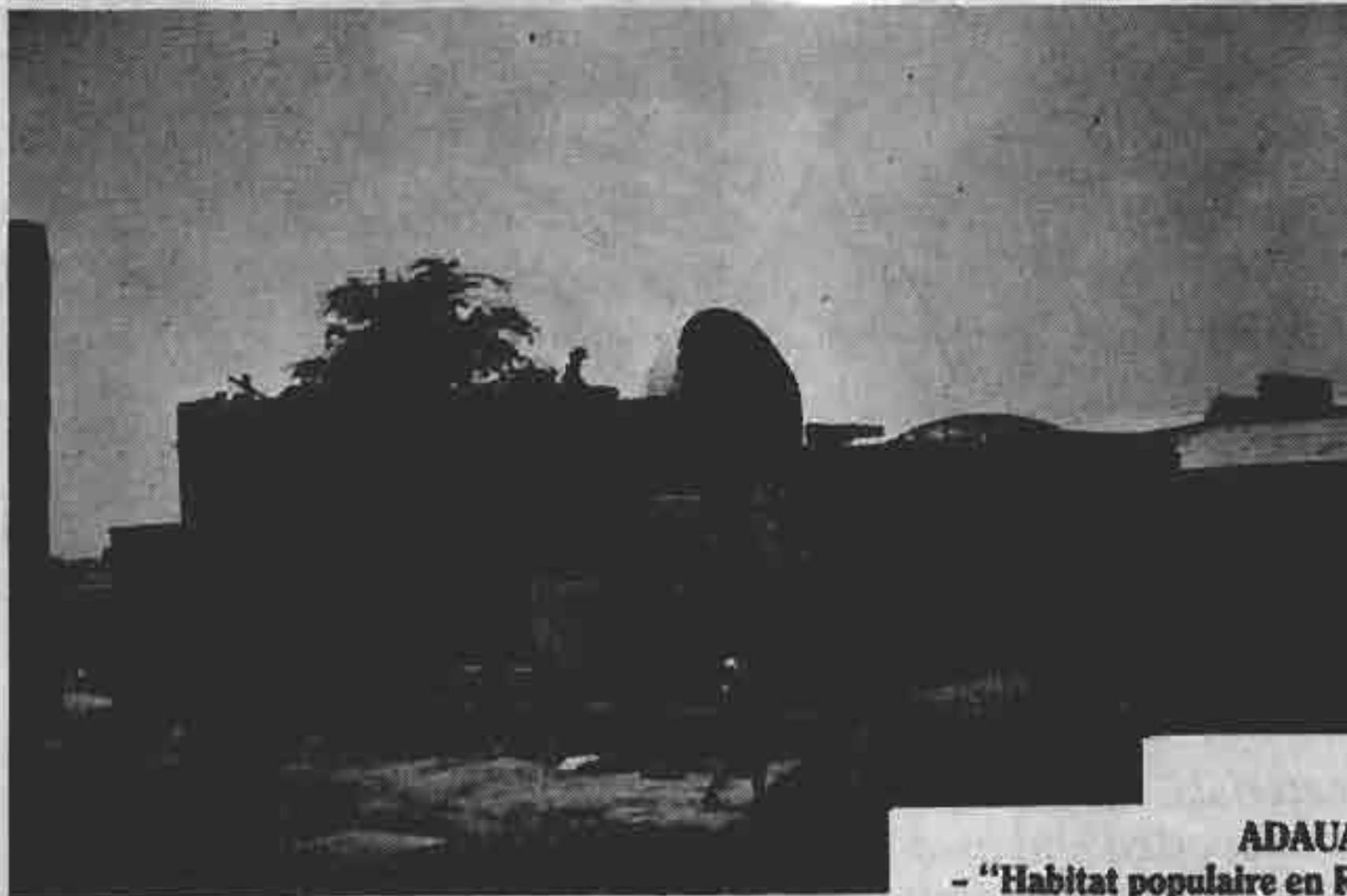

FIGURE 239: THE ROSSO SITE.



FIGURE 240:
THE ROSSO SITE

ADAUA PUBLICATIONS

- "Habitat populaire en République Islamique de Mauritanie", 1975. Out of stock.
- "Programme d'habitat populaire Rosso (RIM), chantier d'essais". The objectives, site progress, materials, brick production and training, application and site training. Rosso, 28th October 1977. French-English.
 - Dossier on presses. Currently being reprinted.
 - Dossier on mixers. Currently being reprinted.
- "Projet d'habitat populaire en Mauritanie". The urbanization of the Satara area, Rosso. French-English. Rosso, April 1978. Illustrations, photos, plans.
- Introduction: ADAUA's objectives and actions
- Chapter 1: analysis of the town of Rosso
- Chapter 2: proposal for the urbanization of the Satara area.

These works can be obtained from ADAUA's offices, route de Ferney, 1202 Geneva.

CHOOSING BETWEEN RAMMED EARTH, ADOBE AND COMPRESSED BRICKS

The selection of a given construction method depends on a number of considerations: technological, economic, climatic, and cultural. Establishing criteria for choice demands a good knowledge of all these factors and how they interrelate. Our intention here is not to set out a definitive chart of the decision-making process, but to set out the factors which will enable a better understanding of the problem. We are concerned here only with the three techniques of rammed earth, adobe and compressed bricks and take account only of the technological criteria: installation time, performance of the material obtained, and problems of implementation.

The soil: As far as the soil is concerned, if the soil around the house is adequate,

the problem is easily resolved. It will be recalled, however, that soil which includes gravel and stones will need to be sieved to make adobe or compressed bricks, whereas it can be used as it stands for rammed earth. If, for whatever reason, earth from the site is not available, transporting it will have to be considered. This problem will vary with different regional economic contexts. In France, transport - although expensive - is feasible. Indeed, all usual construction materials, including gravel and sand for cement, or brick clay, are transported, generally over distances of at least 10 to 30 km. In some cases, it can even be viable to take advantage of earth that has already been excavated (from road works, leveling, etc.) and which needs only to be transported.

The choice of building technique then

FIGURE 224: COMPRESSED EARTH BUILDING, CISSIN, OUAGADOUGOU, (UPPER VOLTA).



comes down to the mechanical performances required. The following table

shows the results of experiments carried out on various earth walls (ref. 26).

TYPE OF WALL	COMPRESSION (kg/cm ²)	Bending (a) (kg/cm ² of wall section)	PENETRATION (b) (kg)
Unstabilized earth			
ADOBE bonded with mortar (1)	6.84	0.03	450
RAMMED EARTH volume mass 2 kg/dm ³	6.16	0.028	450
Stabilized earth			
ADOBE Stabilized with a 5.6% bitumen emulsion mortar (1)	5.5	0.04	450
RAMMED EARTH stabilized with cement	45.73	0.05	450
COMPRESSED BRICKS stabilized with cement mortar (1)	57.05	0.05	450

- (1) Mortar: thin mixed mortar, made up of 200 kg of cement and 125 kg of hydraulic lime per m³ of sand
 (a) Bending: the wall was supported by two horizontal beams, at the top and bottom of the wall. The load was applied horizontally and was spread over two metal tubes spaced 1.2 m apart. In the case of the brick walls, the failure occurred in the joints.
 (b) Penetration: The load was applied horizontally to the end of a cylinder 2.5 cm in diameter, placed in the middle of a brick.

Walls : - brick : height 2.45 m; length 1.2 m; thickness 0.3 m
 rammed earth : height 2.45 m; length 2.4 m; thickness 0.35 m
 Adobe bricks (both stabilized and unstabilized) : - Dimensions 9 x 30 x 12 cm
 - Compressive strength (over a whole brick) : 35 to 44 kg/cm²
 Compressed bricks : - Dimensions 30 x 26 x 21 cm
 Compressive strength (over a whole brick) : 110 kg/cm²

The figures given in this table are chiefly of interest in comparison with each other; as absolute values they should be regarded as approximations.

The first consideration to strike one is that unstabilized walls in rammed earth and in adobe bricks have the same strength. Only the addition of cement increases their compressive and bending strength; bitumen even tends to weaken the wall. The question to be answered is therefore as follows: should the material be reinforced with a stabilizing agent (cement, lime, etc.)? According to official recommendations, the strength of all

these walls is adequate for a single-storey construction, with 40 cm thick walls. In addition, further tests were carried out on these same walls to measure their impermeability, that is to say their resistance to rain-water.

Cement-stabilized rammed earth	}	good
Bitumen-stabilized adobe bricks		
Stabilized compressed bricks	}	medicore
Adobe		
Rammed earth		

NOTE: In this series of experiments, the mortar appears to be far too weak for the strength of the bricks.

It therefore seems that only stabilization provides adequate protection against rain damage. But at the same time one cannot dismiss all the untreated earth houses of Brittany and the Dauphiné region of France, some of them centuries old.

There remains the question of the application time, which varies greatly according to the technique used. The following table compares the surface area of wall which one person can build in one day

	Rammed earth (d)	Adobe brick (e)	Compressed brick (f)
Surface area of wall in m ² (c) which one person can build in one day - in unstabilized earth	3	2.1	1.5
- in stabilized earth	2.5	2.0	1.2
Minimum desirable equipment	- shuttering - manual rammer	- sieve - mould - possibly mixer	- sieve - brick press
Minimum number of people on site	2 to 3	1	2
Degree of difficulty	Knowledge required	Medium	Quite Easy?!

(c) walls :	40 cm thick	moulding
(d) rammed earth :	erecting the shuttering filling it and tamping the earth removing the shuttering.	building the wall
(e) adobe bricks :	sieving mixing	(f) compressed bricks : sieving producing the bricks building the wall

(not counting the excavation of the earth):

The figures given have been established on the basis of the output of specialists and can vary from 1 to 5 between "amateur" workers and professional builders. Rammed earth thus appears to be the fastest process, but this must be weighed against the last criterion shown: degree of difficulty and knowledge required.

Rammed earth does in fact demand a good working knowledge of construction work: precise plans, good team coordination, precision in the setting-up of the shuttering, etc. With masonry construc-

tions, in contrast, the quality of brick production and of wall-building can be checked while they are in progress and "errors can be put right" at any moment; they also allow greater freedom in design.

There are of course innumerable other factors to take into account: the possibility of spreading the work over the whole year, the drying time needed, the number of people available, the complexity of the building to be put up, etc.

Whatever technology is selected, the important point is to find simple solutions and to achieve a durable, good quality building.

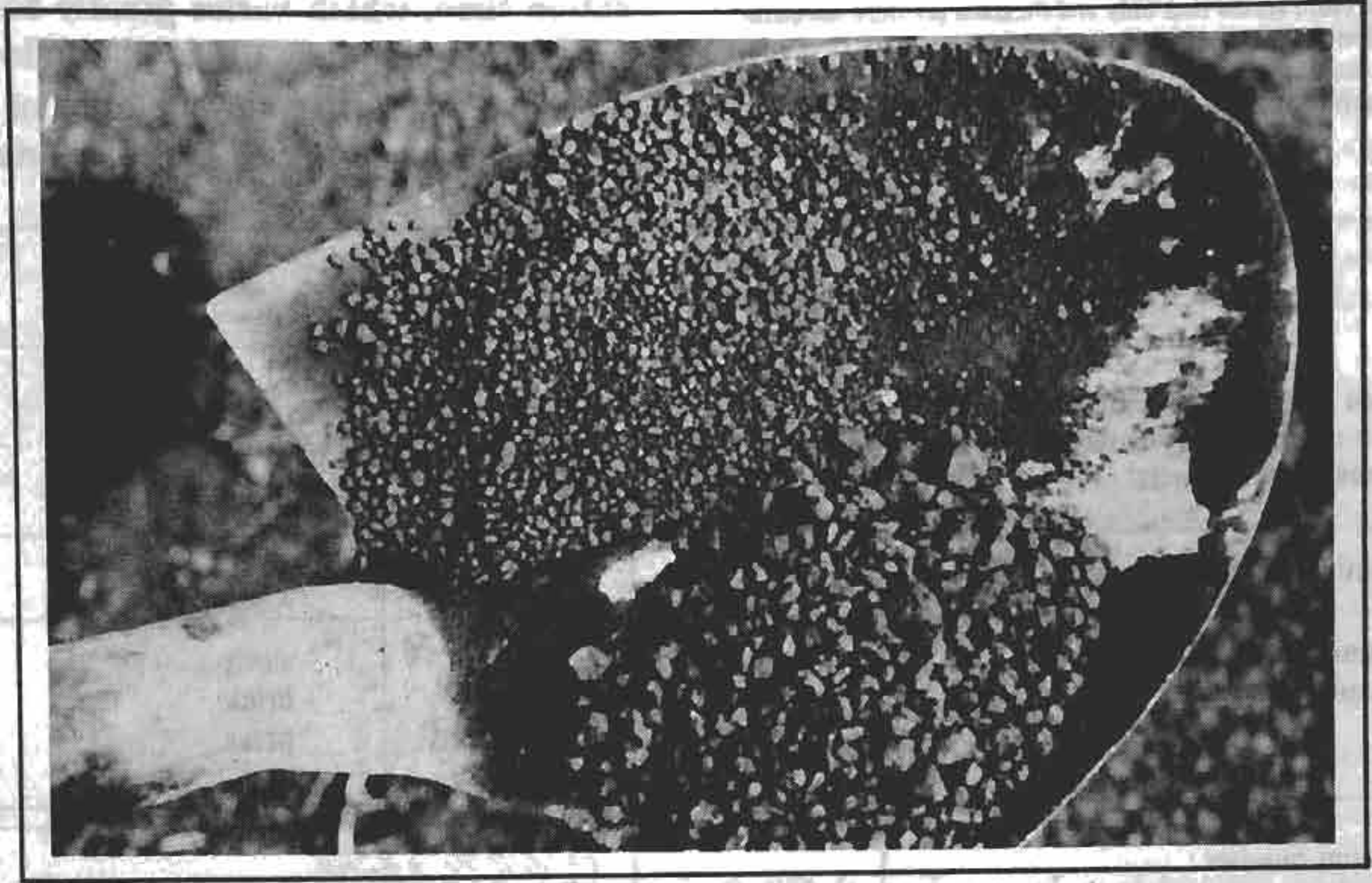

L.B.T.P. Abidjan

5. SOIL ANALYSIS

The builder's first concern will be to determine whether a given soil is suitable for some particular construction method.

This chapter therefore sets out the means at everyone's disposal to identify soil types. These consist either in laboratory soil analysis of samples previously collected, or in identification tests which are easy to carry out and which will give sufficient indication of the quality of soil it is hoped to use.

We consider first the composition of the soil, then the analysis methods normally used by laboratories, and finally the tests it is possible to carry out on site.

I. Soil composition

The upper layer of the earth's crust is mostly formed by the mechanical and chemical changes which occur in rocks as a result of weathering the effect of living organisms. Although its thickness varies greatly, it nearly always has approximately the same profile.

The topsoil or agronomic soil is rich in organic material; below it is the bedrock, which can be at various stages of change (fig. 241). When the upper layers are made up of loose

FIGURE 241:

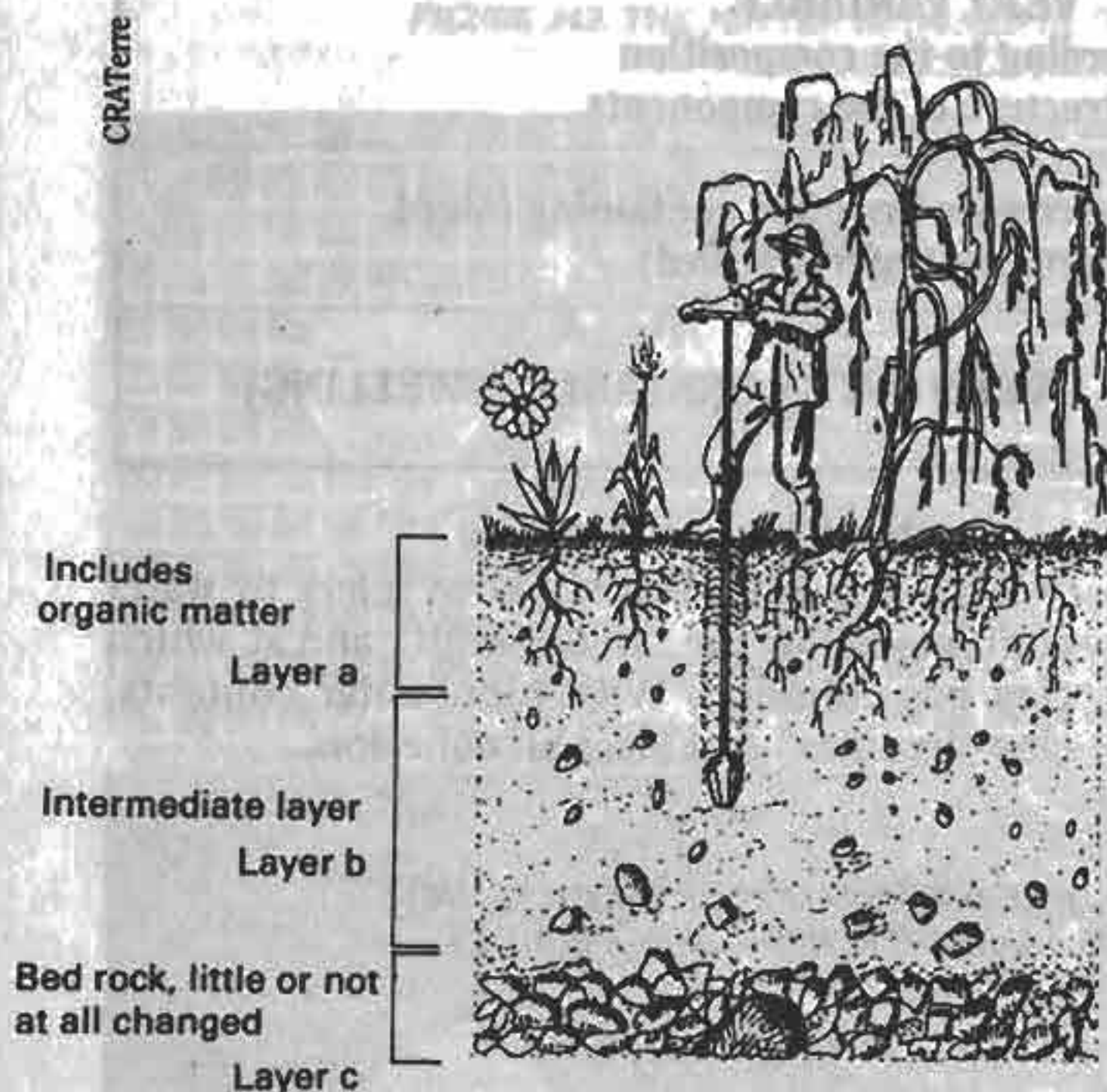

a) **Gravel** is made up of pieces of rock of varying hardness and the size of which ranges between approximately 5 and 100 mm. It is one of the stable constituents of a soil. Its mechanical properties undergo no perceptible modification when exposed to water.

b) **Sand** is made up of grains of minerals the size of which ranges approximately between 0.080 and 5 mm. Also a stable constituent of the soil, it lacks cohesion when dry, but has a high degree of internal frictional force, that is a very great mechanical ability when in contact to resist movement amongst the particles which make it up.

When slightly moist, however, it gives the appearance of cohesion as a result of the surface tension of the water occupying the spaces between particles.

c) **Silt** is made up of particles the size of which ranges between approximately 0.002 and 0.080 mm which have no cohesion when dry.

As its frictional force is generally lower than that of sand, when wet it displays good cohesion and it can, under varying degrees of humidity, undergo perceptible changes in volume, both swelling and shrinking.

Gravel, sand and to a lesser extent silt are thus characterized by their stability when exposed to water. Dry, they have no cohesion and can therefore not be used on their own as materials for making the constituent parts of a building.

d) **Clay**, which makes up the finest constituent part of soil (less than 2) has quite different characteristics to those of the other particle types. Most of the particles which make it up are microscopic specks of minerals, including clay minerals amongst which we will return to Kaolinites, Illites and Montmorillonites. Clay particles are coated with a film of absorbed water and their minute size means that their weight is very small in relation to their strength which is due to the surface tension which occurs in the film of absorbed water. Thus the volume strength is low compared with the surface strength.

Because the film of absorbed water holds very tightly to the surfaces it links the micro-particles of the soil together and it is this which gives clay its cohesion and which underlies its mechanical strength.

This can only be destroyed by very advanced

earth and contain little organic material they can be used for building with earth. In geotechnical terms they are known as soils and the study of their properties derives from soil mechanics.

Soils are made up of varying proportions of four types of material: various kinds of gravel, sand, silt and clay. Each of these behaves in a characteristic way so that, for example, when exposed to variations in humidity some change in volume and others do not.

The first three are stable and the remaining unstable. This notion of stability, by which we mean the ability to withstand variations in humidity and dryness without some change in the material's properties occurring, is of fundamental importance in a construction material.

desiccation. Clay lends soil its cohesion, acting as kind of binding agent between the coarser elements which constitute its skeleton.

However, unlike sand and gravel, clay is unstable, and will change when exposed to dif-

ferent degrees of humidity. It has a great affinity for water and when the water content increases the films of absorbed water become thicker and the overall volume of the clay increases visible ... Conversely, during shrinkage, cracks can appear

ORDER OF SIZE OF CLAY PARTICLES			
$1 \mu = 10^{-6}m$	KAOLINITES	ILLITES	MONTMORILLONITES
Length μ and breadth μ	0.1 to 2	0.01 to 0.5	0.05
Width μ	0.005 to 2	0.005 to 0.05	0.001 to 0.02
Specific surface	5 to 10m ² /g	80 m ² /g	80 to 800 m ² /g
REACTION TO VARIATIONS IN HUMIDITY	VERY VARIABLE according to the composition and structure of the components		
	Natural clays are composites often containing mixed of minerals (interstratified)		
	FAIRLY STABLE	VERY OFTEN UNSTABLE (SWELLING)	

in the clay mass and weaken it. With the next wet spell water will penetrate thanks to these cracks right to the heart of the material. This "swelling and shrinking" variation in volume of clay soils as a result of their water content is the

enemy that has to be defeated!

What has been stated above refers to water contents below the "liquid limit" and at which clay has cohesion. With high water contents, clay "liquifies" and loses all cohesion.

FIGURE 241a: TRIANGULAR REPRESENTATION OF TEXTURES, INRA ("INSTITUT NATIONAL DE RECHERCHES AGRONOMIQUES")

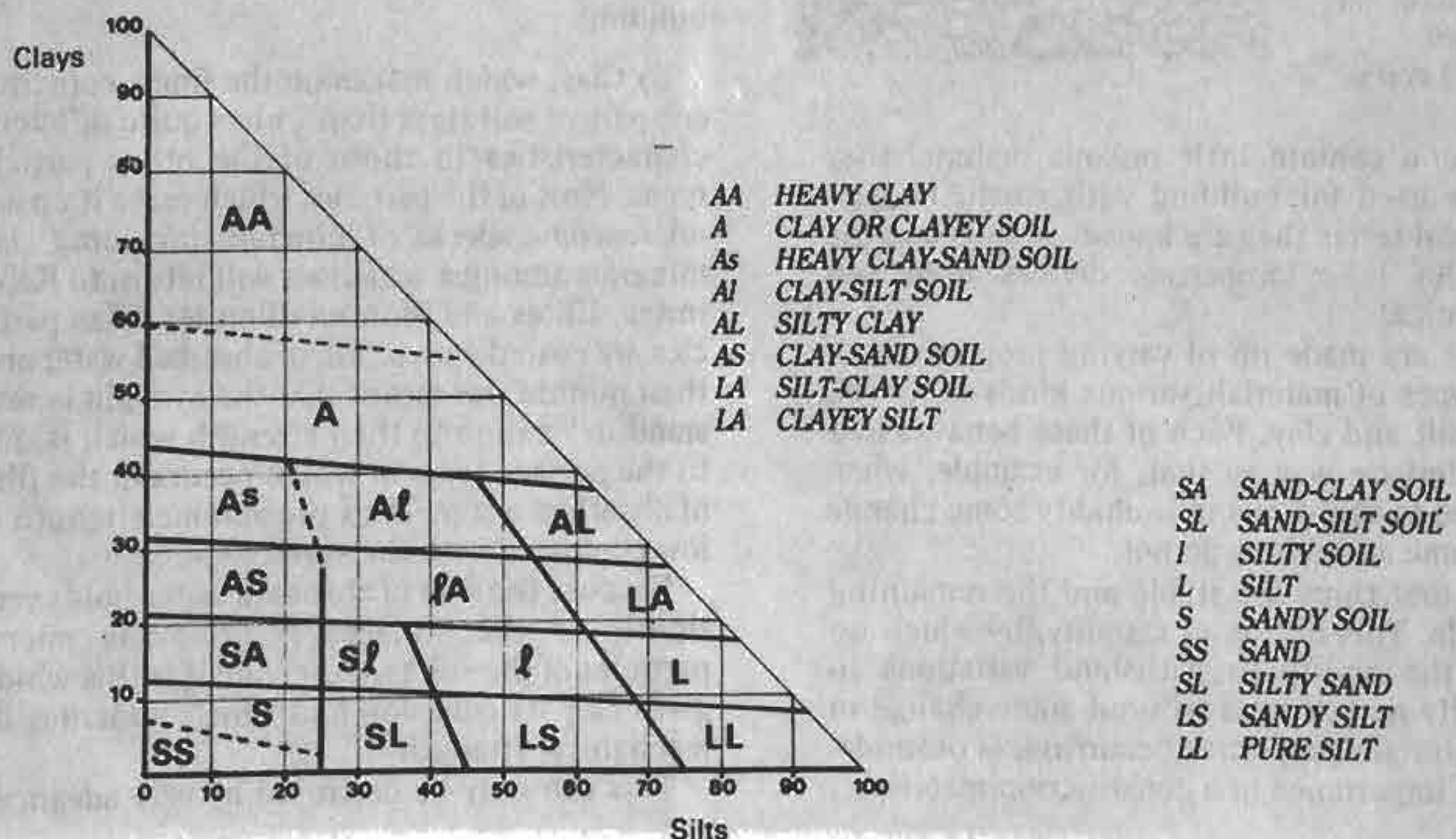

II. Soil identification

1. Collecting samples

This can be done using a spade to dig holes or trenches. Good earth is to be found in upper layers of loose earth low in organic matter. Topsoil, which is unsuitable because of the organic matter it contains, must therefore be removed. Samples of each soil found should be collected in sufficient quantities (fig 241).

Each sample is placed in a sealed bag, which must of course be labelled showing the location and the depth at which it was taken.

Soils can vary considerably from one point to

another over a small area and it is therefore necessary to take representative samples fairly close together, which is not always easy.

Once this is done, one can proceed to analyze the soils.

2. Laboratory testing

A - PARTICLE SIZE ANALYSIS

Particle size analysis allows one to determine the respective quantities of the various elements making up the soil (gravel, sand, silt and clay) (fig. 242).

FIGURE 242: THE MATTER RETAINED IN THE SIEVES SHOULD BE VERY CLEAN BEFORE BEING DRIED AND WEIGHED.

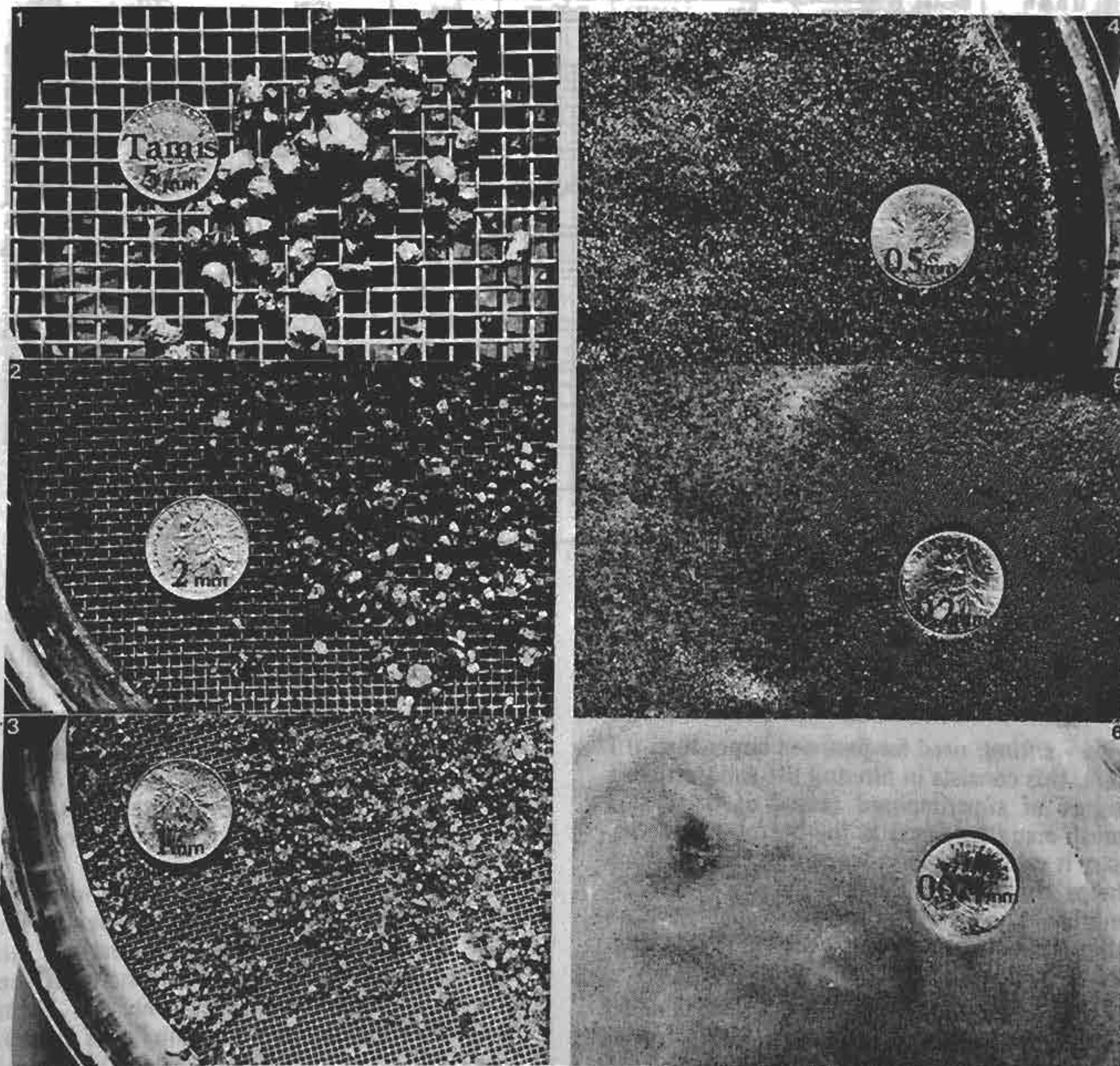

The results of the analysis can be presented graphically in the form of a "particle size distribution curve" drawn on a special diagramme (particle size diagramme), with the size of the particles plotted on the abscissa, and the cumulative percentage of sieved material on the ordinate.

This percentage expresses the proportion in weight compared to the weight of the sample when dry of the particles the size of which is

inferior to that plotted on the abscissa. Thus, the curve plotted on the diagramme shown in **Figure 243** shows that:

98% of particles passed through the 5 mm mesh
 83% 2 mm mesh
 72% 1 mm mesh
 62% 0.5 mm mesh
 52% 0.2 mm mesh
 45% 0.1 mm mesh

FIGURE 243:

PARTICLE SIZE ANALYSIS

Particle size curve

Example: Optimal curve for stabilized soil concrete

CLASSIFICATION

DECIMAL	Stones		Gravel		Coarse sand			Fine sand		Silt	Clay
U S B R	Stones	Gravel		Sand			Limons (Silt)		Clay		
		coarse	fine	coarse	medium	fine					

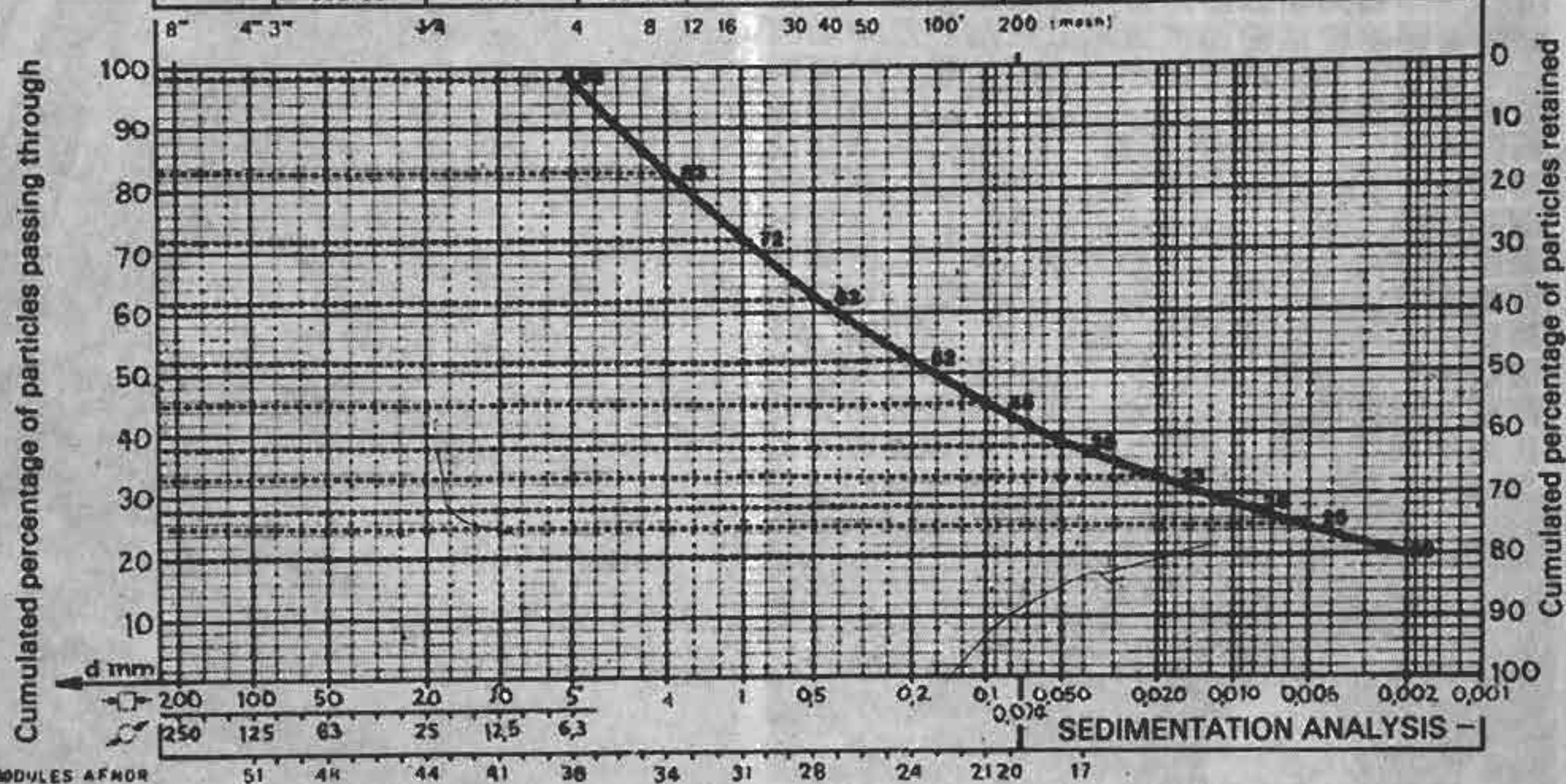

The size of the particles can be measured using two different techniques:

a - sifting: used for particles larger than 0.1 mm, this consists in filtering the soil through a series of superimposed sieves of decreasing mesh size (the finest at the bottom). If necessary it can be done under running water which helps the finer particles to pass through the meshes. The portions retained in each sieve are then collected and weighed after drying (fig. 244).

b - For the smallest particles, instead of using square mesh sieves, strainers with circular "meshes" can be used.

B - SEDIMENTATION ANALYSIS

After sieving, the tiny particles which have passed through the 0.1 mm mesh sieve are collected. As it would be extremely laborious, if not impossible, to try to sieve them through finer sieves, their size is measured thanks to sedimentation analysis.

This method exploits the difference in speed at which different soil particles suspended in water settle. The largest will settle first and the smallest last. The variation in density of the suspension is measured over time at a given height (density diminishes as the liquid clears). Knowing the various speeds at which different

FIGURE 244:

Particle size analysis

METHOD

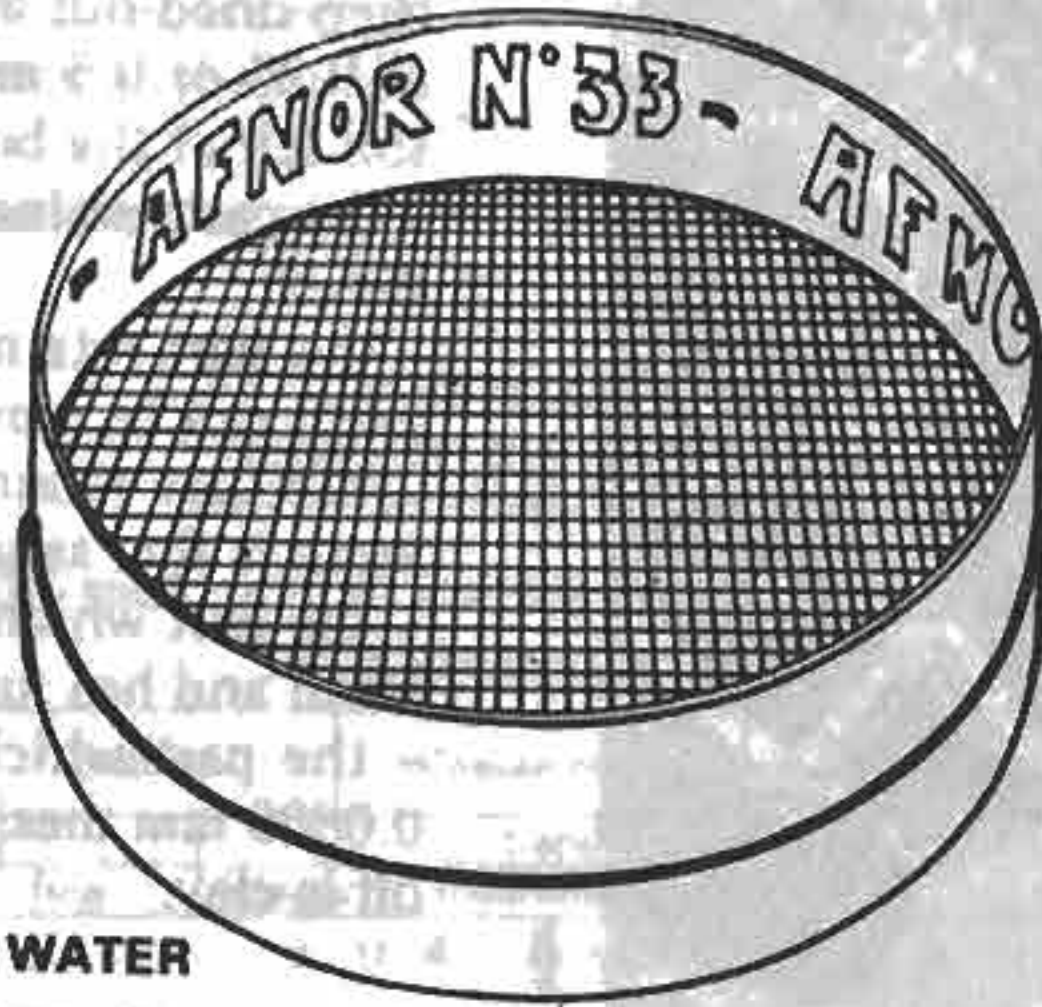

SIEVING UNDER RUNNING WATER

EARTH - WATER



RINSING



SIEVING

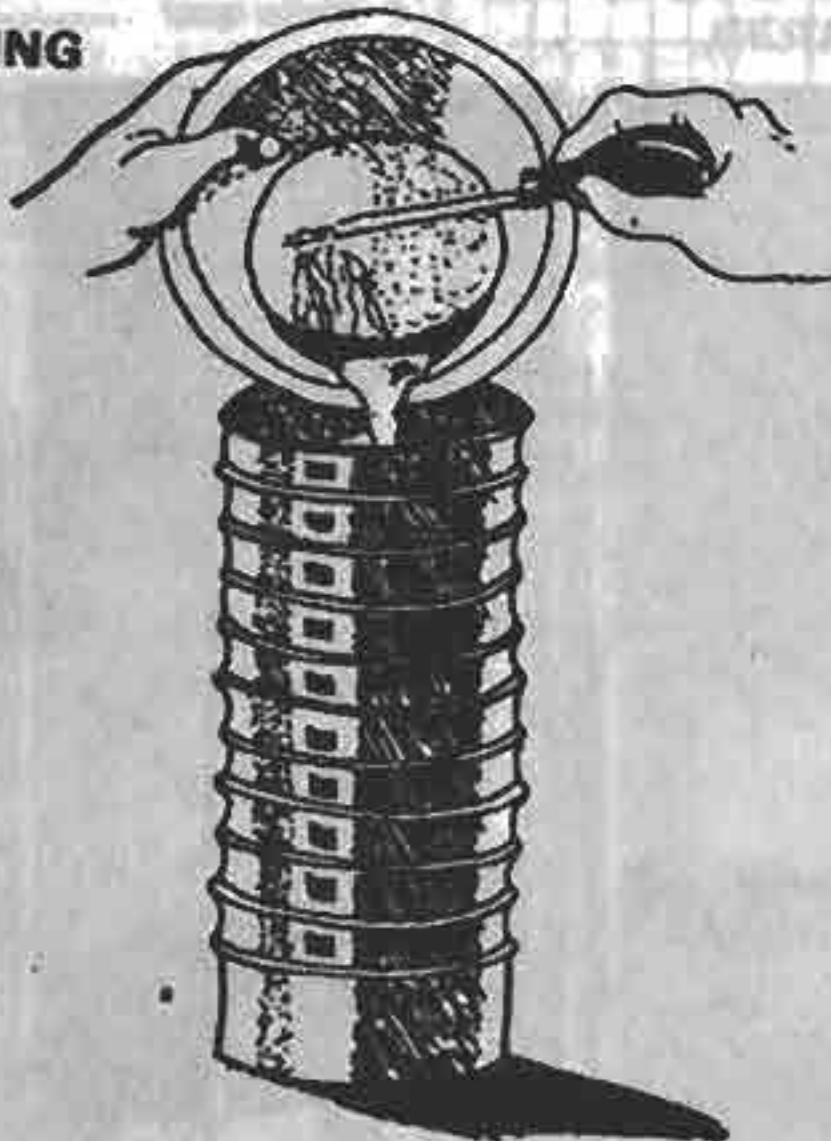

DRYING



WASHING



WEIGHING

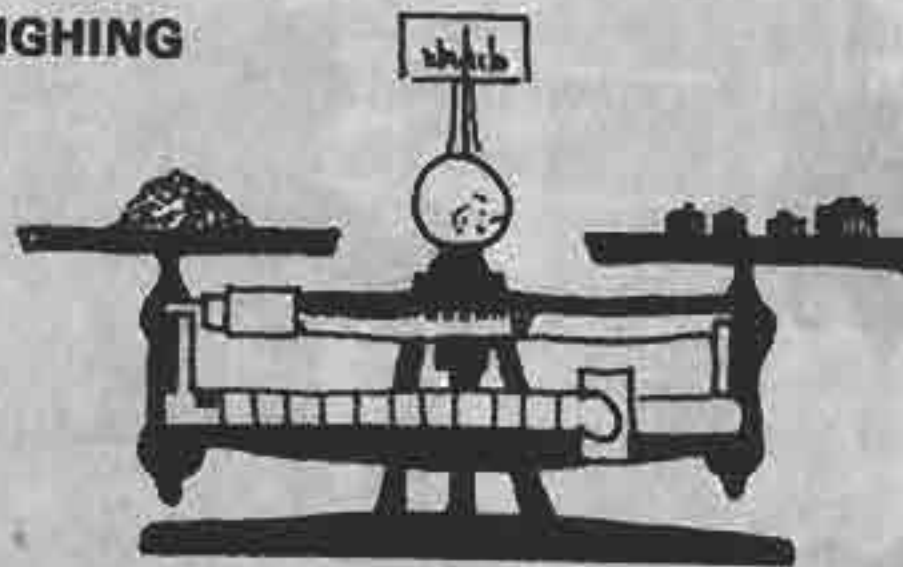

FIGURE 245: RESULTS OF PARTICLE SIZE ANALYSIS OF A LATERITIC SOIL.



CRA Terre

particle sizes settle, the proportions of different particle sizes can then be calculated (figs. 247-248).

A simplified variation of this process is the syphoning method.

Here water is added to all the soil which has passed through the 2mm or 5mm mesh. To ensure that the particles separate properly, a separating agent is used. For example: 20 ml of 3% Baumé sodium silicate, or 50 ml of a solution of gum arabic prepared with 45 g of powdered gum for one litre of water. This mixture is poured into a receptacle fitted with a magnetic plunger which is stirred for 1 minute. The mixture is then poured into a graduated measuring cylinder to a height of exactly 20 cm (this height being chosen because of the usual settling speeds of particles) and the whole is well shaken several times. The mixture is then left to settle for 20 minutes. A metallic disk is then carefully lowered into the cylinder until it touches the deposited material. This separates the deposited material from that in suspension. The material still in suspension is then

FIGURE 247: LABORATORY SEDIMENTATION TEST



CRA Terre

syphoned off with a flexible tube. This sample is then dried out and weighed; then with meshes of 0.25 or 0.5 mm and 0.074 or 0.080 mm the soil left at the bottom of the cylinder is sieved:

- the part retained by the 2 mm or 5 mm mesh is gravel;
- the part retained by the 0.25 mm or 0.5 mm mesh can be considered to be coarse sand;
- the part retained by the 0.074 or 0.080 mm mesh is fine sand;
- the part which passes through the 0.074 mm mesh and has formed a deposit is silt;
- the part which passes through the 0,074 or 0.0880 mm mesh ann which has been syphoned off is clay.

C - OPTIMUM PARTICLE SIZE DISTRIBUTION

Our brief review of the "mechanical role of soil constituents" at the beginning of this chapter has given an insight into the way in which gravel, sand silt and clay affect the structure of the earth. Elements such as gravel and sand provide the strength of the material, while clay ensures the cohesion of the whole; silt falls

FIGURE 248: EQUIPMENT FOR SEDIMENTATION TEST (1) BORE-SHAPED DENSIMETRE GRADUATED FROM 995 TO 1030, 2 1 LITRE CYLINDERS, 1 THERMOMETER, 1 PLUNGER, SEPERATING AGENT, 1 RECORD SHEET, 1 WATCH).

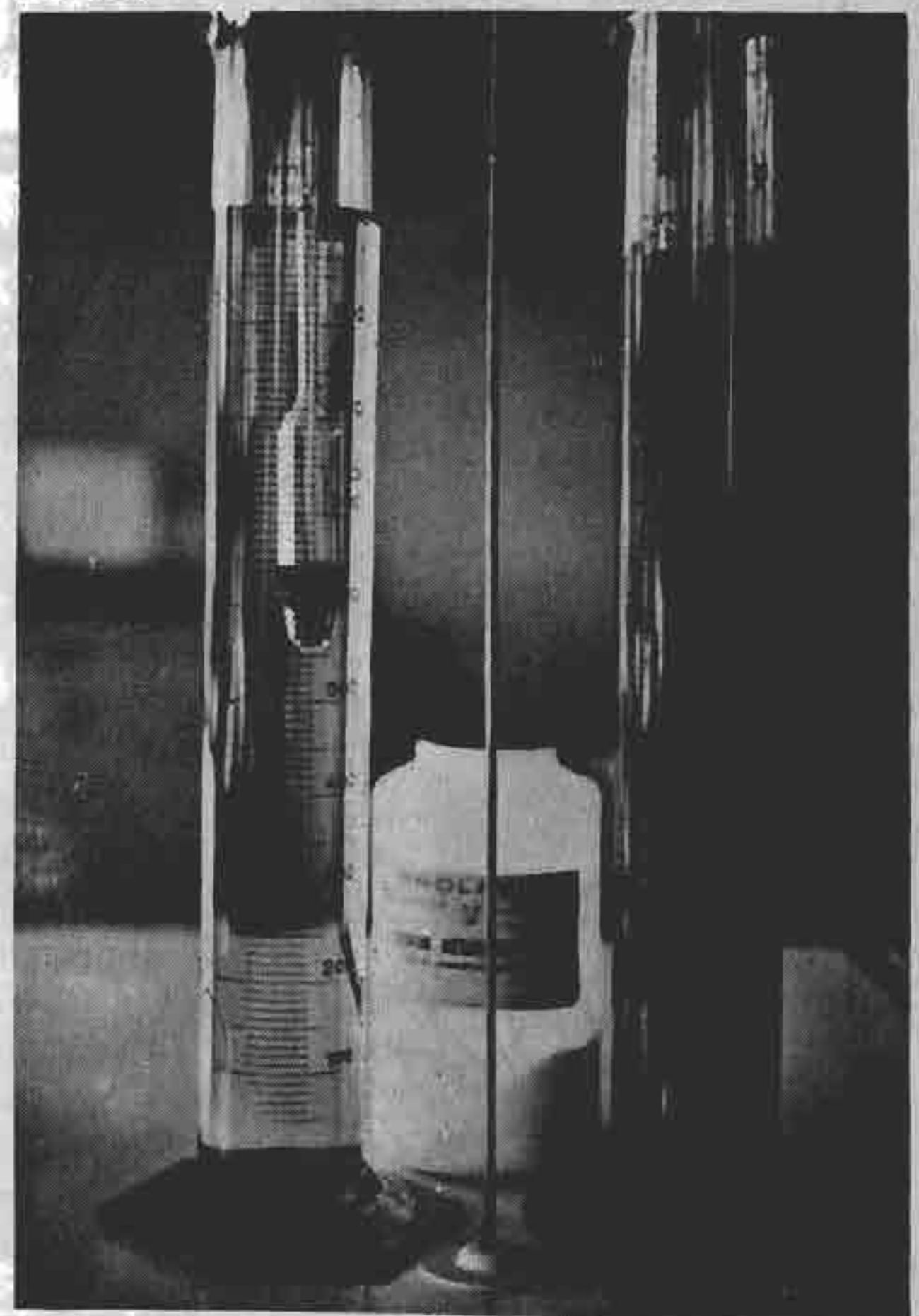

CRA Terre

somewhere between these, its role being less clearly defined.

In defining our optimum curve, our objective is to try to maximize the qualities of the different soil elements.

Combining the published particle size specifications for stabilized soil cement enables us to define the optimum size distribution which is graphically presented in the form of an "ideal curve", together with two additional curves showing the upper and lower limits of tolerance (fig. 249).

fications for stabilized soil cement enables us to define the optimum size distribution which is graphically presented in the form of an "ideal curve", together with two additional curves showing the upper and lower limits of tolerance (fig. 249).

FIGURE 249
PARTICLE SIZE ANALYSIS

The ideal curve for stabilized soil concrete and its limits of tolerance?

CLASSIFICATION

DECIMAL	Stones		Gravel		Coarse sand			Fine sand		Silt	Clay
U S B R	Stones	Gravel		Sand			Limons (Silt)		Clay		
		coarse	fine	coarse	medium	fine					

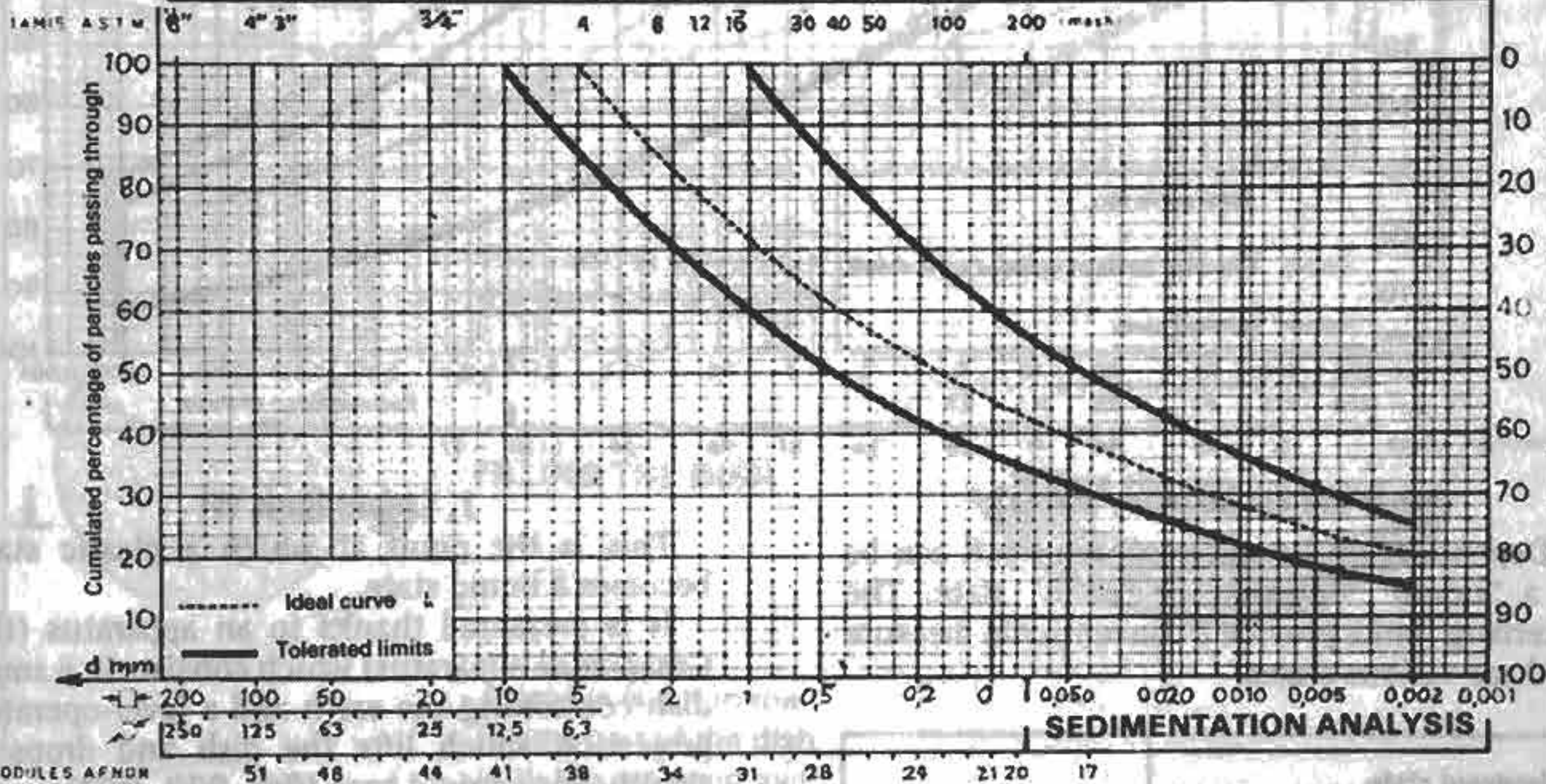

To meet the requirements of optimum particle distribution, soil intended for making SSC should fulfill the following conditions:

1. Its particle size distribution curve should be contained within the tolerated limits.
2. It should match the ideal curve as closely as possible.
3. It should be approximately parallel to the tolerated limits curves and to the ideal curve, especially where silts are concerned.

We also give tolerated limits for rammed earth and for compressed bricks (fig. 250). Whilst these limits guarantee a certain degree of security, it would not be true to say that outside of them it is not possible to build with earth. But there will be important problems to resolve.

D - ATTERBERG LIMITS

Particle soil analysis is concerned only with the size of the constituent parts of the soil which will to a large extent dictate its physico-

mechanical properties. It is not, however, the only relevant parameter. Thus, regardless of their size, various types of clay can display very different physical and mechanical properties according to the mineralogical or chemical composition of the particles.

Particle size analysis of clays must therefore be complemented by further tests.

E - CONSISTENCY STATES

Atterberg defined a series of standard tests which permit the analysis of variations in consistency of finely separated soils in relation to their water content.

As in the case of particle size analysis, statistical studies have been carried out with a view to defining the "ideal" Atterberg limits for soil concrete. Knowing the Atterberg limits also enables one to make a speedy assessment of the building potential of a soil.

PARTICLE SIZE ANALYSIS IQUE

TOLERATED LIMITS FOR RAMMED EARTH AND COMPRESSED BLOCKS

CLASSIFICATION

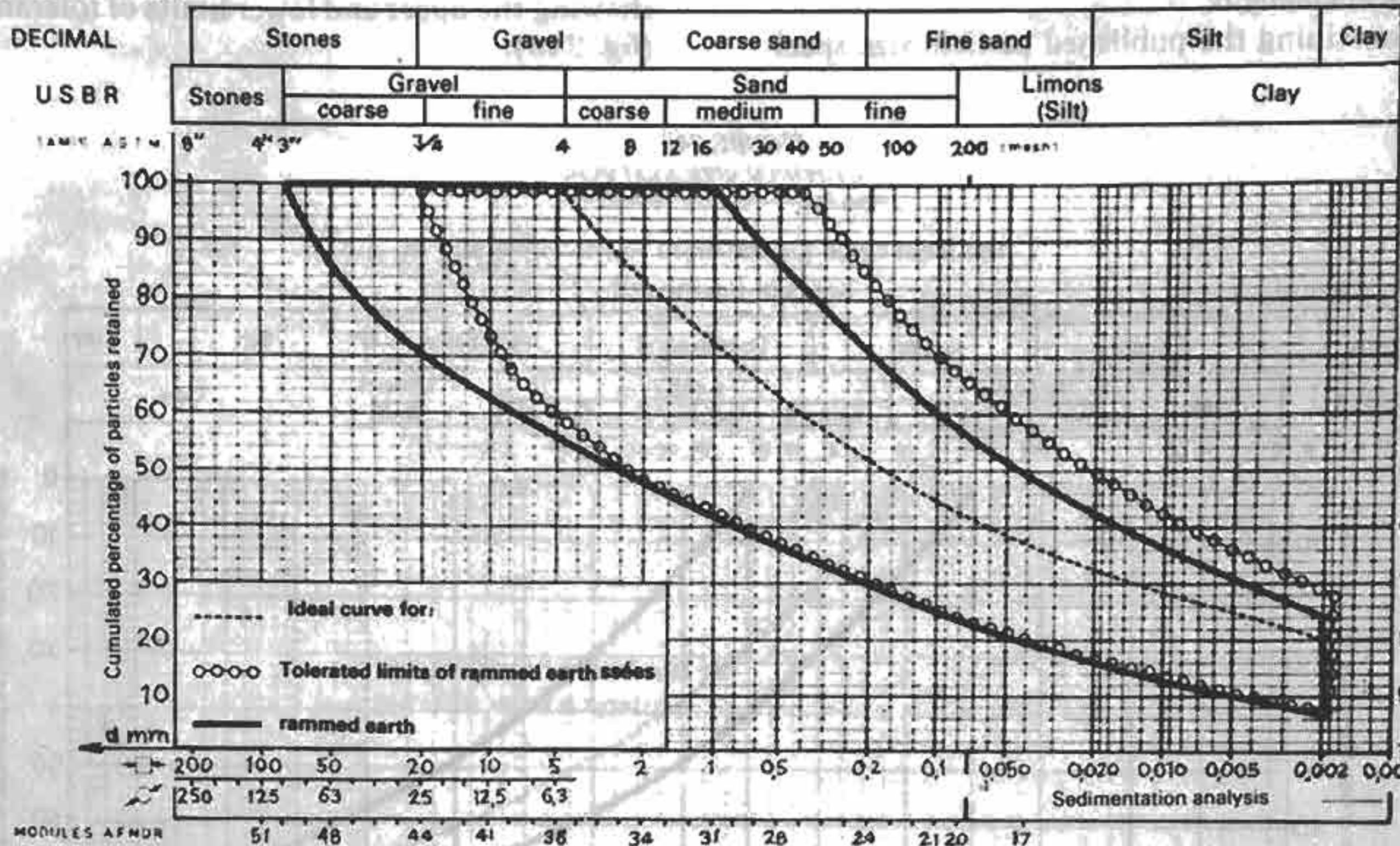

What are consistency states?

Depending on its water content, soil can be in a "liquid", "plastic" or "solid" state. The Atterberg limits provide a conventional measure of these various states:

Dispersed state	
Liquid state	
Plastic state	Liquidity limit W _l
Solid state, with shrinkage	Plastic limit W _p
Solid state, without shrinkage	Shrinkage limit W _r

The Atterberg limits are applied to the fine part of the soil known as soil "mortar" which includes the portion which passes through the 0.4 mm mesh, these being the only elements to be affected by water which modifies their consistency.

1. Liquid limit W_l

This is the point at which a plastic state becomes a liquid state.

It is measured thanks to an apparatus (the Casagrande apparatus) which consists in a small dish containing the earth and a lever-operated projection which lifts the dish and drops it sharply onto a rigid base (figs. 252, 253).

The earth is spread out in the dish with a spatula and then a special tool is used cut a groove in the earth down the middle of the dish. The dish is then subjected to a number of blows until the groove closes up in the middle by 1

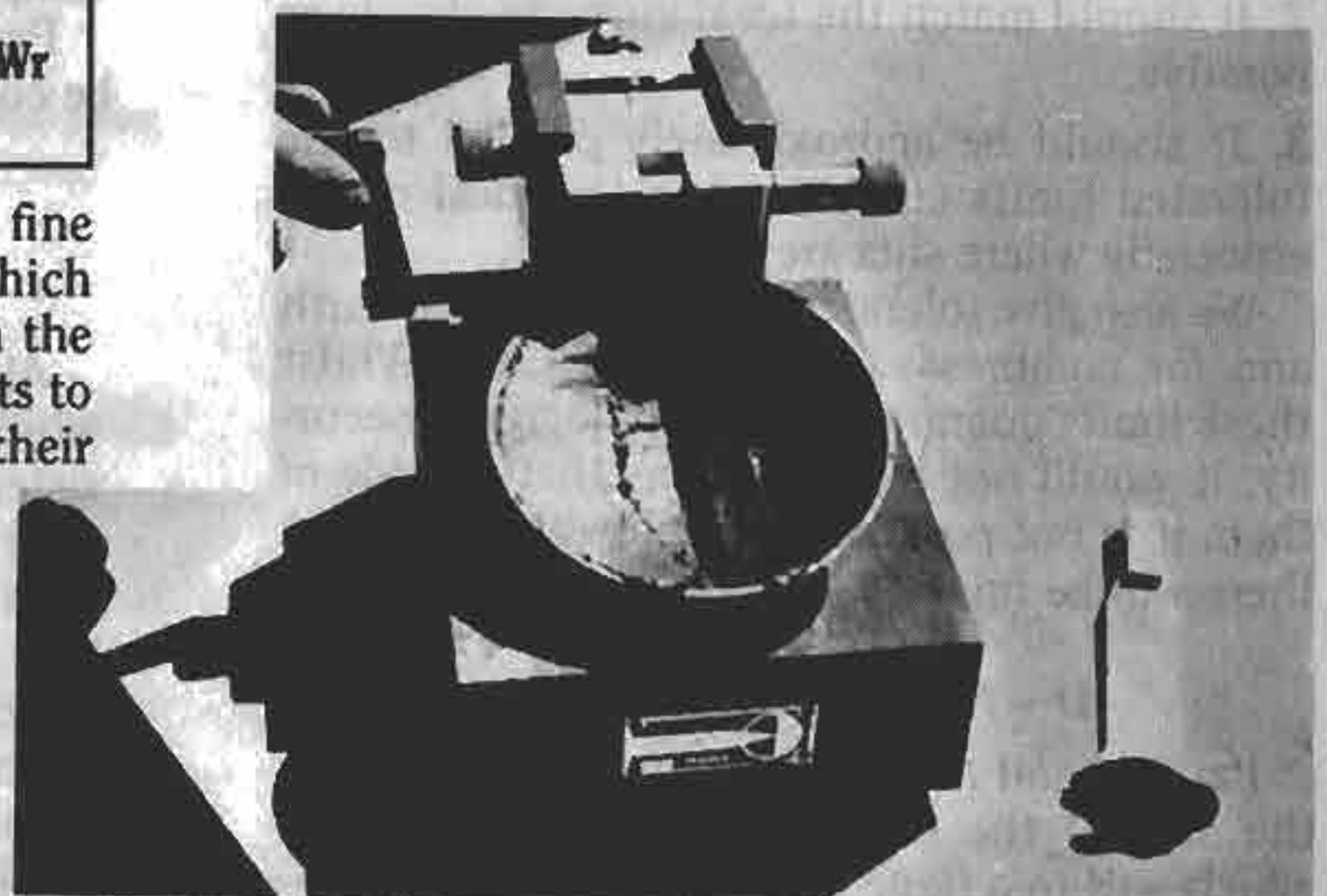
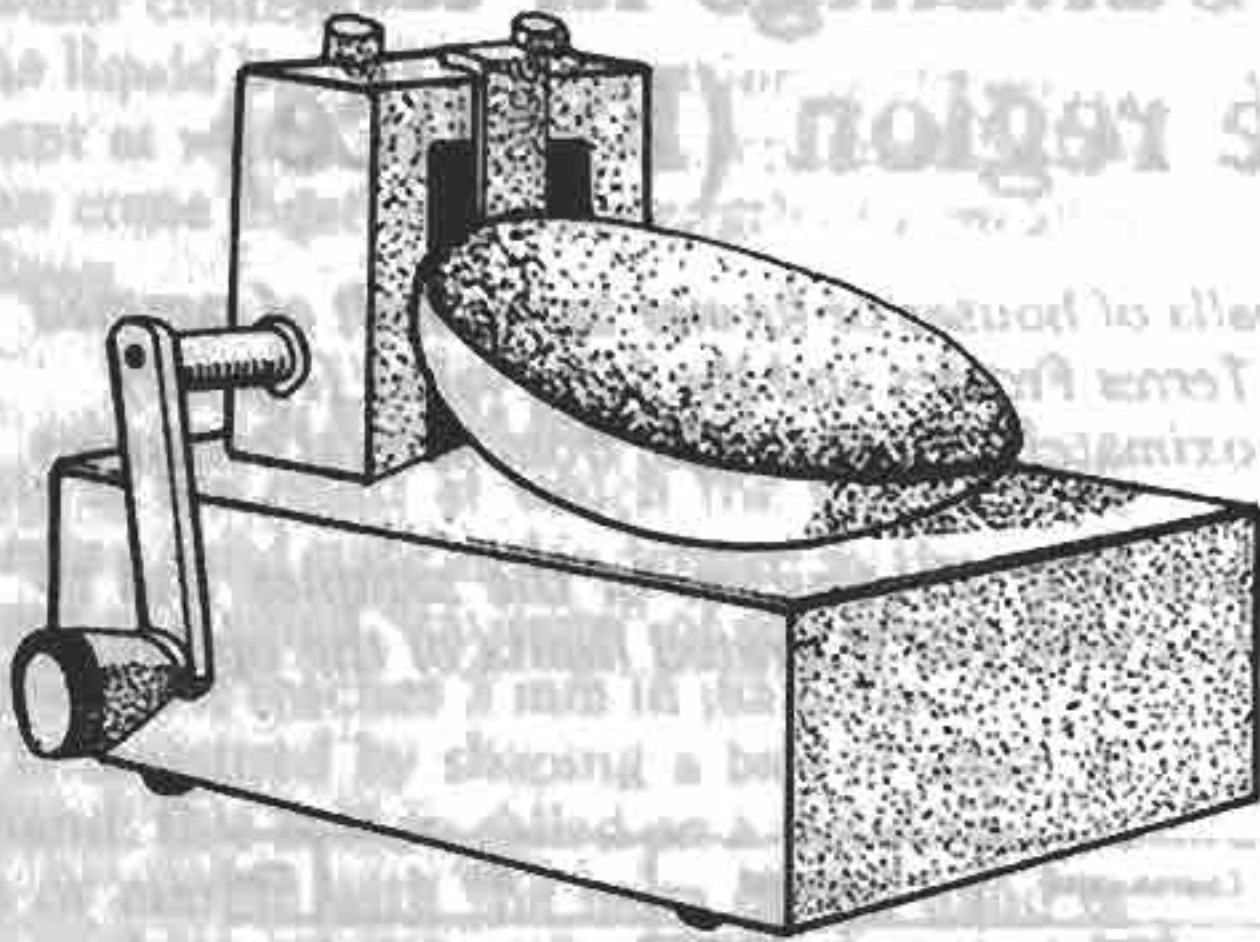

FIGURE 253: "CASAGRANDE" APPARATUS FOR DETERMINING THE ATTERBERG LIMITS

"CASAGRANDE" APPARATUS

LIQUID LIMIT METHOD



special grooving tool



The earth is spread out in the dish with a spatula

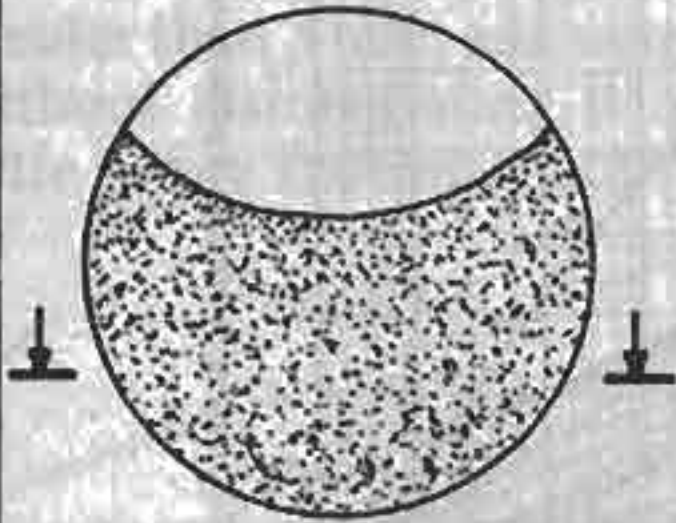

FILLING THE DISH



Before the groove is cut

A groove is cut in the lowest part of the dish with the grooving tool

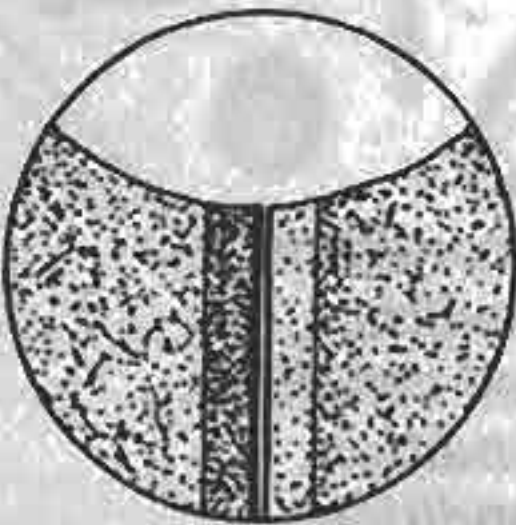

CUTTING THE GROOVE



After cutting the groove

The dish is then knocked by operating the lever

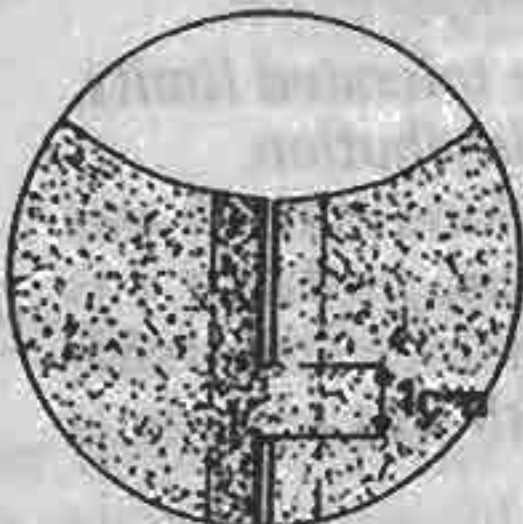

THE GROOVE CLOSES UP AGAIN



After knocking the dish

The liquid limit is attained when the groove closes over 1 cm after 25 blows

Particle size analysis of rammed earth buildings in the Lower Dauphiné region (France)

About 20 samples were taken from the walls of houses or former barns built of rammed earth in the regions of Chambaran, Bièvre, Terres Froides and the Isère valley (France).

Some of these buildings dated from approximately 50 years ago, from several centuries before.

We then proceeded to analyze the particle size distribution of the samples and to compare their particle size distribution curves with the tolerated limits of the optimum distribution (fig. 251).

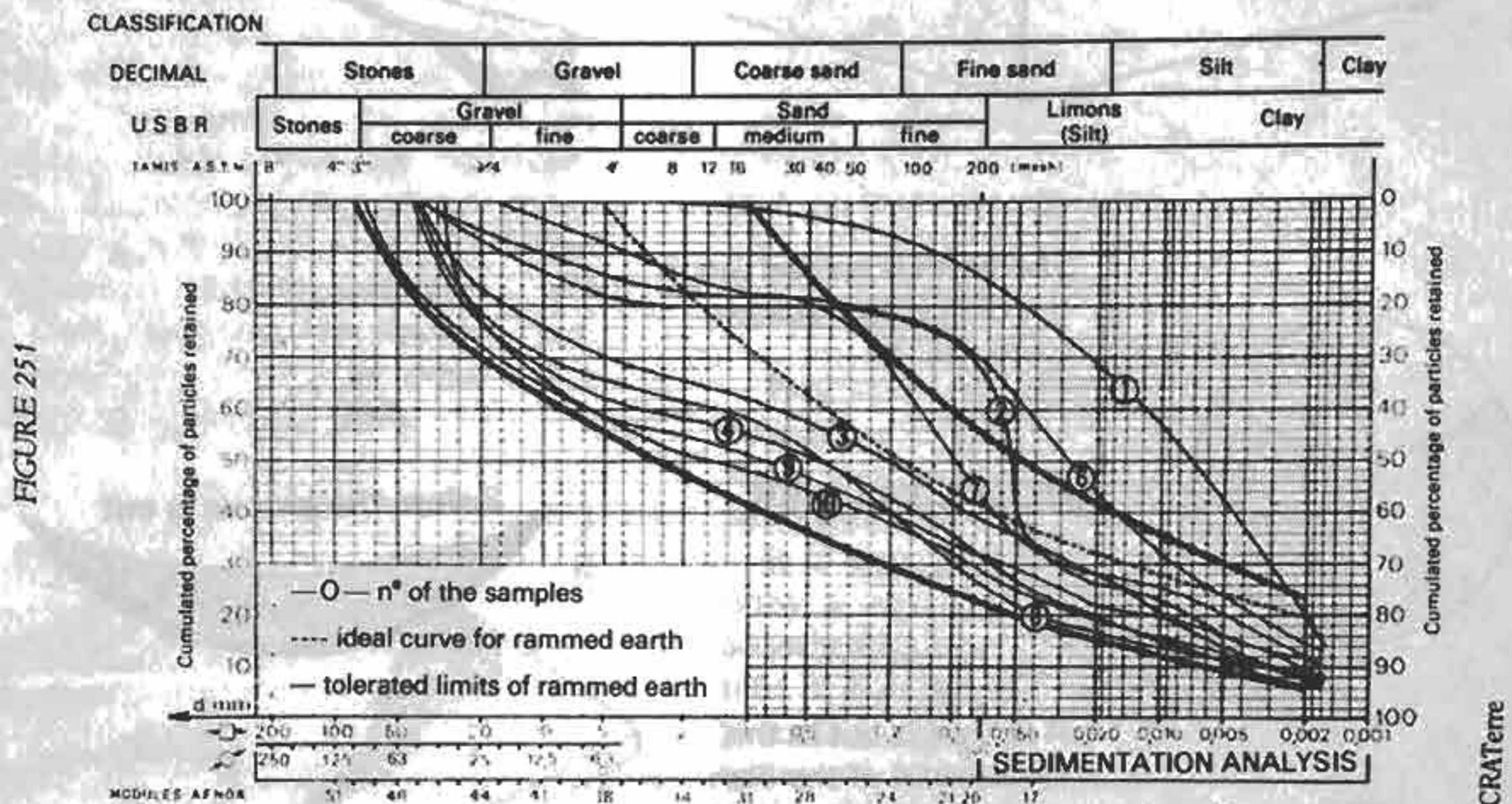

List and source of samples

- | | | |
|---|-------|----------------------|
| 1 - On the banks of the Isère near Tullins | House | in ruins. |
| 2 - Chambaran - St.Paul d'Iseaux | Barn | in poor condition. |
| 3 - Chambaran - St.Paul d'Izeaux (L'Abbaye) | House | good condition. |
| 4 - Bièvre plain | Barn | very good condition. |
| 6 - Terres Froides - Eydoches | House | good condition. |
| 7 - Terres Froides - Batie Division | House | good condition. |
| 8 - Terres Froides - St-Geoir en Valdaine | Barn | very good condition. |
| 9 - Bièvre plain - Le Grand Temps | House | good condition. |
| 10 - Bièvre plain - Le Grand Temps | House | in ruins. |

With the exception of samples 1 and 2, all the curves were within the tolerated limits, which is in line with the conclusions of our study of optimum particle distribution.

Sample no. 1 was taken from a ruined house built with a silty soil. This kind of earth was not normally used for building, as in this area, on the banks of the Isère, building was normally done in rough-cast rounded stones. The choice made in this instance was probably attributable to the individual builder who may have been familiar with this technique and applied it inappropriately.

The poor quality of sample no. 2 is probably due to a poor choice of excavation site as, normally, in this area, soil has a better particle distribution profile. The building showed signs of erosion.

cm. A little water is added and the test is repeated; the same result will be achieved with a smaller number of blows. The changing number of blows is recorded on a curve together with the water content.

The liquid limit is an expression of the water content at which the 2 halves separated by the groove come together over a length of 1 cm after 25 blows.

2. Plastic limit W_p

This is the point at which the plastic state becomes a solid state and is defined by the water content of a small "sausage" of soil which falls apart when it reaches 3 mm in diameter.

It is measured by shaping a ball of earth in the hand; this is then rolled on a flat surface of glass or marble with the palm of the hand or with a sheet of "plexiglass". The earth has reached its plastic limit when the "sausage" obtained with a diameter of 3 mm disintegrates into small pieces of 1 or 2 cm in length. If the sausage disintegrates when its diameter is still greater than 3 mm, add water. If it reaches 3 mm without disintegrating it must be dried out a little before starting again (fig. 254).

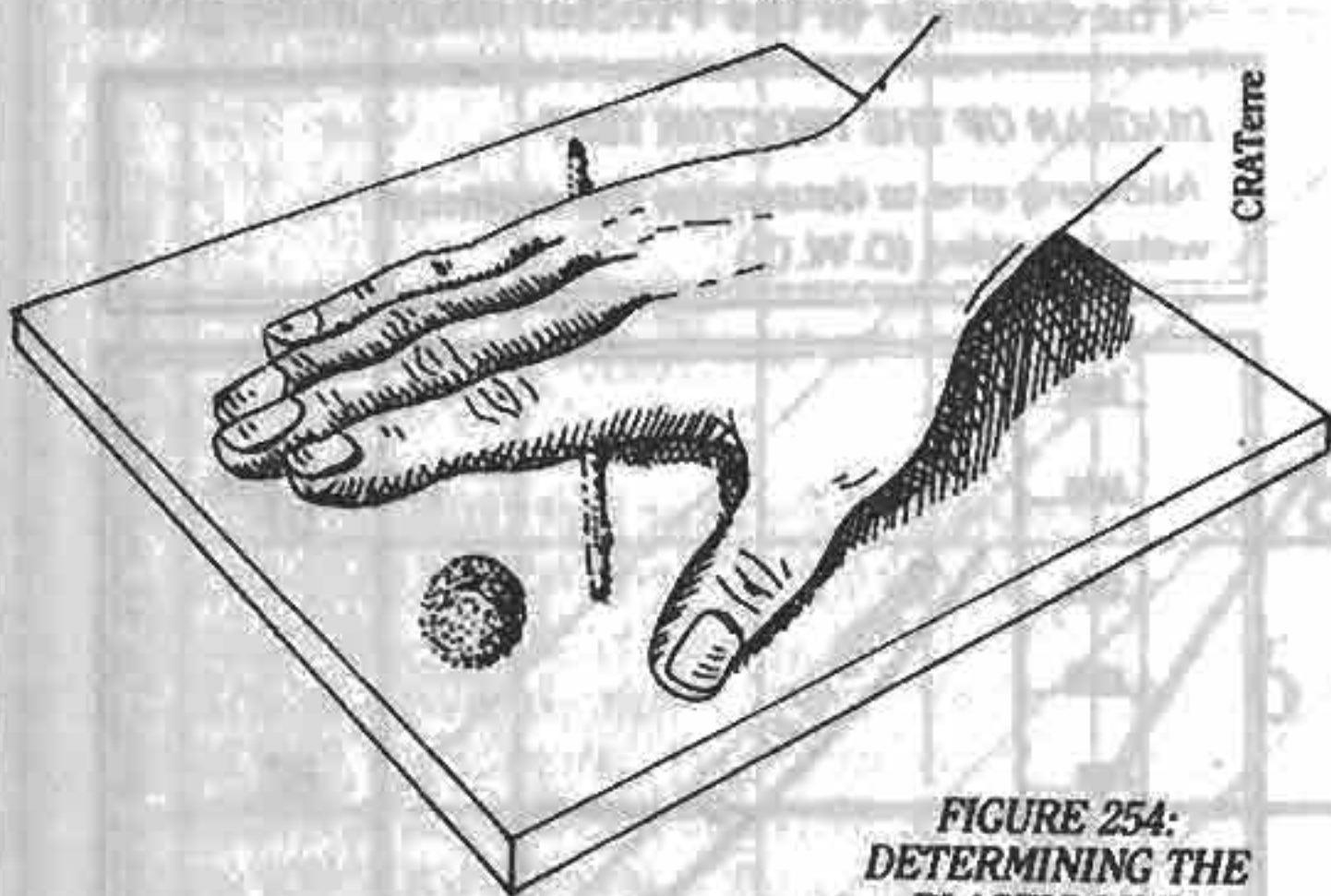
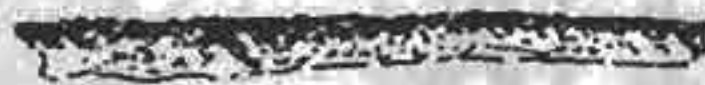
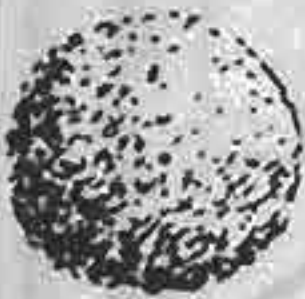

FIGURE 254:
DETERMINING THE
PLASTIC LIMIT



After baking dry, the equivalent water content is calculated (weight of water divided by dry weight).

3. Plasticity index I_p

Once the plastic limit and the liquid limit have been determined, the plasticity index can be calculated thus: $I_p = w_l - w_p$

- low plasticity : I_p from 5 to 10
- medium plasticity : I_p from 10 to 20
- high plasticity : I_p over 20

For the purposes of illustration, here are the I_p and w_l for various soil types:

- sand: I_p from 0 to 10 w_l from 0 to 30
- silt: I_p from 5 to 25 w_l from 20 to 50
- clay: I_p over 20 w_l over 40

4. Shrinkage limit W_r

The shrinkage limit corresponds to the water content below which the volume remains constant. To determine this, a soil sample with a water content close to w_l is dried out while its changes in volume and mass are measured. When the water content decreases through evaporation, the volume decreases more or less linearly. Once the particles are touching, the volume ceases to decrease while the water content continues to fall.

5. Water Absorption limit W_a

Besides the three Atterberg limits, the water absorption limit, which corresponds to the water content at which water will no longer penetrate the material, is also relevant.

It is measured by letting a drop of water fall onto a very smooth earth. If the water is absorbed in less than 30 seconds, the water content of the sample is increased equally and the process is repeated, and so on, until the drop of water no longer penetrates a horizontal side within 30 seconds. The drop then forms a shiny patch.

Logically, the absorption limit should be higher than the shrinkage limit in which case the material has a tendency to absorb moisture and swell. It can sometimes be lower than the shrinkage limit, which means that the material will certainly not swell. The latter case is of course preferable.

6. Activity coefficient

The activity coefficient gives an idea of the likely swelling and shrinkage of a soil. It represents the relationship between I_p and the percentage of particles inferior to $2 \mu m$ (clay).

$$C_a = \frac{I_p}{\% \text{ clay } (\phi < 2 \mu m)}$$

Soils can be categorized as follows depending on their degree of activity:

- C_a less than 0.75 Inactive (I)
- from 0.75 to 1.25 . Medium activity (MA)
- from 1.25 to 2 Active (A)
- C_a over 2 Very active (VA)

From the point of view of mechanical performance, it can be said that an inactive soil might not require stabilization, and that a soil with medium activity will certainly need it.

If one combines the results of optimum particle size distribution with the clay percentages which fall between 15 and 25% the following table can be laid out:

Plastic range	Activity	Stabilizer (quantity)
1-2-3	inactive	very little or none
4-5-6-7	medium activity	little to average
8-9-10	active	considerable
11-12-13		

Figure 256 shows the variation in Atterberg limits in a soil in which the proportions of sand and clay were made to vary.

FIGURE 256

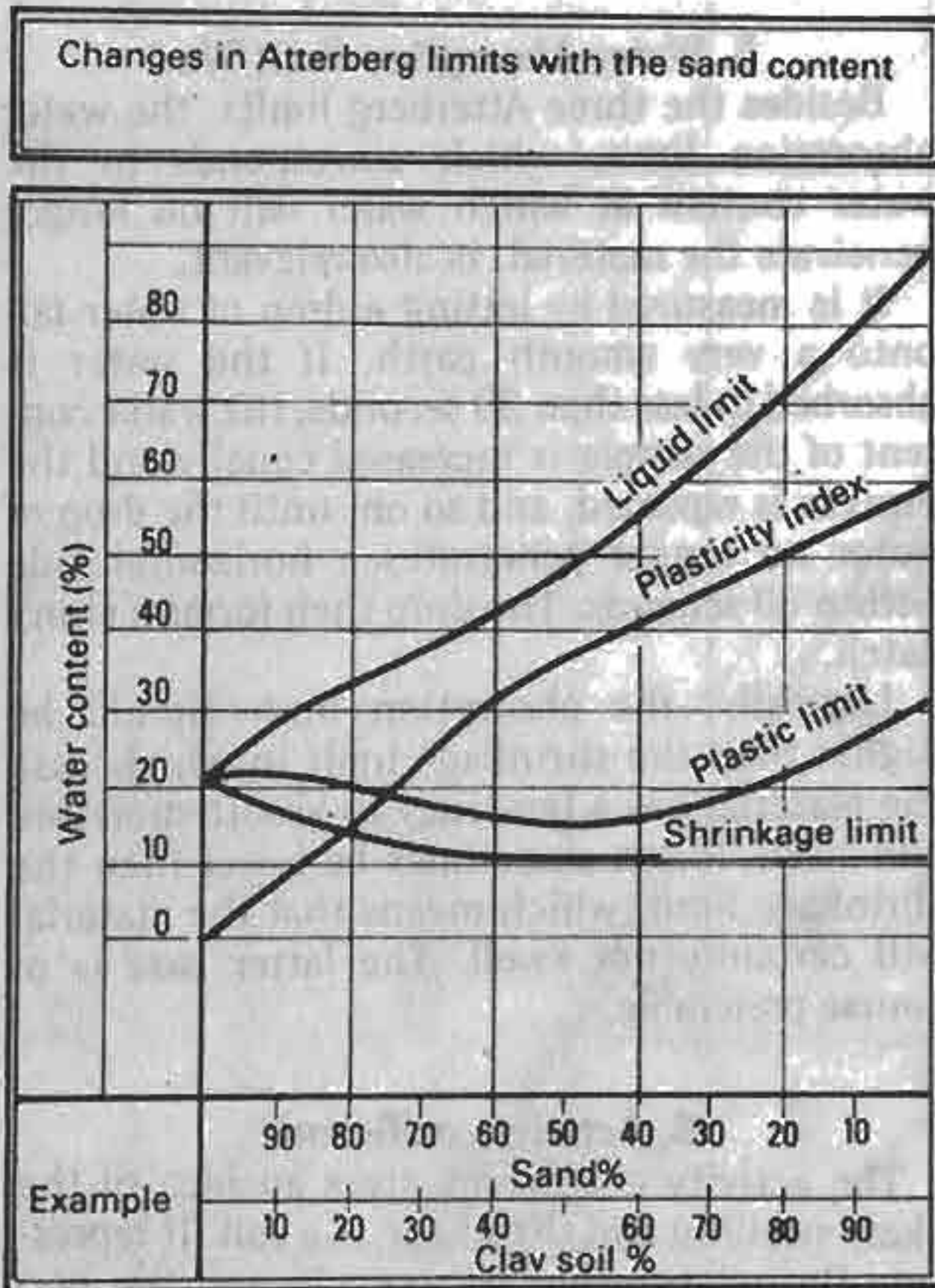

CRATerre

Studying the specifications relating to the Atterberg limits suggested by various authors enables us to measure the frequency with which the same selections occur and in this way to obtain an overview and a classification in order of preference of the Atterberg limits (fig 255).

176 The table set out below gives a recapitulation

of the specifications relating to the Atterberg limits:

	Range of tolerance	Preferred range
Ip	from 7 to 29	from 7 to 18
Wl	from 25 to 50	from 30 to 35
Wp	from 10 to 25	from 12 to 22
Wr	from 8 to 18	Wr < O.W.C.
Wa	Wa < Wr Wa < Wp	

F. PROCTOR TEST

Compaction is the first way to improve the strength of a soil. To be effective it should be carried out on material with a water content which ensures the lubrication of the soil particles enabling them to rearrange themselves in such a way as to take up as little space as possible. The objective of the Proctor test is to determine this water content, which is known as the "optimum water content" (O.W.C.) of compaction.

a) - Underlying principles of the method

The example of the Proctor diagramme given

DIAGRAM OF THE PROCTOR TEST

Allowing one to determine the optimum water content (O.W.C.)

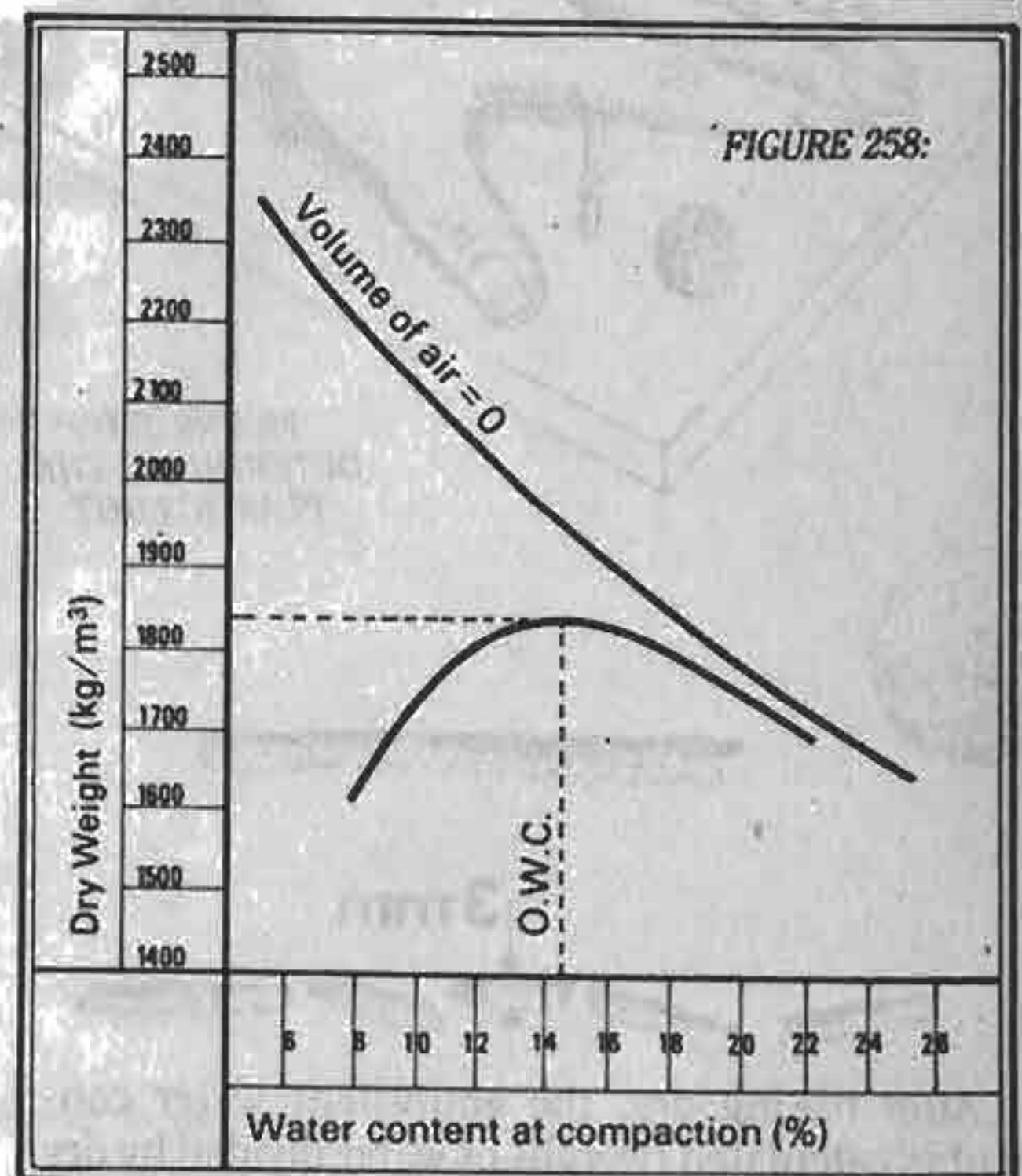

CRATerre

(fig. 258) shows that the O.W.C. is 14.5%. This water content corresponds to the greatest weight possible given the force of compaction applied.

The underlying principle of the test is as fol-

FIGURE 255

Classification in order of preference of Atterberg limits (1, 2...)

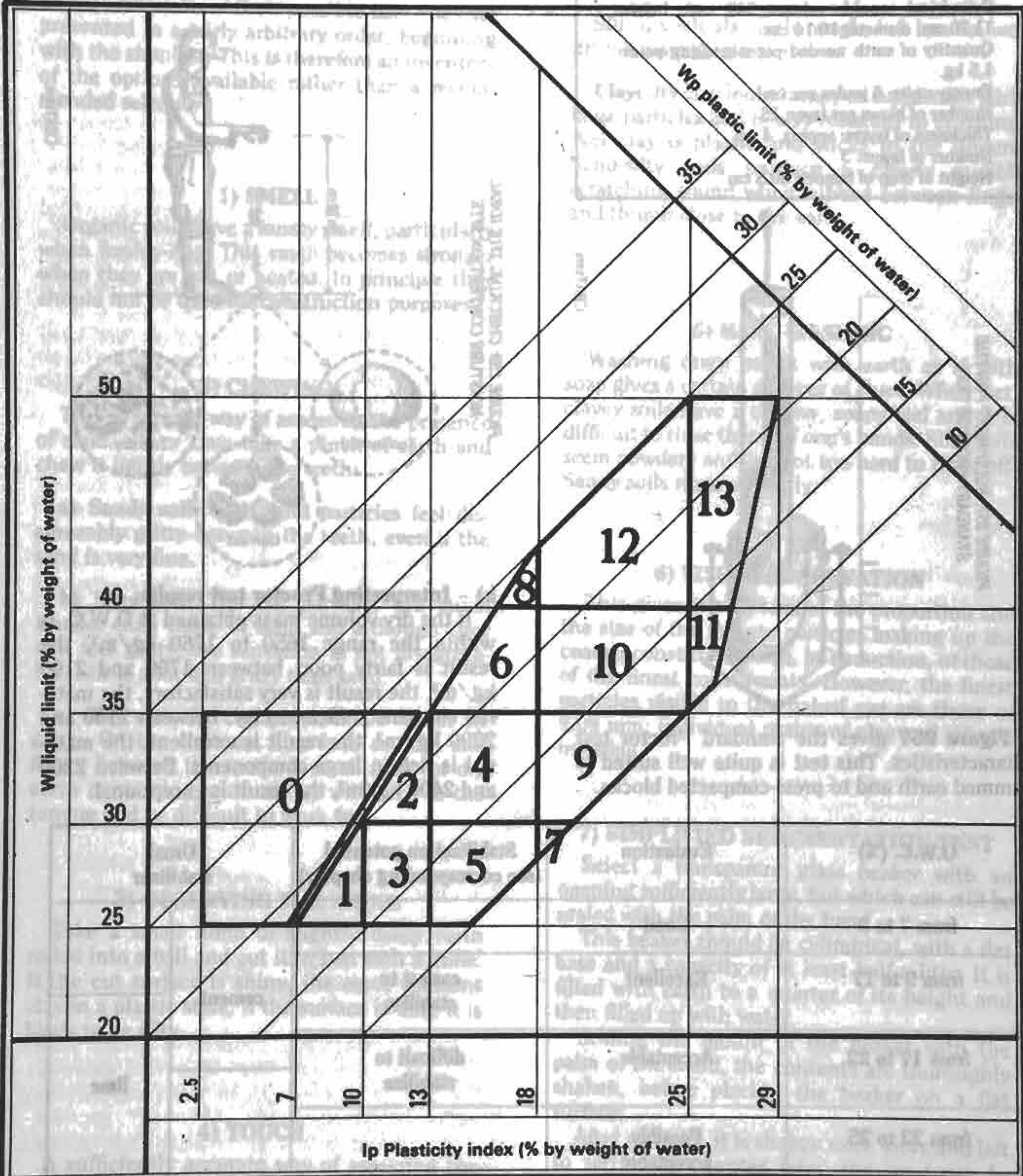

lows: a sample of earth of known water content is placed in a cylindrical mould and tamped following the method of operation. The compacted sample is then weighed and its water content checked. The dry volume is calculated and recorded on the Proctor diagram with the corresponding water content.

STANDARD PROCTOR TEST

Tamper: 2,496 kg mass. Diameter 5.08 cm.
 Cylindrical mould: volume 949 cm³; height 11.70 cm; diameter 10.16 cm.
 Quantity of earth needed per measuring point: 1.5 kg.
 Energy units: 6 joules per cm³
 Number of blows per layer: 25
 Thickness of layers: approx. 4 cm
 Number of layers: 3
 Height of drop of tamper: 30.5 cm

FIGURE 257: EQUIPMENT FOR THE STANDARD PROCTOR TEST

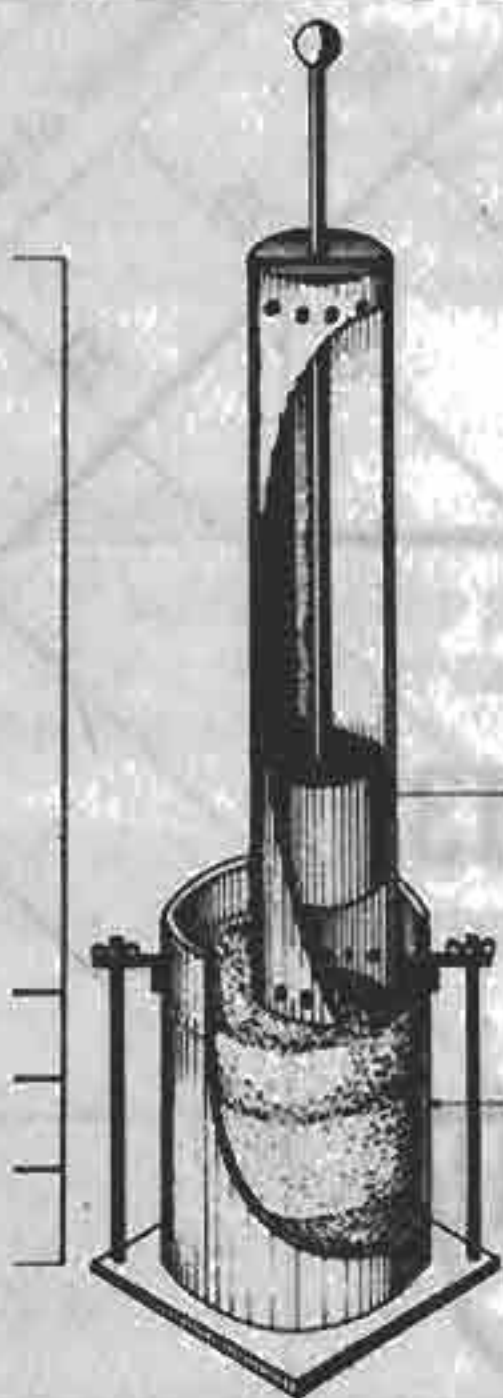

CRA Terre

FIGURE 259: CHECKING THE IDEAL MOISTURE CONTENT ON SITE

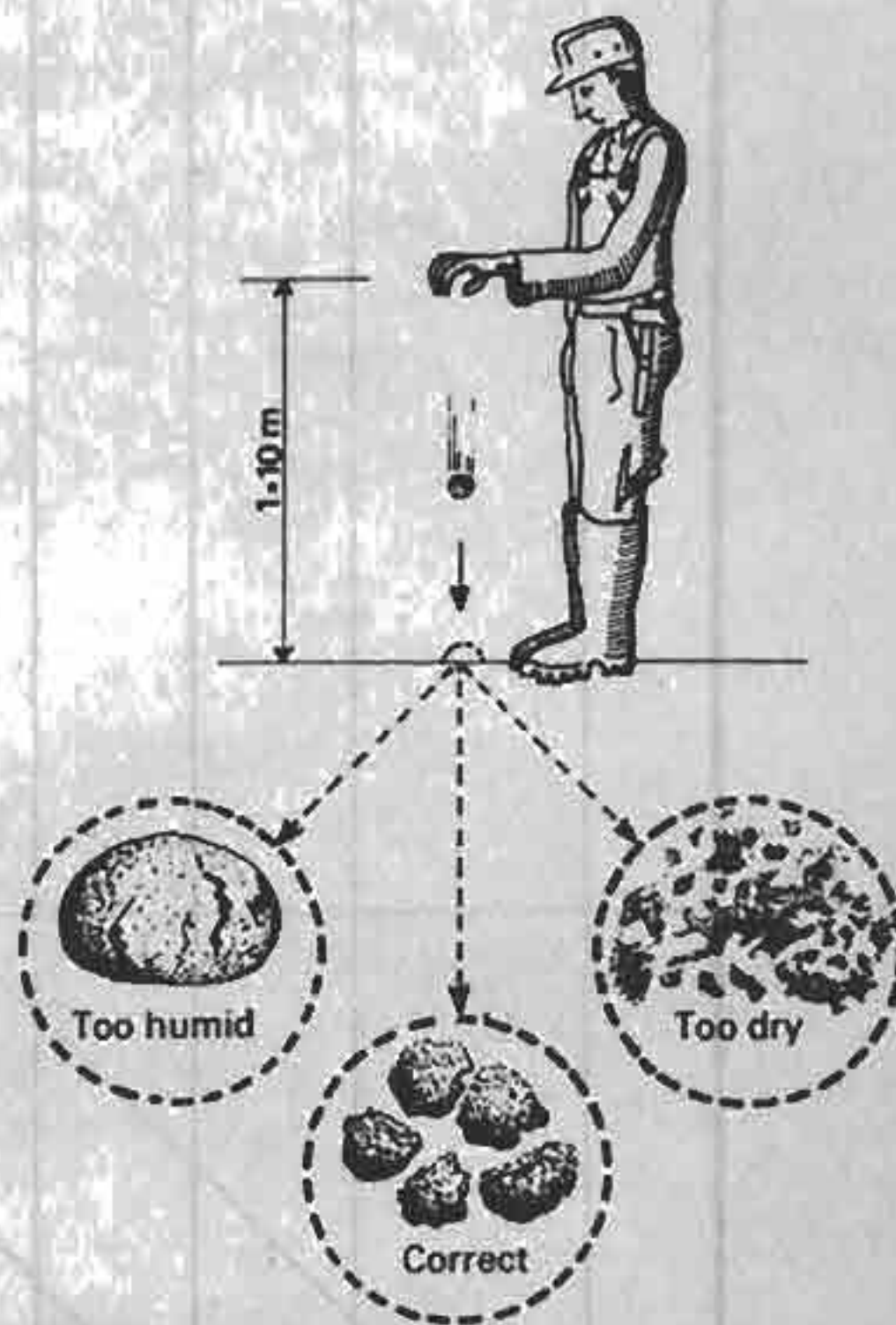

CRA Terre

Figure 257 gives the standard Proctor test characteristics. This test is quite well suited to rammed earth and to press-compacted blocks.

b) - Interpreting Proctor test results:

If the dry volume mass obtained at O.W.C. is within the range 1650 to 1760 kg/m³, the result is fairly poor; between 1760 and 2100 kg/m³, the result is very satisfactory, the material contains sufficient clay. Between 2100 and 2200 kg/m³, the result is excellent, the material is rich in large components. Between 2200 and 2400 kg/m³, the result is exceptional.

O.W.C. (%)	Evaluation	Stabilization potential (see corresponding chapter)	Usual stabilizer	
from 7 to 9	Good		cement	
from 9 to 17	Excellent	easiest to stabilize		
from 17 to 22	Acceptable	difficult to stabilize	lime	
from 22 to 25	Possibly acceptable			

3) Site tests

Laboratory tests, precisely defined and standardized, require special equipment. The following tests on the other hand demand no special tools and can be carried out on site while samples are being collected. With experience, they provide qualitative data which allow a fairly subtle classification of soils to be made and enable a direct evaluation of their possible use. They are presented in a fairly arbitrary order, beginning with the simplest. This is therefore an inventory of the options available rather than a recommended selection.

1) SMELL

Organic soils have a musty smell, particularly when freshly-dug. This smell becomes stronger when they are wet or heated. In principle they should not be used for construction purposes.

2) CHEWING

This is an easy way of assessing the presence of sand, silt or clay: take a pinch of earth and chew it lightly between the teeth:

a) **Sandy soil:** hard sand particles feel disagreeably gritty between the teeth, even if the sand is very fine.

b) **Silty soil:** The silt particles are much smaller than those of sand and although they still feel gritty, the sensation is not disagreeable. Silt is a lot less gritty than sand.

c) **Clay soil:** the clay particles are not at all gritty. On the contrary, clay feels smooth and floury between the teeth. A small lump of dry earth containing a lot of clay will stick to the tongue and be difficult to work free.

3) OBSERVING THE SHINE

Take a small lump of slightly damp earth rolled into a ball and cut it in two with a knife. If the cut surface is shiny, the earth contains clay in a plastic state; if the surface is dull, it is likely to be silty.

4) TOUCH

A sufficiently accurate way of assessing the

main component of a soil is by touch.

Take a sample and remove the coarsest particles over 5 mm (gravel); knead or crumble the sample between the fingers and the palm of the hand. This enables one to assess the size of the components:

Sand: dry sand particles feel rough;

Silt: dry silt also feels rough, but less so; wet silt has average plasticity;

Clay: dry clay looks lumpy or consists in fairly large particles and is very resistant to crushing. Wet clay is plastic and sticks to the fingers. Sand-silty soils produce a clearly audible scratching sound when rubbed between finger and thumb close to the ear.

5) HAND-WASHING

Washing one's hands with earth as if with soap gives a certain number of clues. When wet, clayey soils have a creamy, soapy feel and it is difficult to rinse them off one's hands. Silty soils seem powdery and are not too hard to rinse off. Sandy soils rinse off easily.

6) VISUAL OBSERVATION

This gives one an idea of the proportion and the size of the minute particles making up the coarser constituents and, by deduction, of those of the finest constituents. However, the finest particles visible to the naked eye are those of 0.08 mm; individual grains of clay and silt are invisible.

7) SIMPLIFIED SEDIMENTATION TEST

Select a transparent glass beaker with an opening sufficiently large, but which can still be sealed with the palm of the hand.

This beaker should be cylindrical, with a flat base and a capacity of at least half a litre. It is filled with earth to a quarter of its height and then filled up with water.

Sealing the mouth of the beaker with the palm of the hand, the contents are thoroughly shaken, before placing the beaker on a flat surface.

After an hour, it is shaken once more and left to settle. 45 minutes later, the sand can be

observed to have settled at the bottom, then the silt, with the clay remaining in suspension at the top.

After 8 hours, the height of the different layers is measured: the total height of the sediments and that of each layer. This gives an indication of the proportions of each constituent of the soil (fig. 260).

FIGURE 260: SIMPLIFIED SEDIMENTATION TEST

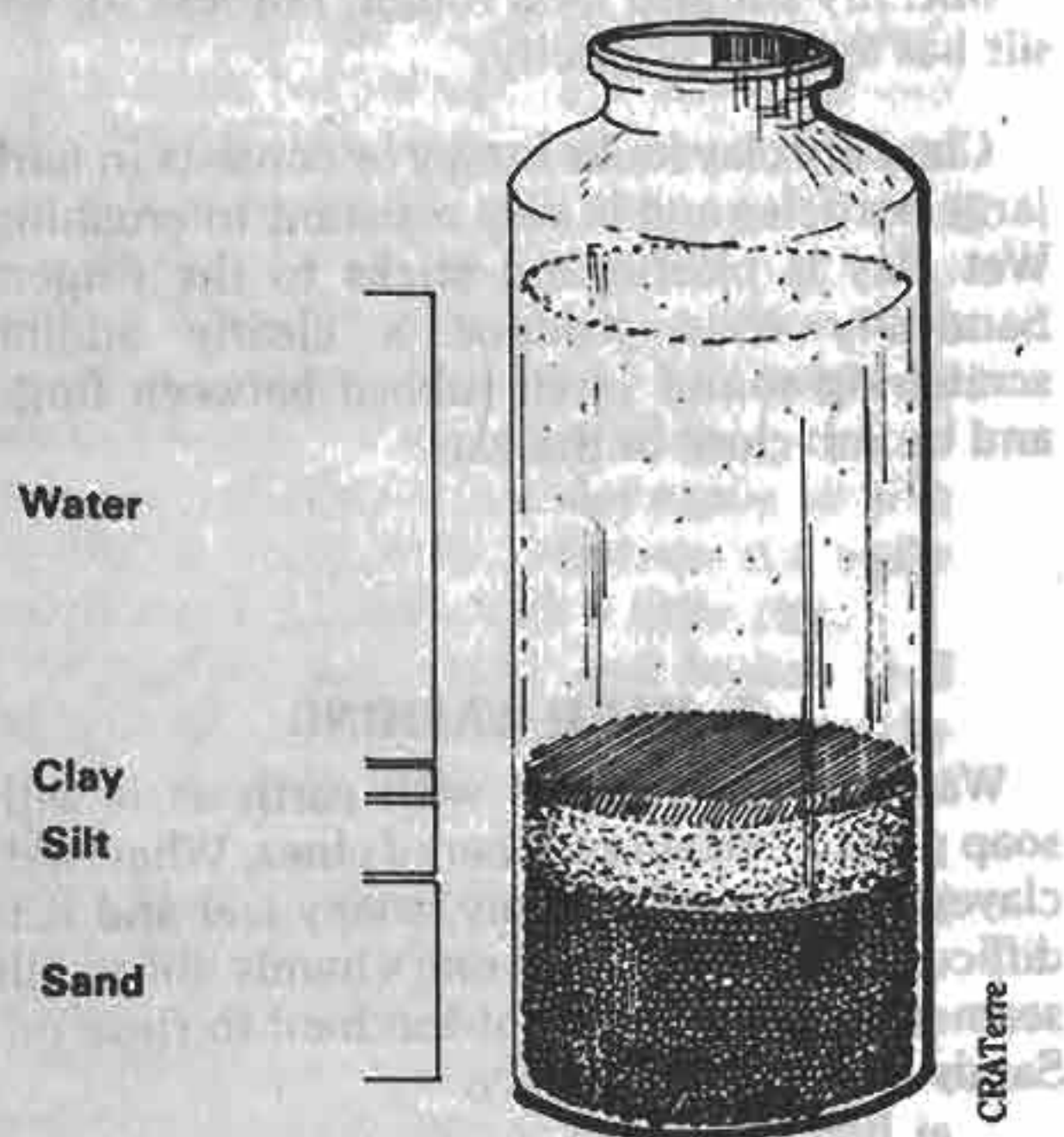

8) TESTS ON THE FINER SOIL COMPONENTS

The following tests are for the finer components which have therefore to be previously isolated by sieving or decanting.

● Decanting

This test begins in the same way as the "simplified sedimentation test" described above. The beaker containing the sample is vigorously shaken and then allowed to settle for 30 seconds. A rubber tube then serves to syphon off the all the water and the materials in suspension which are poured into shallow dish. This is allowed to settle until the water is clear. The water is then poured off, leaving the settled soil in the bottom of the dish. The remaining water left in the sample is eliminated by evaporation.

The syphoning will be easier if the rubber tube is completely filled with water and held closed at both ends with the fingers. One end has then only to be introduced into the beaker, whilst taking care that the other end is held

● Tapping (or seepage) test

Part of the settled sample is rolled in the palm of the hand to form a ball 2 to 3 cm in diameter. The soil should be sufficiently soft to allow the ball to hold its shape and not to stick to the fingers.

The ball is slightly flattened in the palm of the hand, which is held flat and the side of the hand is tapped sharply against the other hand several times. This will make the moisture seep out to the surface of the ball at which point the earth can appear smooth, shiny or greasy (fig. 261).

The earth is then squeezed between the thumb and index finger of the other hand and the affect of this on the ball is observed.

a) rapid reaction: only 5 to 10 taps are needed to make the water seep out. On squeezing the sample, the water immediately disappears and the sample becomes dull again. On squeezing still harder, the sample crumbles.

This suggests a very fine sand or coarse silt without organic matter. The presence of a small proportion of clay would prevent this reaction occurring.

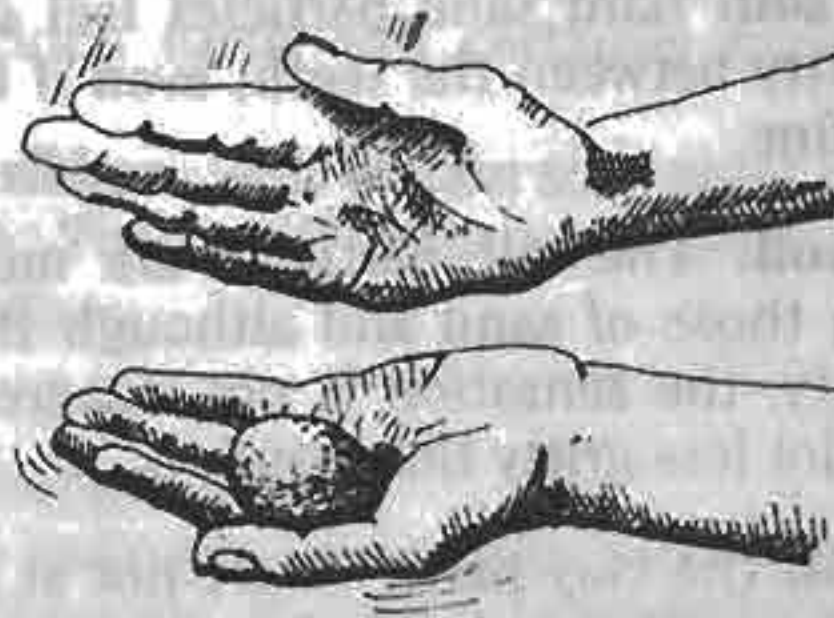

FIGURE 261: TAPPING TEST



b) slow reaction: it takes 20 to 30 taps before the water seeps out. Then when it is squeezed, the sample neither cracks nor crumbles, but rather flattens like putty.

This suggests a slightly plastic silt or silty clay.

c) **very slow or no reaction:** the more clay the soil contains, the slower the reaction. When it is squeezed, the surface remains shiny.

● String test

This test complements the tap test; it is not necessary to perform it if the latter has produced a "rapid reaction". Take a piece of earth the size of a large olive and wet it just enough for it to be easy to knead in the hand without sticking. Then on a clean flat surface carefully roll it out to form a "string" which gets gradually thinner.

If the string breaks before it has been rolled out to a diameter of 3 mm, the earth is too dry and a little water should be added. When the water content is right, the string will break up just when it reaches 3 mm (fig. 254).

If the piece of earth crumbles easily or if it fails to form a string at all, whatever the water content, the soil contains only a little clay.

If a string has been made and broken at 3 mm, quickly pick up the pieces and reshape the ball; then crush it between the thumb and forefinger.

a) **hard string:** If the ball is hard to crush and if it neither cracks nor crumbles, the soil contains a great deal of clay. It will probably not be usable on its own for earth construction.

b) **moderately hard string:** When the ball is squeezed between thumb and forefinger, it cracks or crumbles. The soil may be alright for construction.

c) **brittle string:** When the soil has a great deal of silt and little clay, it is impossible to reshape a ball without it breaking up and crumbling. Such soil is suitable for earth walls.

d) **soft, spongy string.** Sometimes, the strings and balls are soft and the balls feel spongy between the fingers. This means that the earth is organic and is not suitable for building.

● Ribbon test

This test complements the string test. Take enough earth to make a roll the size of a cigar of 12 mm in diameter. This earth should not be sticky, but should be moist enough to be able to roll it out into a 3 mm diameter string as for the previous test.

Taking the roll in the palm of the hand and starting from one end, flatten it between the thumb and forefinger to shape a ribbon of 3 to 6 mm in width (fig. 262). Handle the sample carefully in order to allow the ribbon to be as long as possible. Measure the length which can

be obtained before the sample breaks up.

a) **long ribbon:** with certain soils the ribbon can reach 25 to 30 cm without breaking. This suggests that the soil contains a great deal of clay. It can be used but will need stabilizing.

FIGURE 262: RIBBON TEST

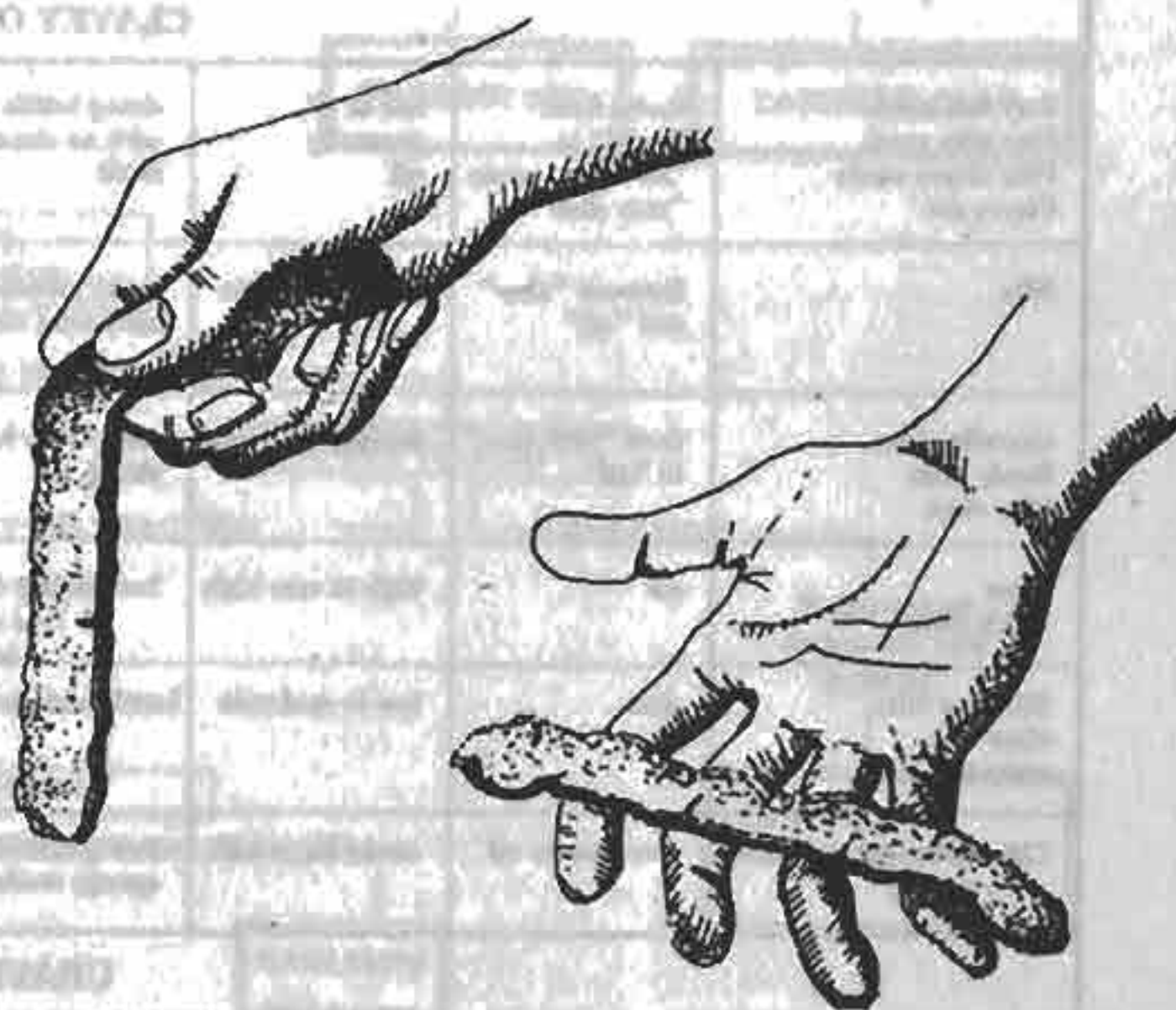

CRATerre

b) **short ribbon:** if one has difficulty in producing even a 5 to 10 cm ribbon, the earth has a weak or medium clay content and will be similar to those giving a moderately hard or brittle string. Such earth will certainly make good walls;

c) **no ribbon:** with certain soils no ribbon can be made. These will make very good rammed earth walls.

● Dry strength tests

These tests are also carried out on the fine soil components. Prepare two or three pellets of soft earth of approximately 12 mm in width and 25 to 30 mm in diameter. Dry the pellets in the sun and then in an oven.

Break the pellet and try to powder it between the thumb and forefinger:

a) **high dry strength:** it is very difficult to break the pellet, it splits with a crack, like a dry biscuit. The earth cannot be squeezed between the thumb and forefinger. This indicates an almost pure clay;

b) **moderate strength:** it is not difficult to break the pellet. Without too much effort, it can be reduced to powder by squeezing it between thumb and forefinger. This indicates a silty or sandy clay;

c) **low strength:** there is no problem in breaking the pellet which is quickly reduced to 181

powder. This indicates either silt, or very fine sand, or a soil which contains a small quantity of clay.

The table below gives some idea of the potential for use for construction purposes of soils tested.

TYPES OF SOIL	TAPPING TEST	DRY STRENGTH	STRING TEST	RIBBON TEST	POTENTIAL FOR USE	STABILIZERS
CLAYEY OR SILTY SOILS						
Very fine sands Fine silty sands Fine clayey sands Clayey silt	Varies from "rapid" to "slow" but never "very slow"	low to nil, generally nil	string brittle or with no strength at all		suitable for all types, particularly adobe, if stabilized	cement best bitumen emulsions and water-resistant products suitable.
Silts	Between "slow" and "nil"	low to moderate	brittle, moderately hard string	Short ribbon	Avoid using if possible if not, add a great deal of stabilizer	Cement, bitumen emulsions if the soil is not too sticky, water-resistant products suitable.
Gravelly clays Sandy clays Silty clays	from "very slow" to "nil"	moderate to high	moderately hard string	ribbon short to long	will usually need a stabilizer; suitable for rammed earth and compressed bricks	lime, add sand or gravel; water-resistant products suitable.
Clays Thick clays	nil	high to very high	hard string	long ribbon	should never be used for building an earth house.	
Silts and Silty clays with organic matter	slow	low to moderate	brittle and spongy	Sh. Fib. of no ribbon	should never be used for building an earth house.	
Clays with organic matter	very slow to nil	moderate to high	string brittle to spongy moderate	short ribbon with spongy consistency	should never be used for building an earth house.	
GRAVELLY SOILS						
Silty gravels Mixes of gravels, sands, and silts	rapid	low to nil (generally nil)	string lacks strength	no ribbon	generally suitable if stabilized. If the gravel is almost clean, fines can be added first	Cement best; bitumen emulsions might also be suitable, water-resistant products.
Silty gravels mix of gravels, sands and clays	Slow to very slow	Moderate	moderately hard string	short ribbon (sometimes long)	Can be very suitable for all types of earth construction. If the gravel is too clean, fines can be added	lime preferable, cement can be suitable if the mix is easily blended, water-resistant products.
SANDY SOILS						
Silty sands	rapid	low to nil (generally nil)	string with no strength	no ribbon	generally suitable if stabilized. If the sand is almost clean, fines can be added	cement preferable. Bitumen can also be used. Water-resistant products.
Clayey sands	slow to very slow	moderate	moderately long strings	short ribbon (sometimes long)	generally very good for all types of earth construction	lime best; cement suitable if the mix is easily blended. Water-resistant products.
Pure sand					not suitable for earth construction unless fines are added.	

* Source: reference 7

Quick clay identification test (Emerson test)

The Emerson test is conducted on a piece of earth the size of a pea. This placed in a glass receptacle full of distilled water or rain water. It is important that the piece of earth should not have been unduly handled before being immersed.

182 After ten minutes in the water, the piece of

earth will either still be intact or have disintegrated. The way in which it reacts gives a rudimentary indication of the nature of the clay. This test, which we have not personally tried out, should never be used as a substitute for a thorough mineral analysis.

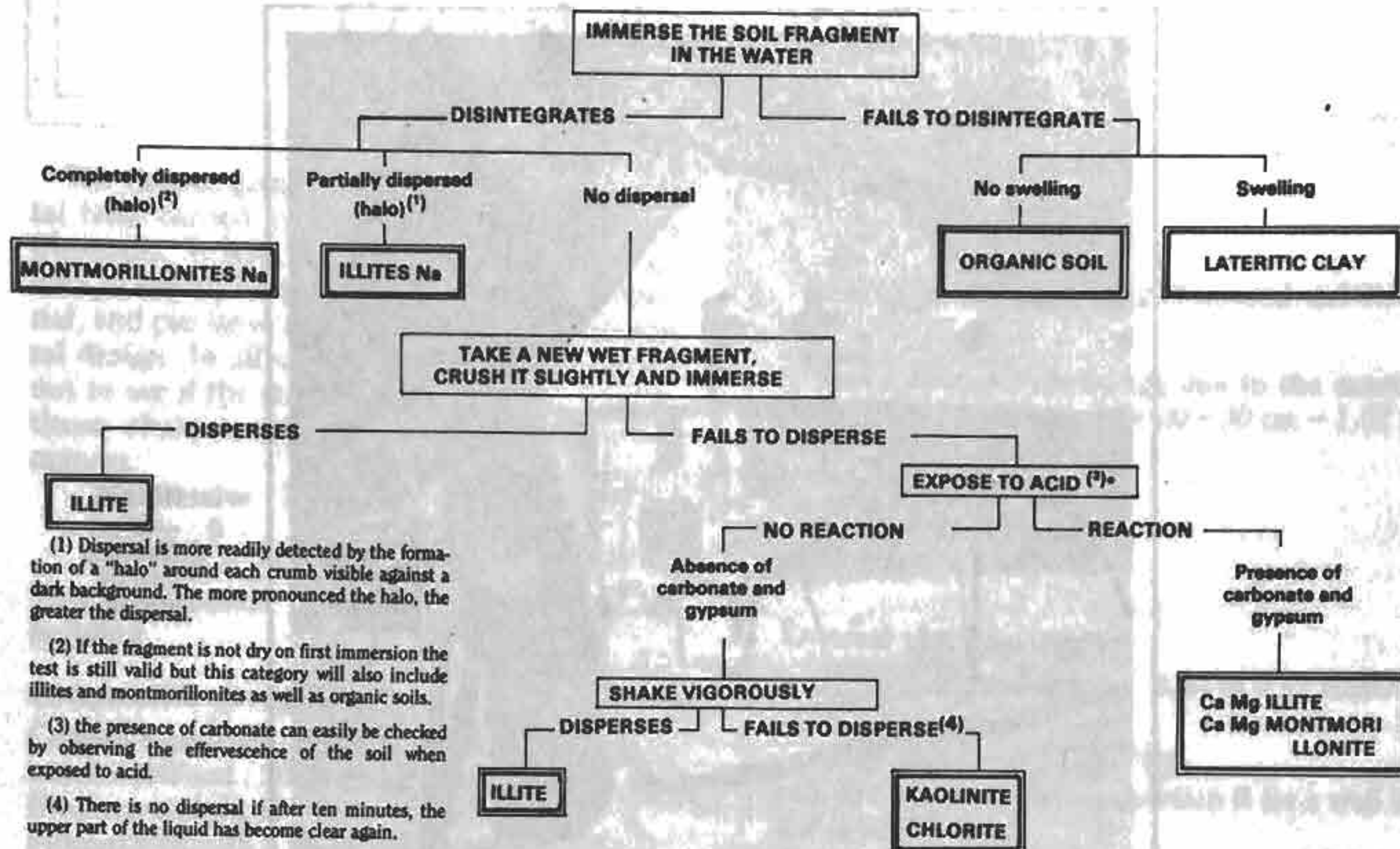

Principle soil components and their physical properties

Name of type	Main minerals present	Size of particles	Physical properties
Very pure sand, Silica	Quartz	$> 1 \mu$	Lacks cohesion, abrasive
Mica	Muscovite	$> 1 \mu$	Lacks cohesion
Carbonate	Calcite, Dolomite	variable	
Sulfate	Gypsum	$> 1 \mu$	liable to attack certain cements
Clays	Kaolinite	$\approx > 1 \mu$	no swelling, low plasticity, little cohesion
	Illites and Micaceous partially worn	variable	swelling, moderate plasticity
	"bentonite" and inter-stratified Montmorillonites	$\leq 1 \mu$	very liable to swell, very plastic
	Chlorite, Vermiculite	$\approx 0.1 \mu$	limited swelling
Organic matter	are not mineral	none	fast disintegration

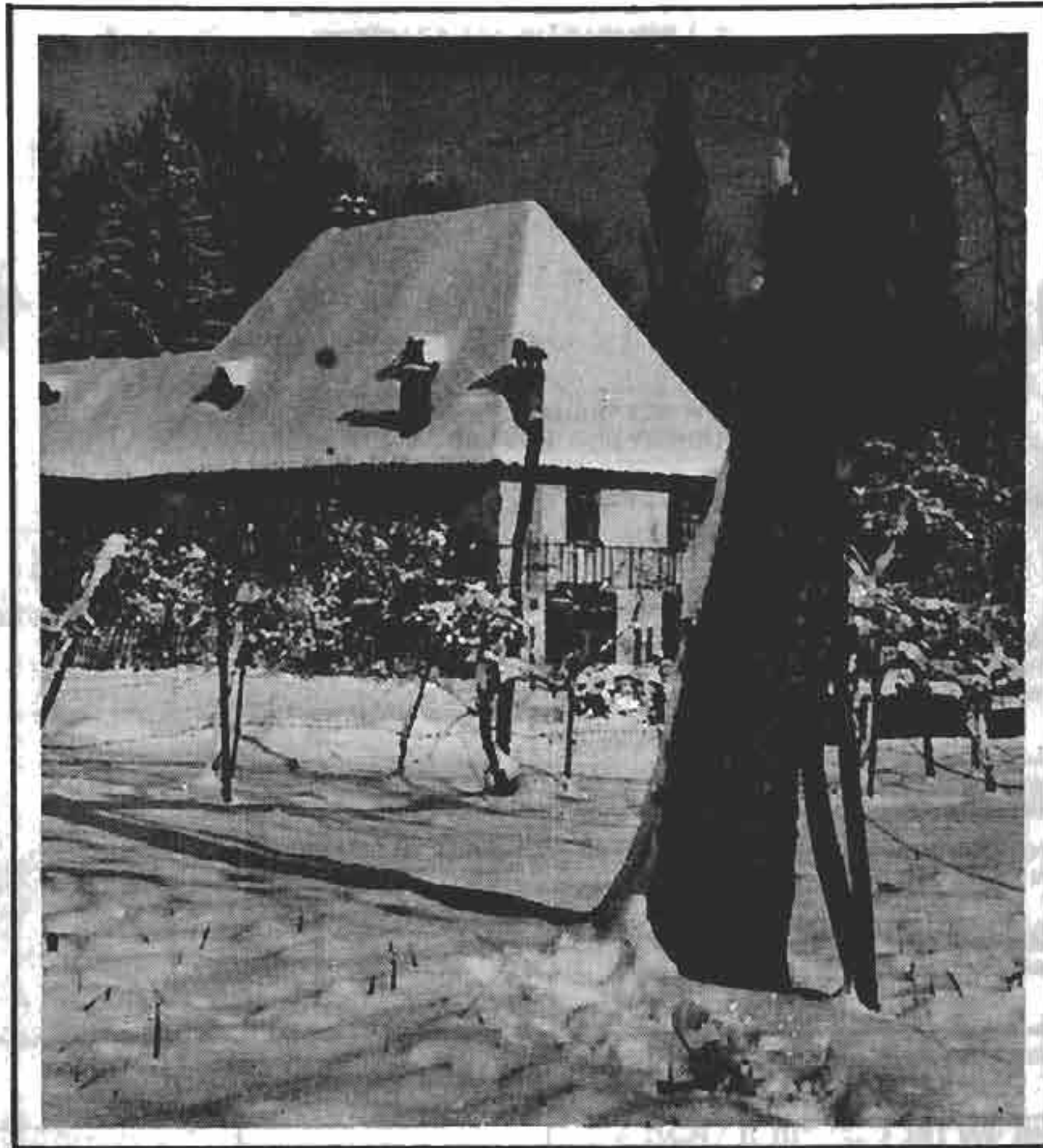

HOUSE
OF
RAMMED
EARTH
(ISERE)

Dominique Pierre

6. THE CHARACTERISTICS OF EARTH AS A BUILDING MATERIAL

At present there are no accepted norms for all the methods for the use of earth in building. Only the industrialized countries have perfected precise tests for the minimal performances of the material with regard to adobe and tamped stabilized earth (in moulds). These norms define the minimum strength and durability to be achieved and thus allow contractors and insurance companies to offer the guarantees required in the context of monitored production.

Other techniques, such as direct moulding, rammed earth (in shuttering) and traditional adobe, have no norms, which is to say that the builder has no access to regulations specifying their method of use and at the same time giving him legal "cover" in the event of damage. There are, however, recommendations made by various sources which he can use as a guide.

General characteristics

The figures given are drawn from experimental tests carried out by different organisations (Australia, U.S.A., France, etc.) They give an idea of the technical performance of the material, and can serve as the basis for an architectural design. In all cases, tests should be carried out to see if the results obtained correspond to these characteristics. Recommended performances:

- compressive : 2 kg/cm²
- tensile : 0
- shearing: 0.3 kg/cm²

This corresponds to those of a single-storey building.

Compressive strength:

- Cement-stabilized : 50 to 100 kg/cm²
- Lime-stabilized : 30 to 80 kg/cm²
- Bitumen-stabilized : 15 to 60 kg/cm²
- Fibre-stabilized : 5 to 20 kg/cm²
- Stabilized with chemical products: 20 to 40 kg/cm²
- Stabilized with powerful chemical products: 150 to 400 kg/cm²

Wet compressive strength:

Approximately half the dry compressive strength.

Tensile strength:

(Brazilian test), 1/5 of the compressive strength.

Young's modulus

7,000 to 70,000 kg/cm²

Permeability:

1×10^{-6} cm/second.

Linear shrinkage on drying of tamped stabilized earth: 2mm/m.

Linear horizontal shrinkage due to the mortar of a wall built of bricks 30 × 30 × 30 cm = 1.07 to 2 mm per 5 m.

Thermal expansion:

0.012 mm/m per °C.

Thermal characteristics:

coefficient of conductivity : 0.44 to 0.57 Kcal/h m °C

specific heat C = 0.2 Kcal/kg

overall coefficient of transmission K for a wall in stabilized earth:

20 cm wall:

- 1.6 Kcal/h m² °C 1.30 W/m² °C

30 cm wall:

- 1.2 Kcal/h m² °C 1.00 W/m² °C

40 cm wall:

- 1.0 Kcal/h m² °C 0.86 W/m² °C

50 cm wall:

- 0.8 Kcal/h m² °C 0.70 W/m² °C

Damping for a 40 cm wall.

m = 10%

time lag for a 40 cm wall: 8 to 12 hours.

Acoustic characteristics

40 cm wall: attenuation for a frequency of 500 HZ = 56 dB.

Standardized tests

These tests are taken from the stabilized adobe building specifications of the U.S.A.

Compression test:

This test is carried out on cylindrical test samples 5 cm in diameter and 5 cm high. The samples are treated in the same way as the material

to be tested: wet moulded for adobe, compaction for rammed earth and compressed blocks.

After initial drying intended to avoid shrinkage cracks, the test samples are placed in an oven at 66°C until their weight remains constant. Then to ensure that the surfaces supporting the sample are parallel a layer of plaster is laid on the upper surface and inner surface of

the cylinder. The test samples are then tested with a special machine or any other equivalent system. The tests are conducted on 5 samples and the average calculated. The pressure applied on the testing machine can vary from 500 kg for the weakest samples to 1500 kg for the strongest samples.

Bending strength (modulus of rupture)

Larger samples or complete bricks can be tested for bending. They are placed on two parallel tube supports spaced 25 cm apart. A concentrated force is applied to a horizontal tube placed in the middle of the block to be tested, i.e. 250 kg per minute. The force necessary to break the brick is noted. The modulus of rupture can be calculated using the following formula:

$$R = \frac{3}{2} \times 25 \times \frac{P}{w \times h^2}$$

R = modulus of rupture in kg/cm²

25 = distance between the two supports in cm

w = width of the brick

h = height of the brick

To establish the modulus of rupture the average of 5 tests is taken.

Water absorption:

Five cubic samples with 10 cm sides are cut from the sample. They are dried in an oven until their weight remains constant. Their water loss is recorded (water content). After cooling, the samples are placed on a porous surface and continuously saturated with water, in a humid environment. After 7 days the increase in weight of the

samples is measured and expressed as a percentage of their dry weight. The absorption rate taken is the average of 5 samples.

Erosion:

An earth block of whatever size (a whole brick for example) is placed on a grill opposite a watering hose. The brick is stood on end 17 cm from a shower rose which sprays it with a horizontal jet at a pressure of 1.6 kg/m for two hours. The weight loss of the brick and the depth of the holes can then be measured. In the majority of cases these results are indicative only and slight erosion or a spattered surface should not be interpreted unfavourably.

Wetting - drying cycles (ASTM norms D 559-44 and D 560-44)

Prepare three test samples A, B, and C. A will be used to study variations in volume and water content, B and C will be used to determine the weight loss of the material after each cycle.

The test samples are dried in the open and subjected to a series of 12 cycles including:

- 5 hours' immersion at the end of which test sample A is measured and weighed
- 42 hours' drying in the oven at 60°C.

Test sample A is measured and dried, whereas samples B and C are brushed (4 brush strokes at the ends, 18 to 20 along the sides). They are then weighed. The entire cycle should not exceed 48 hours.

The cycle is repeated 12 times running and the samples are then dried at 100°C until their weight remains constant.

The maximum loss of weight permissible after 12 wetting cycles is 10%.

Norms and recommendations

UBC 1958-(Uniform Building Code U.S.A.) For stabilized adobe:

- compression (minimum): 24 kg/cm²
- modulus of rupture (mini): 4 kg/cm²
- water absorption in 7 days (maxi): 2.5% of dry

- water content (max): 4% of dry weight
 - erosion: average depth of holes, 0.15 cm
 - cracks: no cracks exceeding 3 mm wide and 7.5 cm long. No more than 3 cracks per brick.
- REEF (CSTB)** (France 1945) for stabilized tamped earth.

- compressive strength: 15 kg/cm²
- working rates: external walls,
1 kg/cm²
internal walls,
2 kg/cm²

modulus	safety coefficient
16	41
14	25
10	18
6	12

O.N.U. recommendations (inter American Housing and Planning Center: CINVA)

- Wet strength (mini): 14 kg/cm²
- Weight loss after 12 cycles of wetting-drying:
- urban buildings: 5% for all climates; 10% for dry climate;
- simple rural buildings: 10% for all climates and dry climate.
- Walls: the wall modulus is defined by the relationship between the height and the thickness.
- the modulus should remain below 18.
- Safety coefficient for compressive strength depending on the modulus of the wall.

Recommendations for stabilized adobe (Peru)

- compressive strength:
 - 17.6 kg/cm² : Good
 - 17.6 to 14 kg/cm² : Marginal
 - less then 14 kg/cm² : Bad
- modulus of rupture: 3.5 kg.cm² : Good
less than 3.5 kg.cm² : Bad
- water absorption: 2% or less : excellent
2 to 3% : good
3 to 4% : passable
4% and over: insufficient.

Middleton recommendations (Australia)

The ratio of the thickness of load-bearing walls at their base to the overall height of the wall should be no less than 1:18.

Traditionally builders respected the guideline that openings (doors and windows) should not take up more than one third of the surface area of the wall. This guide is a little simplistic and

too restrictive (except in earthquake zones) and can be refined by more sophisticated data. Earth walls being particularly vulnerable to horizontal stress caused by windows slamming on days of high wind. The following table give the maximum length of walls between reinforcing points (corners, external buttresses or partition-walls).

For a wall width (in m)	0.30	0.35	0.40	0.45
and height : 1 story (in m) in the range	2,75/3	3/4	3/5	3/5.5.
2 stories (in m) in the range	4/5	4/6	5/6.7	5/7.3
The maximum length between two reinforcing points (in m) will be:				
Wall without opening	9	10.75	12	13.75
Wall with one or more openings reaching no further than 1.4 m from the center of the wall, measured horizontally	7.3	8.5	9.75	11
Walls with a single opening near an edge reaching no further than the middle of the wall	6.5	7.5	8.5	9.5
Wall with a group of openings or a single opening up to 3.6 m wide.	5.5.	6.5	7.3	8



CRATerre

RAMMED EARTH CHATEAU IN THE SAONE VALLEY

7.

STABILISATION

Building with earth implies a fundamental choice between:

- 1) Using the soil available at the site, and therefore designing the project to take account of the qualities of this material.**
- 2) Obtaining a better quality soil.**
- 3) Improving the characteristics of the local soil to create a perfectly suited material.**

The first two options not always being acceptable, the last will often be the only possibility. **SOIL STABILIZATION** is the general name we give to the processes used to improve the characteristics of soils.

Definition and natural laws

A stabilization process can be defined as a physical, physico-chemical, or chemical method enabling a soil or earth better to meet the requirements which arise from its use in building work. To solve a stabilization problem it is therefore necessary to know:

- the properties of the earth to be treated
- the improvements sought
- the products, materials and procedures which can be used
- the various application technologies
- the practical limitations such as cost and time available
- the maintenance conditions of the building once in use.

A good solution will have been achieved if, on the basis of these various considerations, a process can be put forward which will substantially improve the properties of the soil thanks to an optimum technology which is compatible with the time available for completion, the costs of implementation and maintenance, and all the other determining factors of the programme. All this gives some idea of the complexity of the issue which would in itself justify a separate manual dealing only with stabilization. Our aim is less ambitious, and is restricted to presenting the principle solutions generally adopted by briefly describing them.

Stabilization, which has been used for many years, offers a wide range of applications linked to civil engineering, and whatever the application involved it meets a limited number of objectives:

- reducing the volume of the spaces between the solid particles (porosity);
- filling the spaces which cannot be eliminated (permeability);
- binding or improving the existing binding between particles (mechanical strength).

These three objectives allow the mechanical properties of the material to be improved and its susceptibility to water to be reduced, these effects including swelling and shrinking, loss of cohesion and rigidity, erosion, frost damage. It goes without saying that the improvements obtained should be permanent.

These few principles can be fairly easily illustrated by the following examples:

Sand: Sand is a powdery material. Sand particles move very freely: on the beach a dry sand-

castle will not stand up; similarly, cars are liable to get stuck in sand (fig. 263).

A small amount of water links the grains of

FIGURE 263:

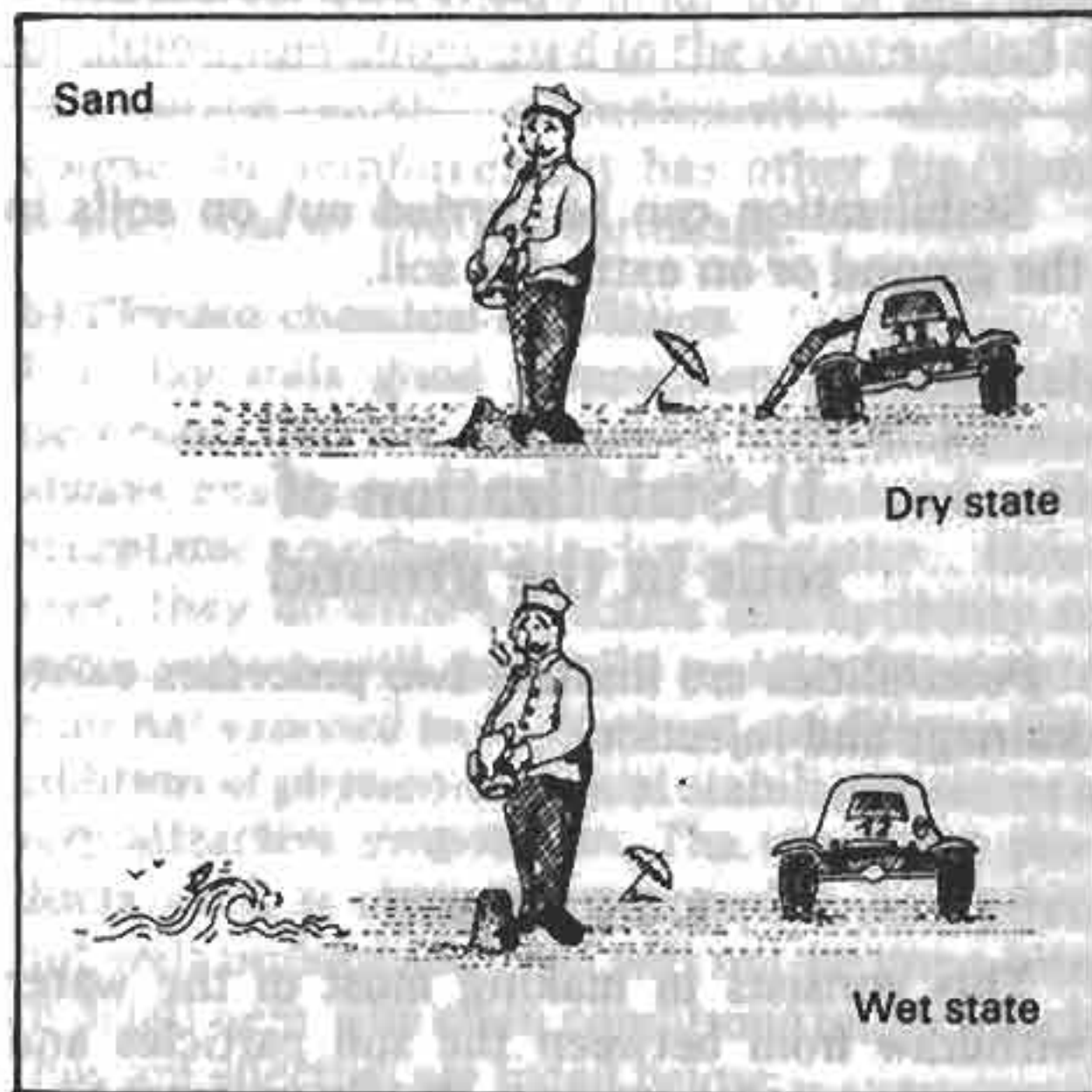

CRATerre

castles together: wet sand is a cohesive material with which one can build magnificent castles and on which it is possible to drive a car, until the sun and the wind dry it out and destroy its cohesion.

Clay: as it contains a certain amount of water, clay is malleable, plastic and can be shaped: it has a certain degree of cohesion. When it dries, this cohesion increases: the clay hardens. Wetting it again results in loss of cohesion, erosion (fig. 264).

These fundamental properties are exploited

FIGURE 264

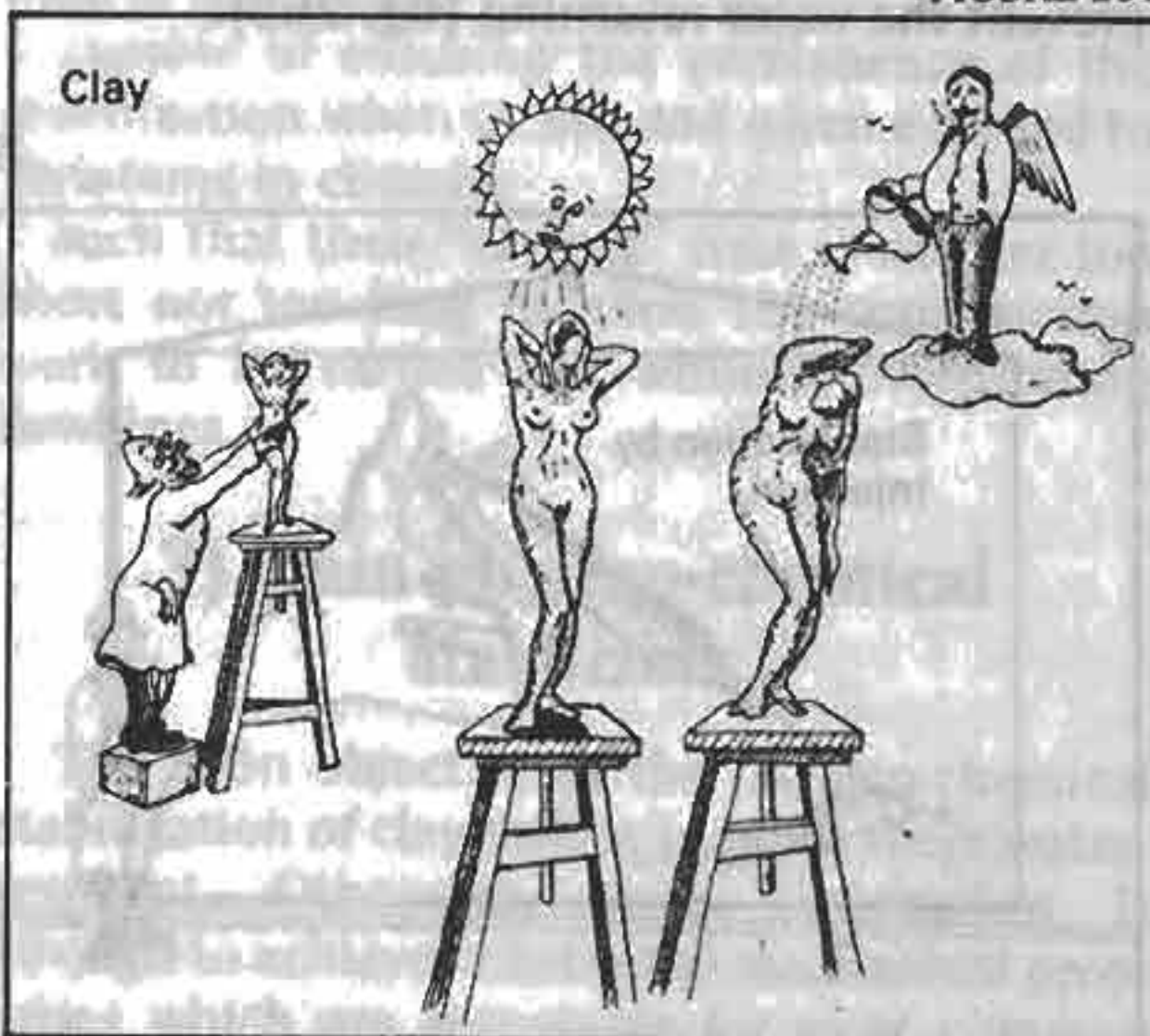

CRATerre

by the various processes used for earth building. Sun-dried bricks use the increase in cohesion of dry clay. With rammed earth this increase in cohesion is associated with limiting the shrinkage which occurs as a result of the presence of

coarser materials (sand and gravel). In the case of S.S.C. (Stabilized Soil Concrete), the presence of a binding agent (cement, lime, bitumen) tends to make the improvements to the products permanent.

Stabilization in practice

Stabilization can be carried out on soils in the ground or on extracted soil.

1) Stabilization of soils in the ground

Possibilities are limited; two processes exist: drainage and injection.

1. DRAINAGE

This consists in making most of the water withdraw from between the soil particles and preventing its later return. It takes a long time to achieve on soils with a high proportion of fines, silt and especially clay, although it is precisely on these types of soil that it achieves the best stabilizing effects. The withdrawal of the water results in shrinkage of the soil and reinforcement of the links between particles.

2. INJECTION

This consists in replacing most of the water located between the soil particles with a product which fills the gaps and must remain there to prevent the water returning (fig. 265).

The product injected has therefore to be fluid in order to penetrate into the material. It has also to "set". If once it has set it also adheres to the soil particles it will result in much better stabilization. The main products injected are clays, essentially clogging, and various types of lime and cement which fill the spaces and improve the links between particles. These products are in powder form and have to be mixed with water to make the injection "fluid".

As they are not, however, sufficiently fluid to allow the injection of fine-grained soils, which are not very permeable, products which produce a far more fluid result when mixed with water are used for these soils: these include notably silicates and some resins.

2) Stabilization of extracted earth

In these processes the earth has to be extracted from one area for use in another. The successive operations required in the course of this makes stabilization much easier. As earth construction (of dams, dirt-tracks, roads and buildings) mostly uses extracted earth, this form of stabilization is immediately relevant.

FIGURE 265

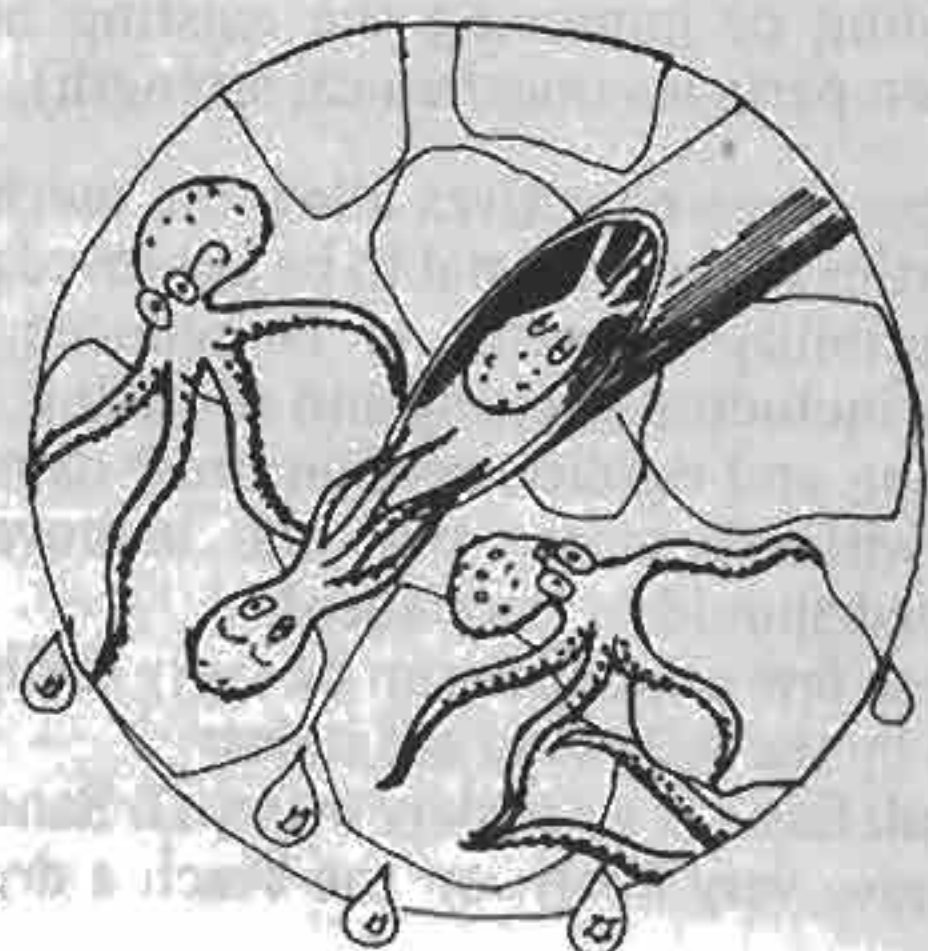
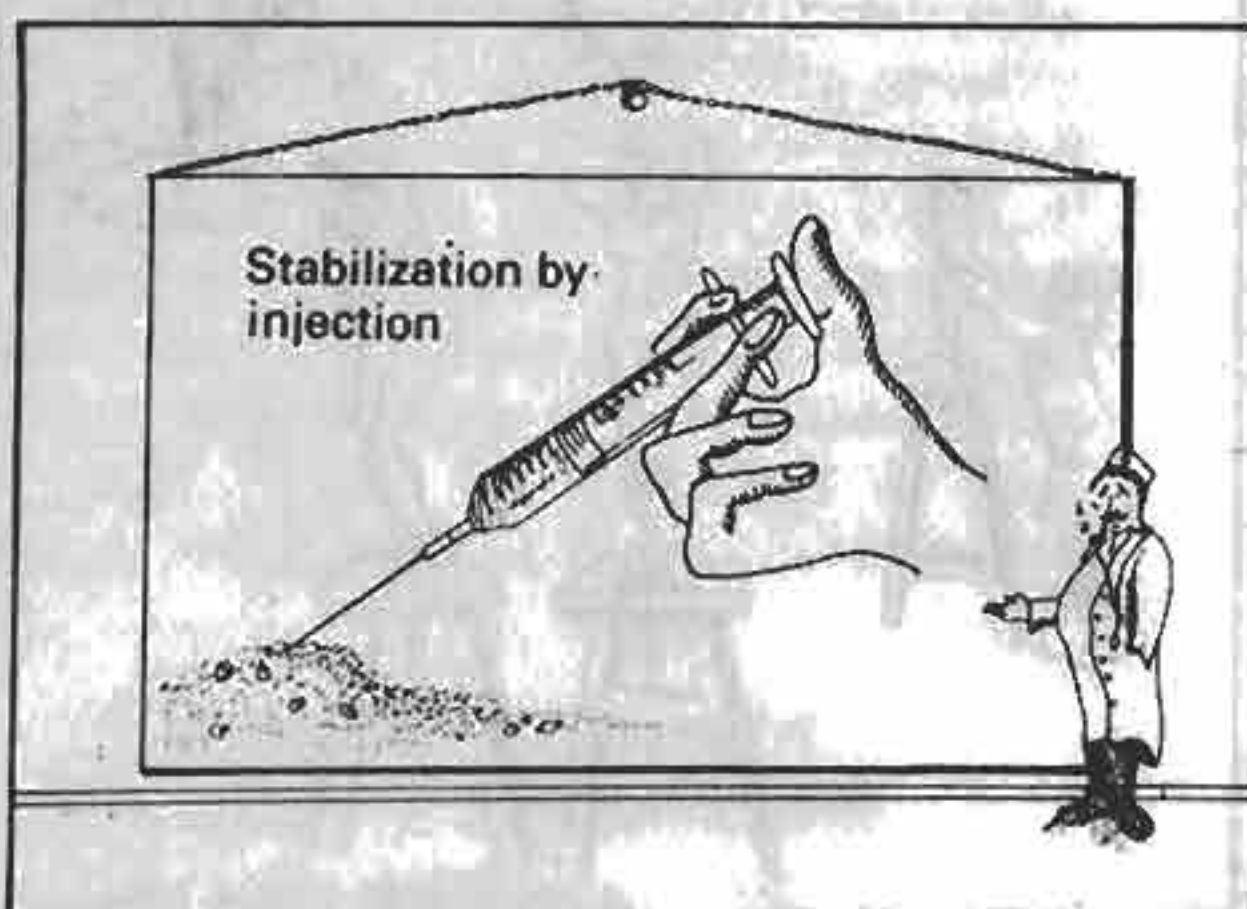

1. STABILIZATION WITHOUT USING A STABILIZER

This consists essentially in reducing the porosity of the material by tightening up the particles.

a) **Compaction.** A mechanical process increases the density of the material. This process can be:

- static: cylindrical rollers, ridged rollers, wheeled rollers... Presses and brick production belts.

- dynamic: vibrating rollers. Vibrating pick hammers and formwork. Tampers and rammers.

- complex: projection and crushing.

The effectiveness of the compaction will depend essentially on the particle distribution of the material and the type of compaction used. Static processes are generally more effective with soils rich in fines, whereas for soils rich in coarse elements vibration is more effective. Hence the fact that presses are perfectly suited to the production of clay bricks, whereas fresh cement, which contains a lot of gravel, can be efficiently densified with vibrating rammers.

The compaction force and the water content are also critical factors. A standard test (the PROCTOR test) has been defined to determine the water content corresponding to the greatest density. This water content is known as the Proctor optimum.

Compaction, by reducing the porosity of the material, improves its characteristics. But it should be noted that if this is the only method of stabilization used, the improvements obtained will not be permanent for fine materials. Any earth construction will in the end deteriorate as a result of exposure to water, which means that it needs to be protected; hence the relevance of products which when added to the earth reduce its susceptibility to water, i.e. stabilizers.

b) **Desiccation.** Drying fine materials without compacting them, if care is taken to avoid undesirable side-effects (cracking), can increase the cohesive strength of a material. This property would appear to play the key role in construction techniques which use balls or bricks of earth. The result obtained is comparable to that of a slight compaction but to avoid shrinkage cracks appearing the size the balls used must remain small. Hence the advantage of good compaction which reduces the risk of shrinkage cracks.

2. STABILIZATION WITH THE HELP OF A STABILIZER

a) Chemically inert stabilizers

These are materials which when added to the soil reduce the negative effects of shrinkage. They are:

- Sand and gravel the widely-known beneficial effects of which are particularly well exploited in rammed earth.

- Vegetable or animal fibres, very effective, cheap and easy to use in brick-making.

- Reinforcement: Straps made out of polymers or aluminium alloys used in the construction of "reinforced earth" embankments; where of course the reinforcement has other functions besides that of limiting shrinkage.

b) Physico-chemical stabilizers

For clay soils good compaction is absolutely necessary and the addition of inert stabilizers always enables one to obtain a material with acceptable mechanical characteristics. However, they do little to reduce susceptibility to water, which will generally rapidly deteriorate material exposed to it. In these conditions, the addition of physico-chemical stabilizers seems a very attractive proposition. The way these products work is always very complex, and often not well understood, and will not be gone into in detail here. The main conditions under which they are effective are listed below:

They should be:

- effective at low concentrations (less than 10% of the dry weight of the soil);

- usable with simple equipment. Water-soluble or mixable products are of particular interest;

- available at a price compatible with the benefits they bring and which justifies the use of earth compared with any other material;

- effective over a wide range of soils. It must also be said, however, that at present there is no universal "miracle stabilizer" and that preliminary tests are always required;

- effective whatever the water content at the time of treatment;

- capable of ensuring the permanence of the stabilization when in use and when exposed to variations in climate;

- such that their "setting" time is neither too short nor too long to allow the construction work to be carried out without overrunning deadlines.

3) Main physico-chemical stabilizers

The main objective of the physico-chemical stabilization of clay soils is to make them water-resistant. Otherwise, good compaction is enough to achieve substantial mechanical properties which are acceptable for most common

uses. As for water-resistance, it can most particularly be obtained thanks to products making clay less absorbent.

HYDROPHOBIC AGENTS

a) **Amine derivatives:** These are derived from ammonia, and are ammonium salts or amines in solution in an organic solvent which should be diluted in water (e.g. "Aliquad"). They work well in very low proportions: 1% or less.

b) **Resins:** The most commonly quoted reason for using these is that they induce the formation in the soil of a strong membrane as a result of the polymerism of the resin. This cementitious effect is very often accompanied by a reduction in the susceptibility of the earth to water, which justifies their being placed squarely amongst hydrophobic agents. The following can be used:

- Abietic resins, which can come from the waste-product of wood processing during the manufacture of paper pulp.

- Furfural aniline and resorcinal-formaldehyde resins the essential role of which remains cementation.

Although the way they work is not well understood, resins deserve some attention as they work at very low concentrations. Moreover as they are frequently derived from vegetable products, their production and use in areas where other stabilizers would have to be imported is realistic.

c) **Bitumen and hydrocarbons:** Bitumen emulsions or fluidized bitumen (cut-back) can be used for stabilization.

BINDING AGENTS

As far as the physico-chemical stabilization of low clay-content soils is concerned, because these are fairly water resistant and have poor cohesion, one objective will be to use a product (known as a binding agent) the properties of which will predominate over those of the soil itself. Binding agents can also be used on clay soils when exceptional mechanical characteristics are required.

Non-hydraulic lime:

a) **Quicklime and hydrated (slaked) lime:** Used to stabilize fine clay soils, limes used in proportions of 4 to 10%, generally produce a significant improvement in the mechanical properties of the material. Thus compressive strength can easily be increased by a factor of 4 or 5. The use of quicklime makes it possible to use soils which had too high a water content on extraction. This is because when in contact with the

water in the soil, quicklime changes into hydrated lime (by extinction) thereby proportionately reducing the water content of the soil. This thus obviates the need to dry the soil. Lime only hardens in contact with air, when exposed to carbonic gas, which can virtually not take place within walls or compacted blocks. The addition of secondary products with pozzolanic properties (pozzolanas, whiting, fly ash...) lends lime a certain degree of hydraulicity and allows very significant increases in mechanical strength to be achieved at low cost.

b) **Hydraulic limes and cement:** These binding agents used in proportions of 4 to 10% result in very good characteristics being displayed in sandy soils. Their natural hydraulicity obviates the need to add pozzolanic products. The material obtained after cement stabilization has in the end little in common with the earth originally treated. The addition of secondary products such as sodium, sodium sulphate, sodium metasilicate, can in certain soils improve further on the cement treatment. On the other hand the presence in the soil of organic matter or of sulphates will prevent some cements from working properly.

c) **Lignosulphates:** These by-products of the paper pulp industry also act as binding agents. In some areas they are cheaper than cement, but are nevertheless effective at concentrations of 1 to 2%. They have the disadvantage of losing their strength when exposed to water. They can, however, be fixed by adding salts (chromo-lignine).

d) **Sodium silicate:** Used in conjunction with a reagent in modern injection techniques, sodium silicate - under the effect of the reagent - forms a gel which gives certain clay soils additional cohesion.

e) **Bitumen:** Preferably used in fluidized form, the various kinds of bitumen, which is essentially water repellent for clay soils, act as a binding agent when used on sandy soils.

f) **Resins:** Resins of vegetable origin, apart from being water repellent, also act as binding agents. Synthetic resins can also make excellent binding agents when used in compound forms. But these products are often expensive and have to be used at concentrations almost as high as those of cement.

4) Some conclusions

For clayey materials, physico-chemical stabilization will essentially result in water resistance and can be achieved thanks to a very varied



FIGURE 266:
COMPACTION METHOD:
STATIC COMPACTION,
DYNAMIC COMPACTION.



range of water-repellents, often of vegetable origin and including some which are probably not recognised as such. Feasibility studies for earth construction should in our view be undertaken on a regional basis and include a complete survey of the natural resources and by-products of the local economy. This should often lead to the discovery of efficient stabilizers which are cheap and locally produced.

Binding agents have to be used to improve the mechanical qualities of sandy materials. The same could be true of clay soils if exceptional mechanical characteristics are sought. The binding agents which can be used are cement, lime, different kinds of bitumen and possibly of resin. However, local binding agents can in this context also - although less commonly in our opinion than for water repellents - emerge during a preliminary study.

Finally there are a number of incompatibilities which prevent the use on certain clay soils of stabilizers which may be effective on others. This is why there is no universal stabilizer.

In practice and bearing the above in mind, the resolution of a stabilization problem should result in objective reasons leading to the choice of a given product and to the definition of the

FIGURE 267: THE BEHAVIOUR OF VARIOUS MIXES — JUST AFTER REMOVING MOULD (COHESION) AND AFTER A FEW YEARS' EXPOSURE (RESISTANCE TO UNFAVOURABLE CONDITIONS — WATER, FROST, DROUGHT)

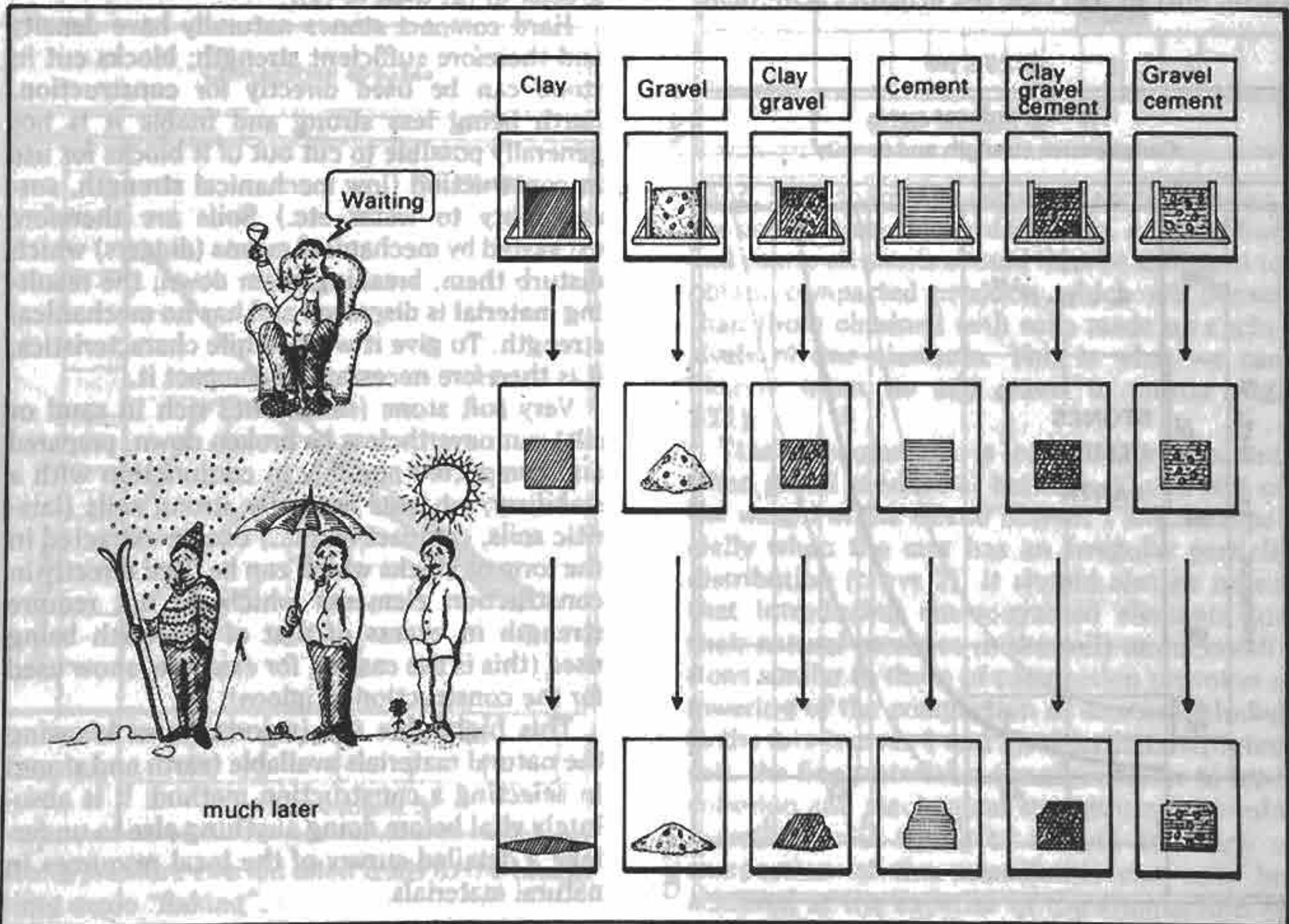

way in which it will be used. The product should be effective, available, compatible with the soil to be treated, the work it is intended to carry out, site conditions and the means at one's disposal in terms of equipment and manpower.

The process should take account of four groups of factors;

- soil type and composition;
- the proportions of soil, stabilizer and water;
- the moulding method envisaged: pouring, pounding, vibration, blows or static pressure;
- physical conditions such as: length and temperature of drying time, time required in the mould etc.

Stabilization in practice

I. Improvement through increased density

A very clear relationship between dry density and mechanical strength can be observed in all materials. The more compact the material, the higher its mechanical strength. Hence, given the same composition and the same dosage, the more dense a cement is, the stronger it will be. Similarly, the densest stones have the highest mechanical resistance. The same applies to earth, only in this case the densities achievable

remain relatively low. Figure 268 shows qualitatively the change in the compressive strength σ' in relation to the specific dry weight γd for these three families of materials. An analysis of the curves shows the benefit to be gained from an increase of γd , particularly for the higher density values, since for the same increase in $\Delta\gamma$, the increase in strength $\Delta\sigma'$ is much greater in (2) than in (1).

Hard compact stones naturally have density and therefore sufficient strength; blocks cut in stone can be used directly for construction. Earth being less strong and friable it is not generally possible to cut out of it blocks for use in construction (low mechanical strength, susceptibility to water etc.) Soils are therefore excavated by mechanical means (diggers) which disturb them, breaking them down; the resulting material is dispersed and has no mechanical strength. To give it worth-while characteristics, it is therefore necessary to compact it.

Very soft stone (sandstones rich in sand or silt) can nevertheless be broken down, prepared and compacted possibly in conjunction with a stabilizer; whereas naturally strong soils (lateritic soils, compact clays...) can be extracted in the form of blocks which can be used directly in construction elements which do not require strength in excess of that of the earth being used (this is the case of, for example, snow used for the construction of igloos).

This highlights the importance of knowing the natural materials available (earth and stone) in selecting a construction method: it is absolutely vital before doing anything else to undertake a detailed survey of the local resources in natural materials.

FIGURE 268

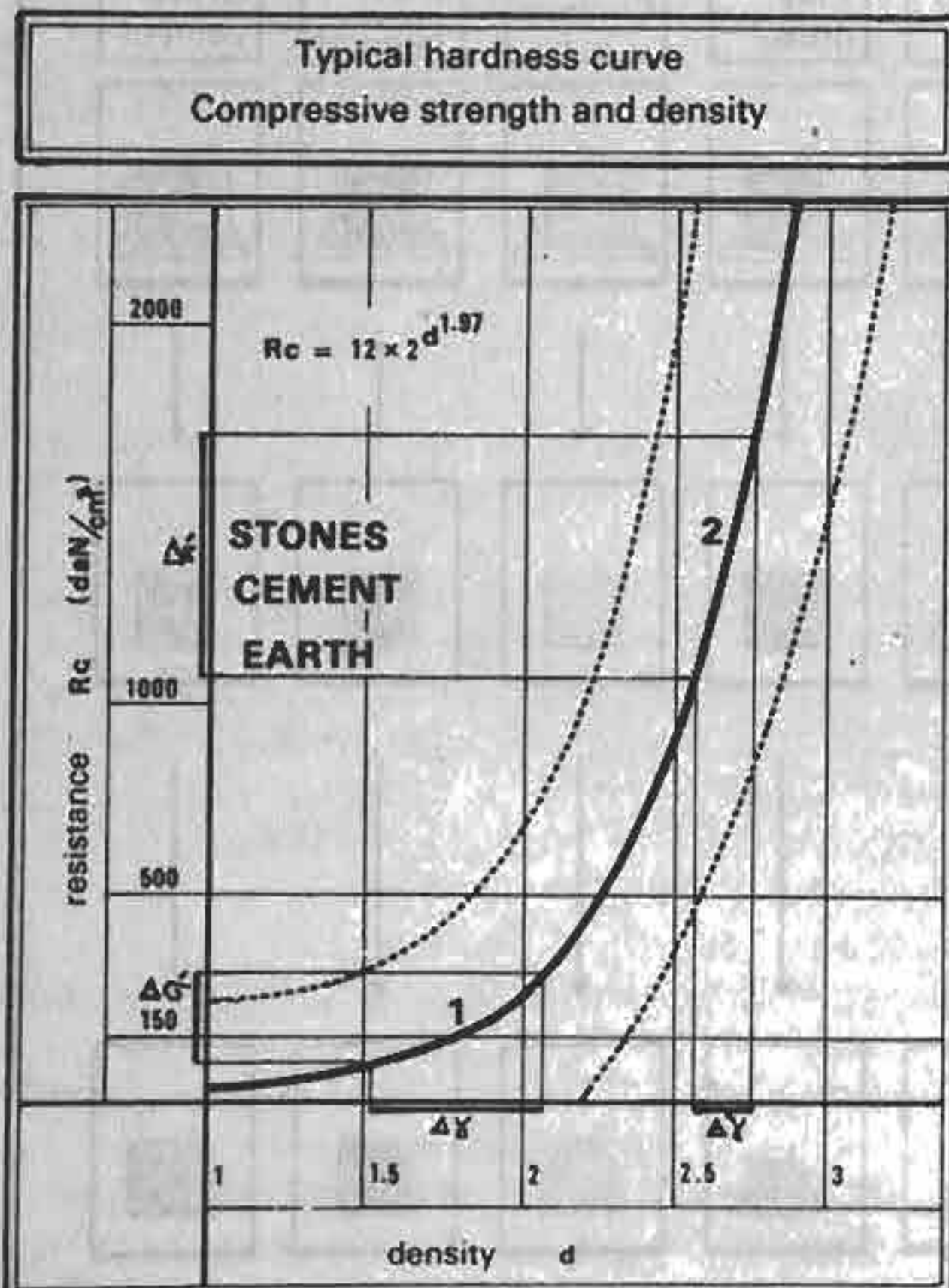

As far as earth construction is concerned, in general this uses processed earth which will require compacting. The quality of compaction achieved will largely determine the properties of the material obtained, regardless of whether a stabilizer is used or not. The suitability for compaction of a soil is usually evaluated by the Proctor test. This test was reviewed in the chapter on "Soil analysis" and is defined as follows: for any given compaction force there exists an Optimal Water Content (O.W.C.) which enables one to achieve maximum dry density.

1) Compaction parameters

a) COMPACTING FORCE

Whatever the type of earth and the method of compaction, a greater compaction force reduces the Optimum Water Content and leads to a greater dry density, as shown by the classic compaction curves (fig. 269).

On the other hand, if the compaction force is too strong it can result in side-effects which have a negative effect on the quality of the material. Thus when using a press, the very

Compaction stresses

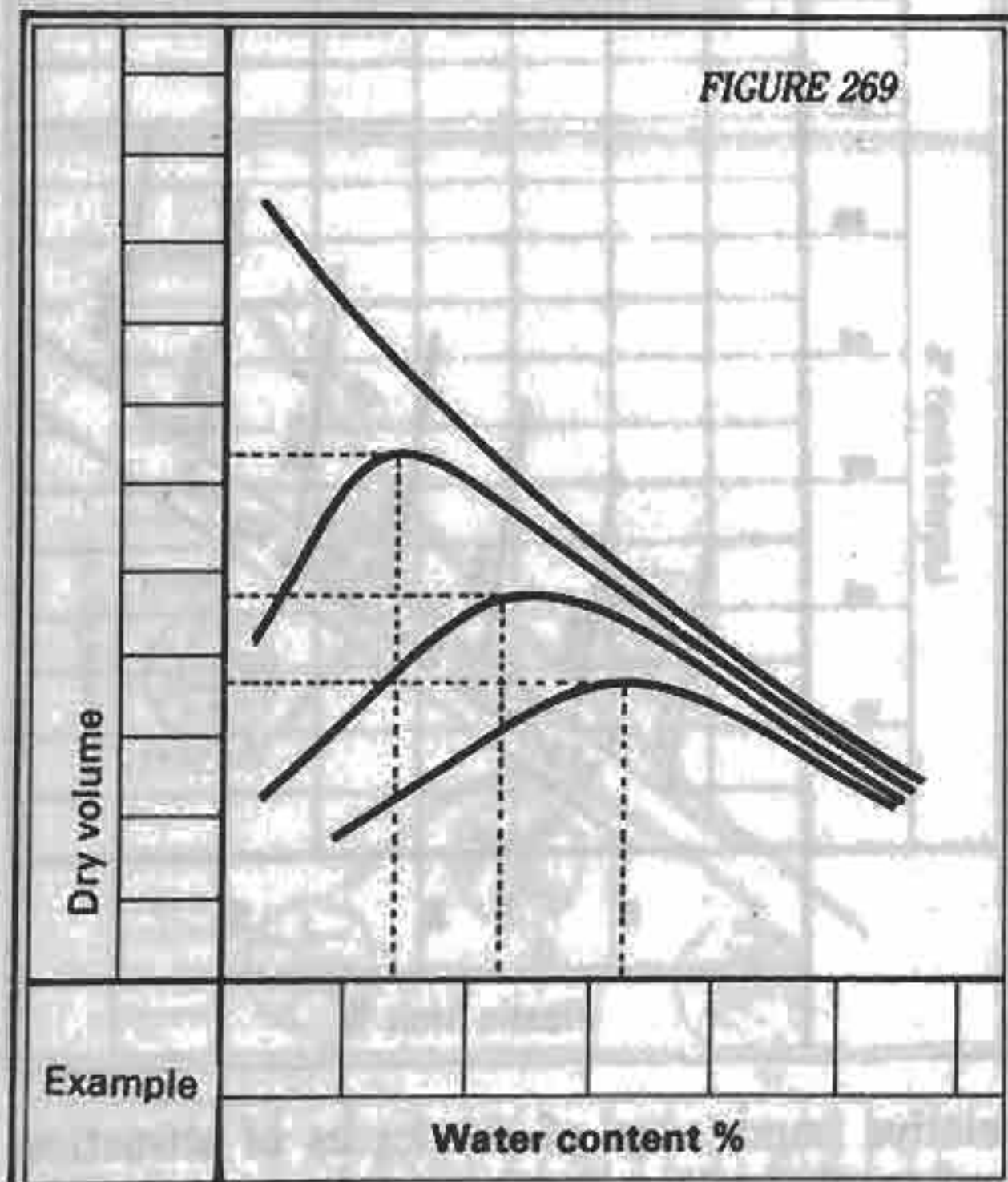

strong pressure exerted often leads to the blocks being made "flaking".

b) SOIL COMPOSITION

A narrow distribution of particle sizes prevents great compactness from being achieved: the compaction curve flattens out after a relatively small peak (fig. 270). Broader distribution curves, which characterize materials with widely differing particle sizes, on the other

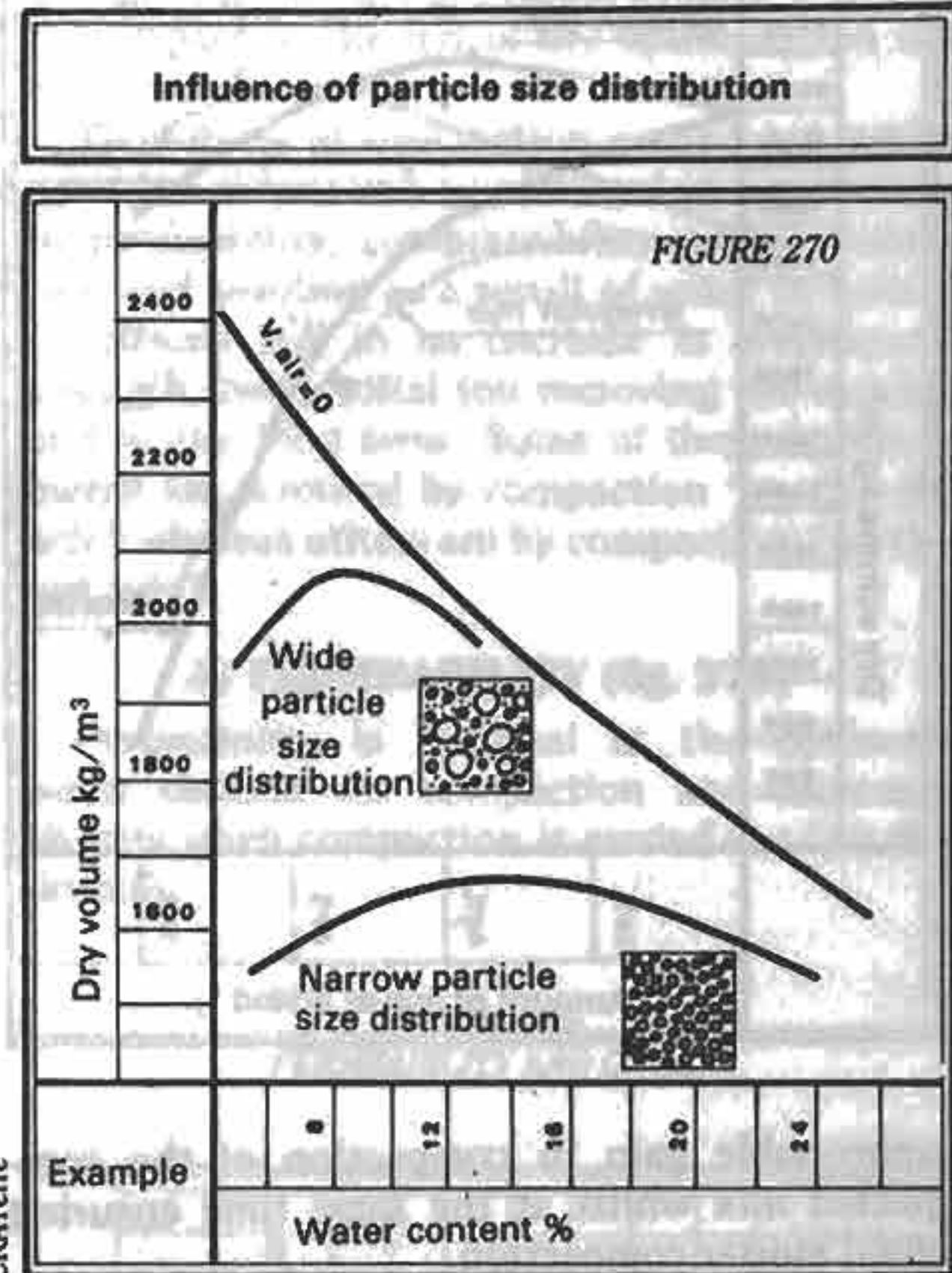

hand, have sharply peaking compaction curves: the compaction obtained is better. A mix of fine and coarse elements should thus be sufficient to obtain compacted products which are denser than those obtained with soils made up exclusively of fine elements. This is what we can observe when we add gravel to mortar (fig. 271).

This phenomenon is particularly apparent when gravel is added at between 30 and 50% of the weight of the mortar (curves 1 and 2), especially when the mix has an irregular particle distribution (curve 2). It should also be noted that introducing coarse-grained elements (or their natural presence in the soil) under conditions similar to those of compaction provokes a lowering of the compaction of mortar included in the mix (curves 1 and 2), since in compacted soil, the fine material is the main factor to lend cohesion and mechanical strength; one should therefore avoid trying to achieve too high a compaction of the mix if this can only be achieved at the expense of the compaction of

the mortar. Figure 271 shows the advantage of a mortar which contains between 20 and 30 % of coarse-grained elements. This mix results in an

FIGURE 271: COMPACTIVITY OF A MORTAR-GRAVEL MIX

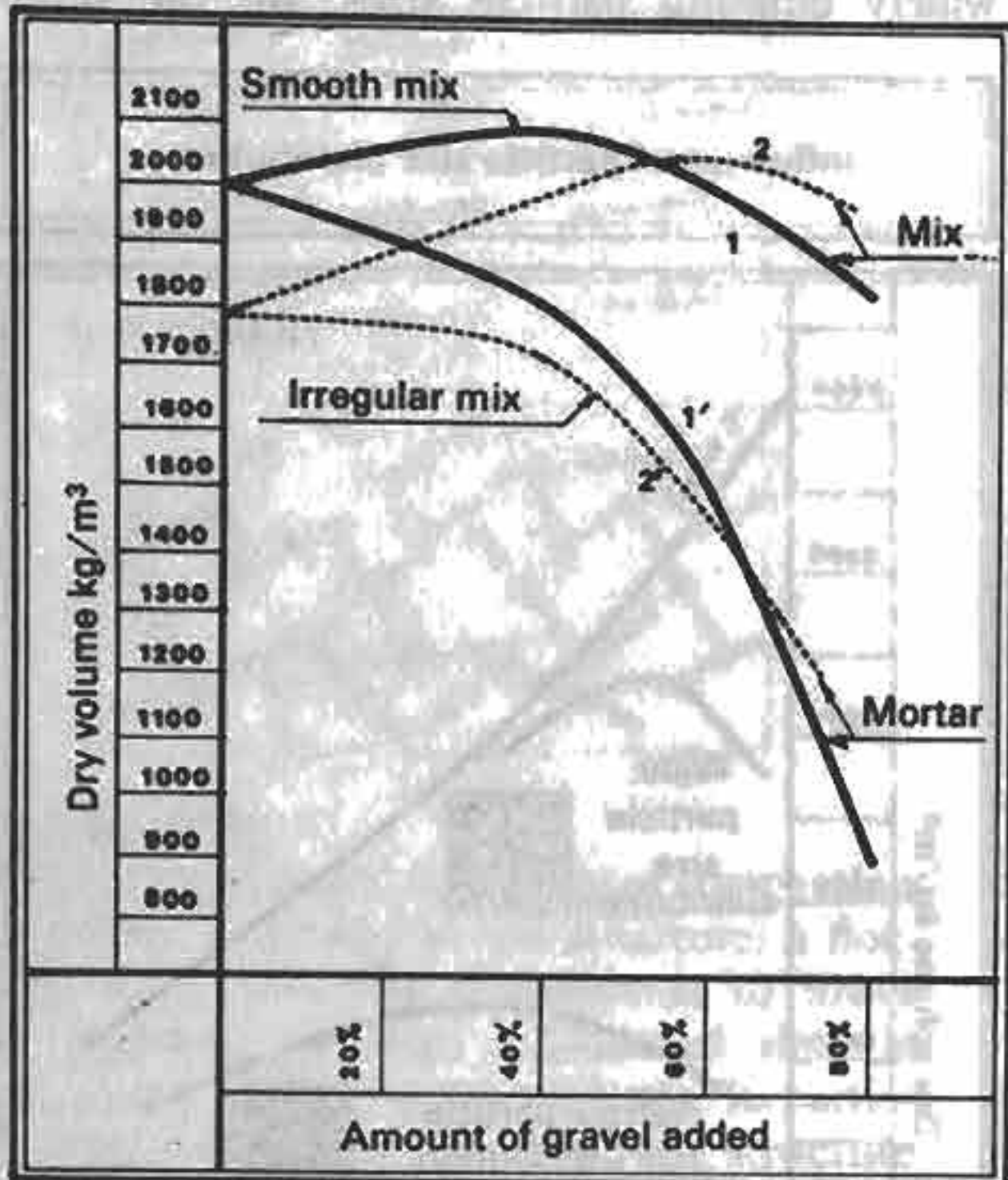

CRATerre

appreciable gain in compaction of the compacted mix whilst at the same time ensuring good mortar compaction.

C) ATTERBERG LIMITS

There is a correlation between the Atterberg limits on the one hand and the dry density and Optimum Water Content (O.W.C.) of the Proctor test on the other. The empirical charts (figs, 272 and 273) give examples of this relationship. The O.W.C., always less than the plastic limit, increases with it and with the liquid limit; at the same time, the dry volume diminishes.

2) Effects of compaction

The main effect of compaction is to tighten up the soil particles which results in:

- an increase in the number of points of contact between soil particles;
- a reduction in the proportion of spaces, that is in the porosity of the soil.

For clay soils, the small size of the particles and their wide specific surface area make them behave in a particular way: depending on the

FIGURE 272: ATTERBERG LIMITS AND O.W.C.

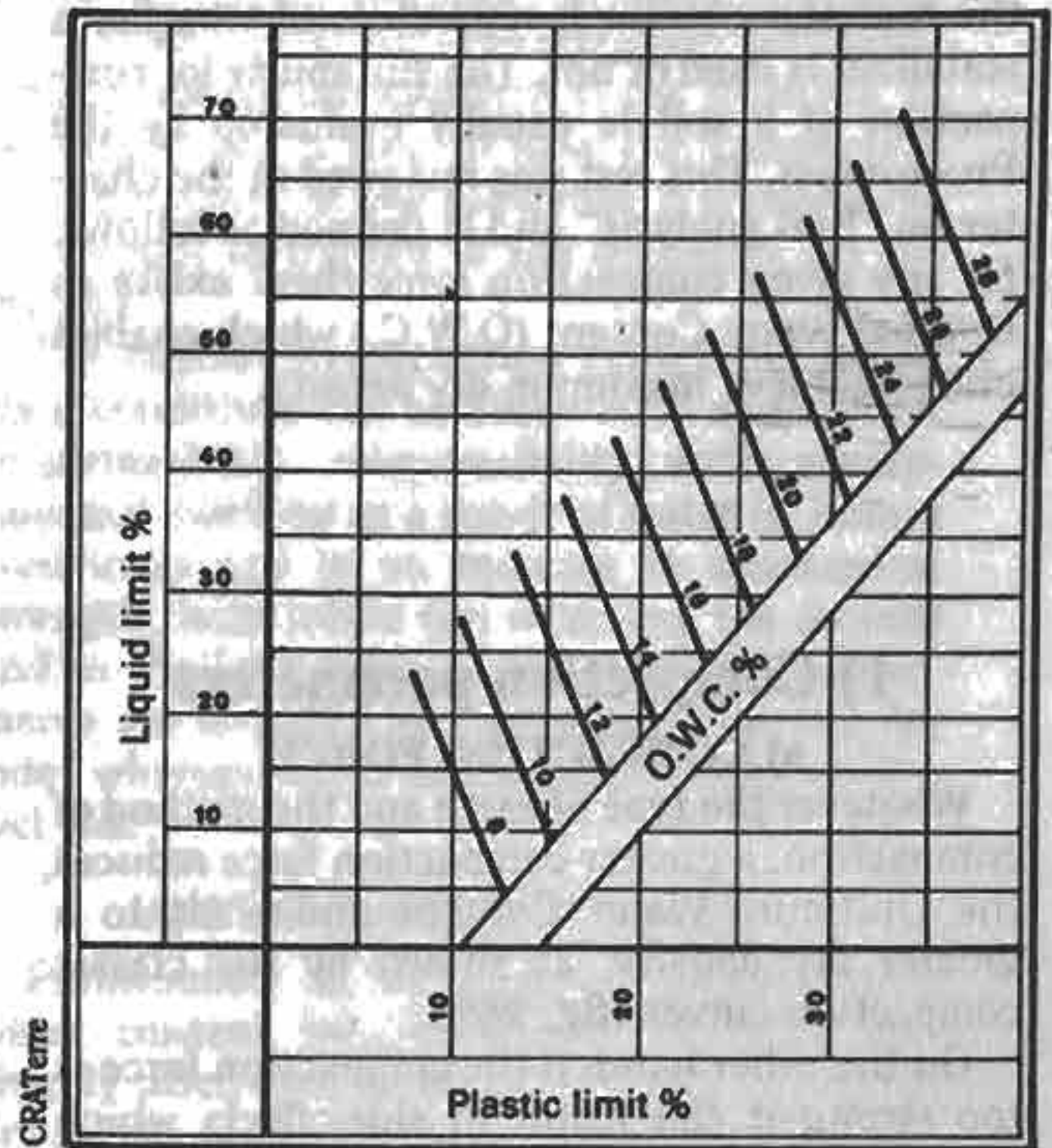

CRATerre

FIGURE 273: ATTERBERG LIMITS AND DENSITY

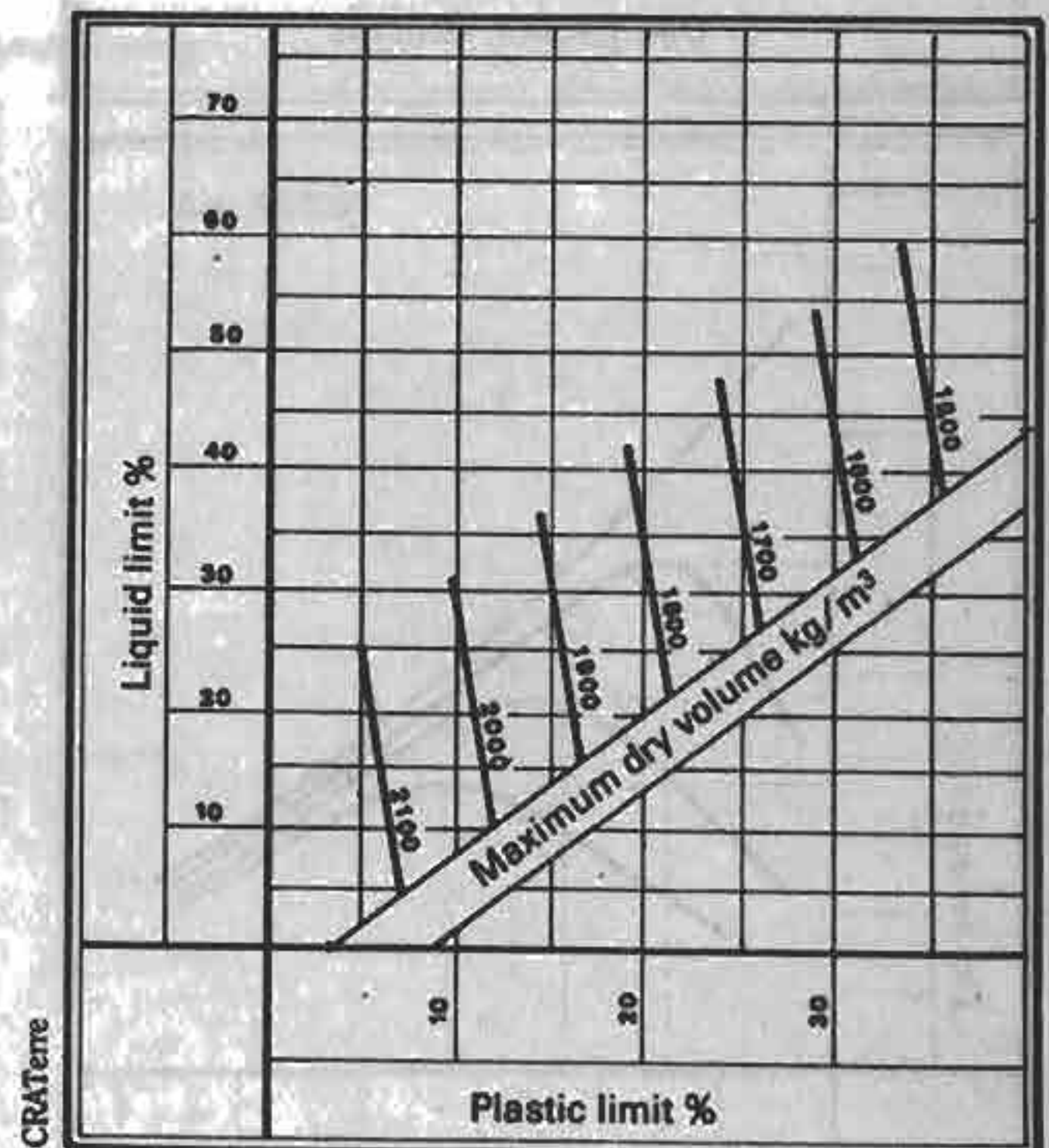

CRATerre

relative importance of the forces of attraction and repulsion, two fundamental types of structure can be observed:

- a dispersed structure indicating predomi-

nantly repulsive forces: the clay plates which are separated one from the other tend to be parallel to each other;

- a flocculated structure indicating predominantly attractive forces: the clay plates draw together and form sharp angles between them-

FIGURE 274: TOPS, DISPERSED STRUCTURE:
BOTTOM, FLOCCULATED STRUCTURE

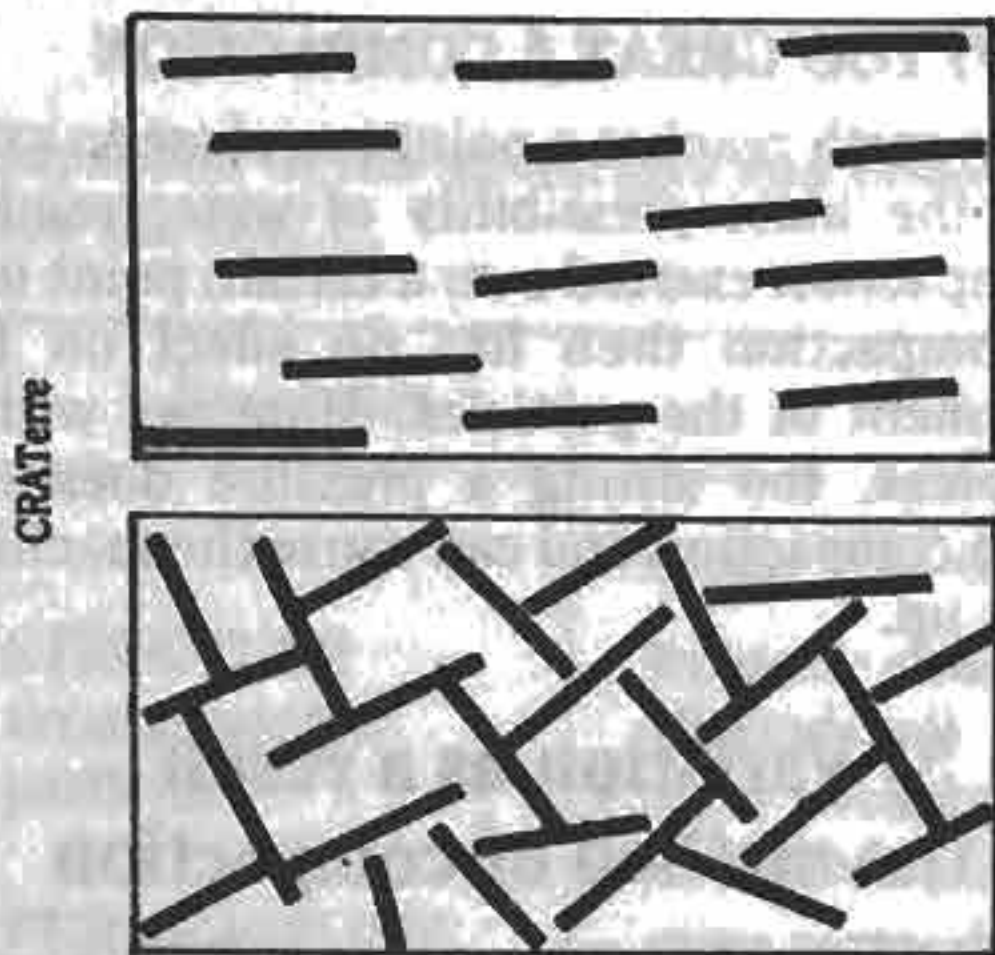

selves (fig. 274).

In these conditions, the effects of compaction differ widely according to the structure: a flocculated state generally corresponds to lower water contents, whereas a dispersed state is characteristic of high water contents. In particular along the compaction curve the structure could be more dispersed to the right of the optimum and more flocculated to the left (fig.

FIGURE 275: STRUCTURE

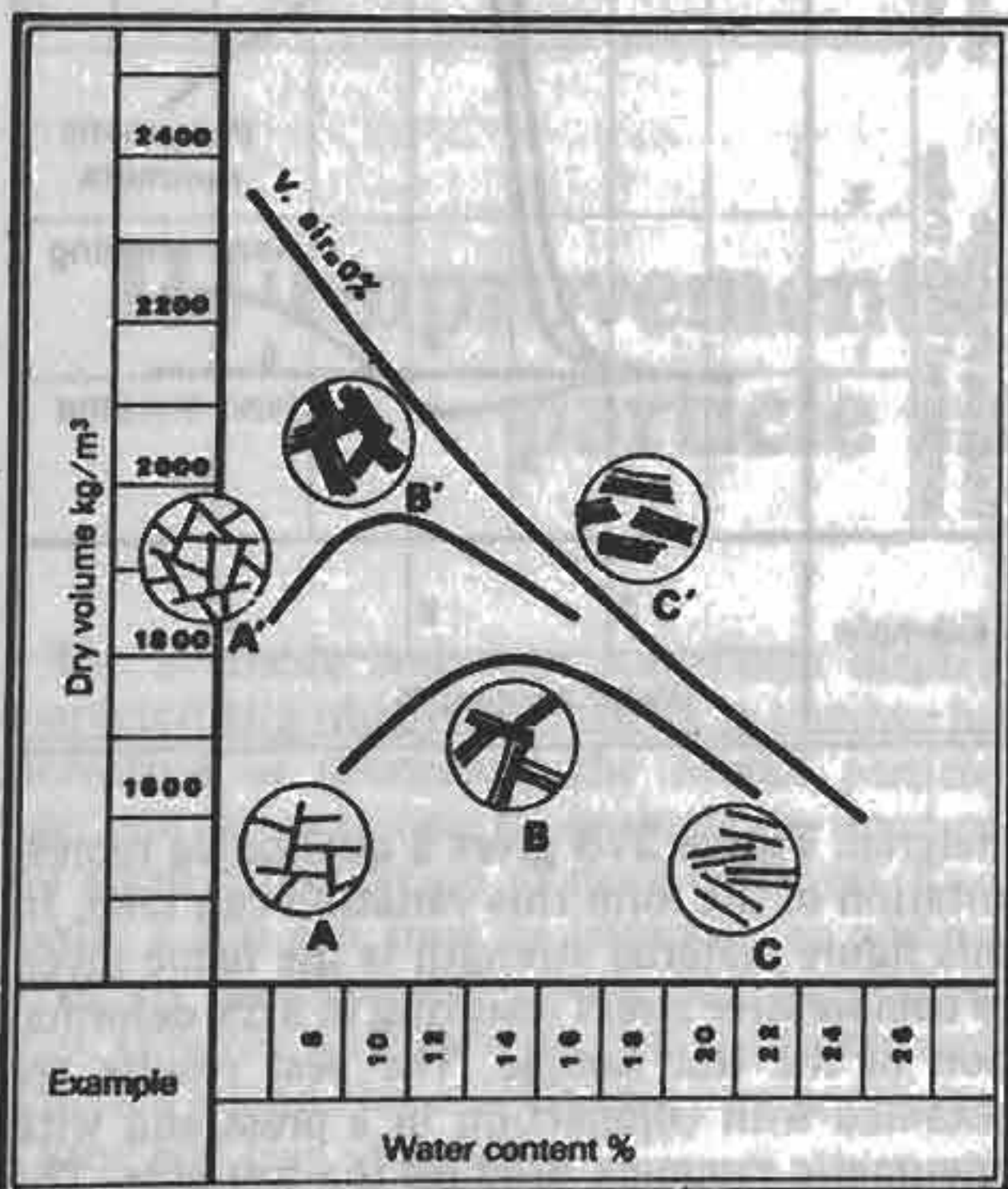

275). In A, the particles come together and tend to flocculate; as the water content increases they disperse and adopt more regular patterns (B and C). The optimum compaction thus appears to be at a state when the forces of attraction remain sufficient to allow good compaction whilst the forces of repulsion facilitate a certain ordered arrangement of the particles. In practice if one is sure to have the compaction energy required at one's disposal, it is preferable to compact to the left of the optimum, on the dry side.

The effects of compaction carried out under good conditions can be observed in a reduction in permeability, compressibility, water absorption and swelling as a result of water in humid conditions and in an increase in mechanical strength, both initial (on removing the mould) and in the long term. Some of these improvements are favoured by compaction "on the dry side" whereas others are by compaction "on the wet side".

A) PERMEABILITY (fig. 276)

Permeability is minimal at the optimum water content for compaction and increases sharply when compaction is carried out "on the dry side".

FIGURE 276:
PERMEABILITY AND O.W.C.

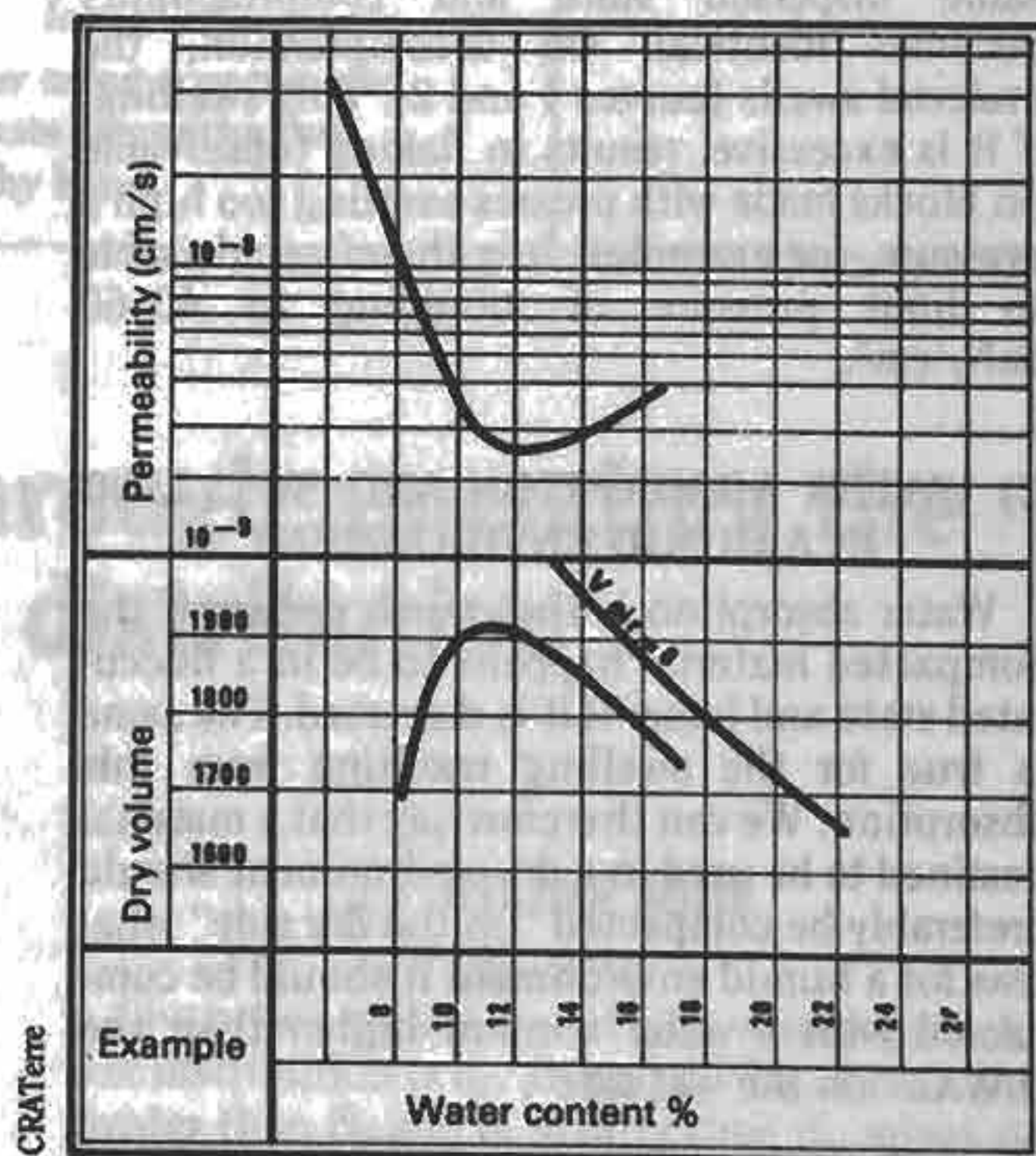

B) COMPRESSIBILITY (fig. 277)

So long as the stress exerted does not exceed a certain value, a material with a flocculated

FIGURE 277: COMPRESSION — DECOMPRESSION

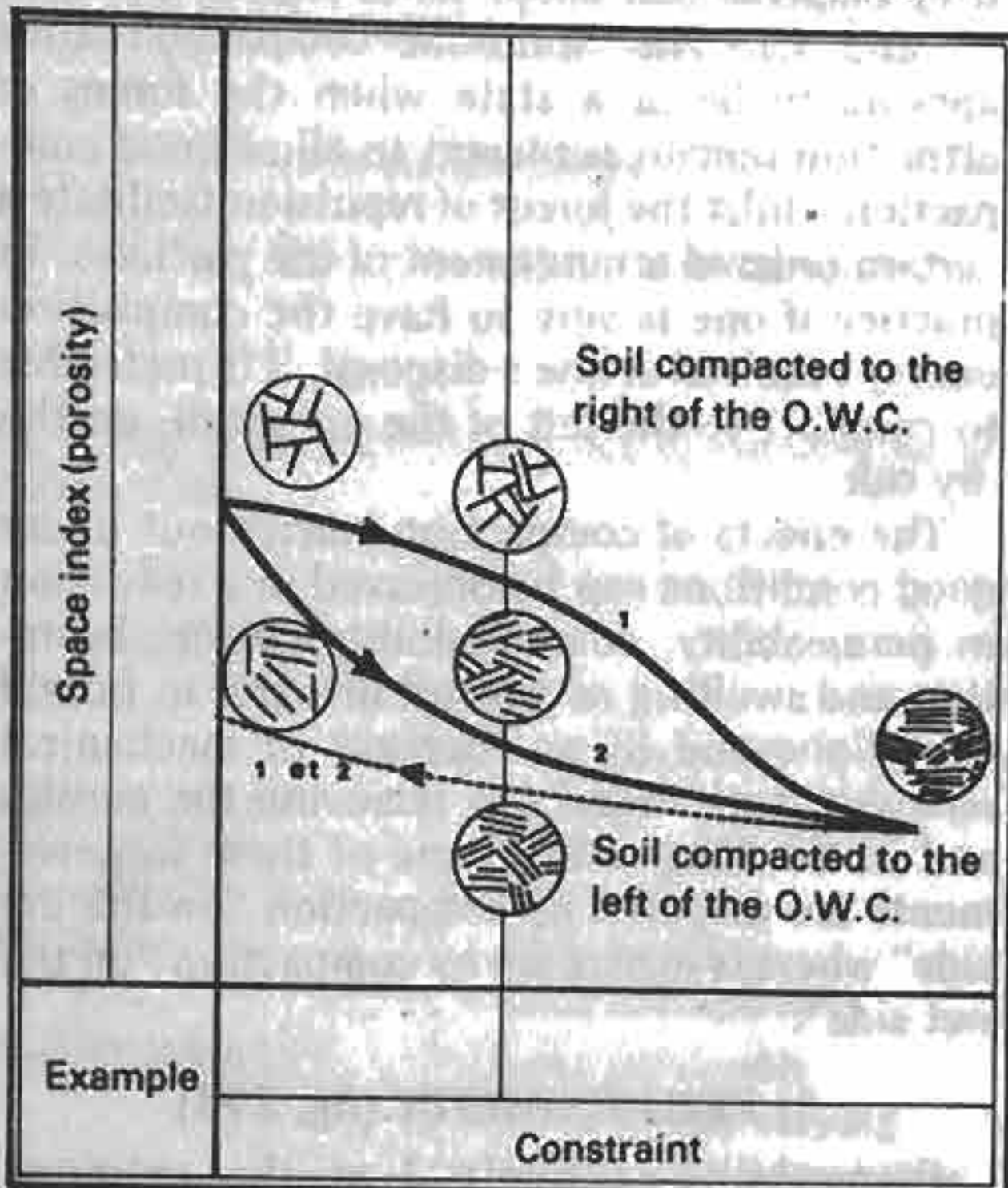

structure is a great deal less compressible (curve 1) than a material of the same kind and of the same initial compactivity with a dispersed structure (curve 2). If the pressure becomes sufficiently high to allow the rearrangement of the particles, the two materials tend towards the same dispersed state and compressibility becomes identical. On decompression, the material swells (curves 1 and 2). This swelling, if it is excessive, results in flaking (observable on blocks made with presses exerting too high a pressure, for example). It is therefore advisable to limit pressure of moulding to 40-60 daN/cm².

C) WATER ABSORPTION AND SWELLING IN A HUMID ENVIRONMENT

Water absorption is that much greater if the compacted material happens to be in a flocculated state and lesser if it is dispersed. The same is true for the swelling resulting from this absorption. We can therefore say that a material destined to be used in a dry environment should preferably be compacted "on the dry side" whereas for a humid environment it should be compacted with a water content higher than the O.W.C. "on the wet side".

D) INITIAL MECHANICAL STRENGTH

Initial strength, just after compaction, determines the rapidity of the removal of the moulds and the handling of the blocks; it is

therefore an important parameter and is at its maximum for a compaction carried out "on the dry side".

E) LONG-TERM MECHANICAL STRENGTH

This is directly linked to the dry density of the material, which leads to compaction at or close to the O.W.C.

F) TOO GREAT A COMPACTION

When earth reaches a point too close to saturation, the incompressibility of water renders the compaction exerted over a certain point useless: compaction then has no effect on the arrangement of the particles. Moreover with a brick press, too strong a pressure does not improve compaction and can cause the machine to seize up.

3) Variation as a result of the method of compaction

The method of densification used has a considerable influence on the final strength of the

FIGURE 278: STRENGTHS FOR A 5% DEFORMATION OF THE TEST SAMPLE.

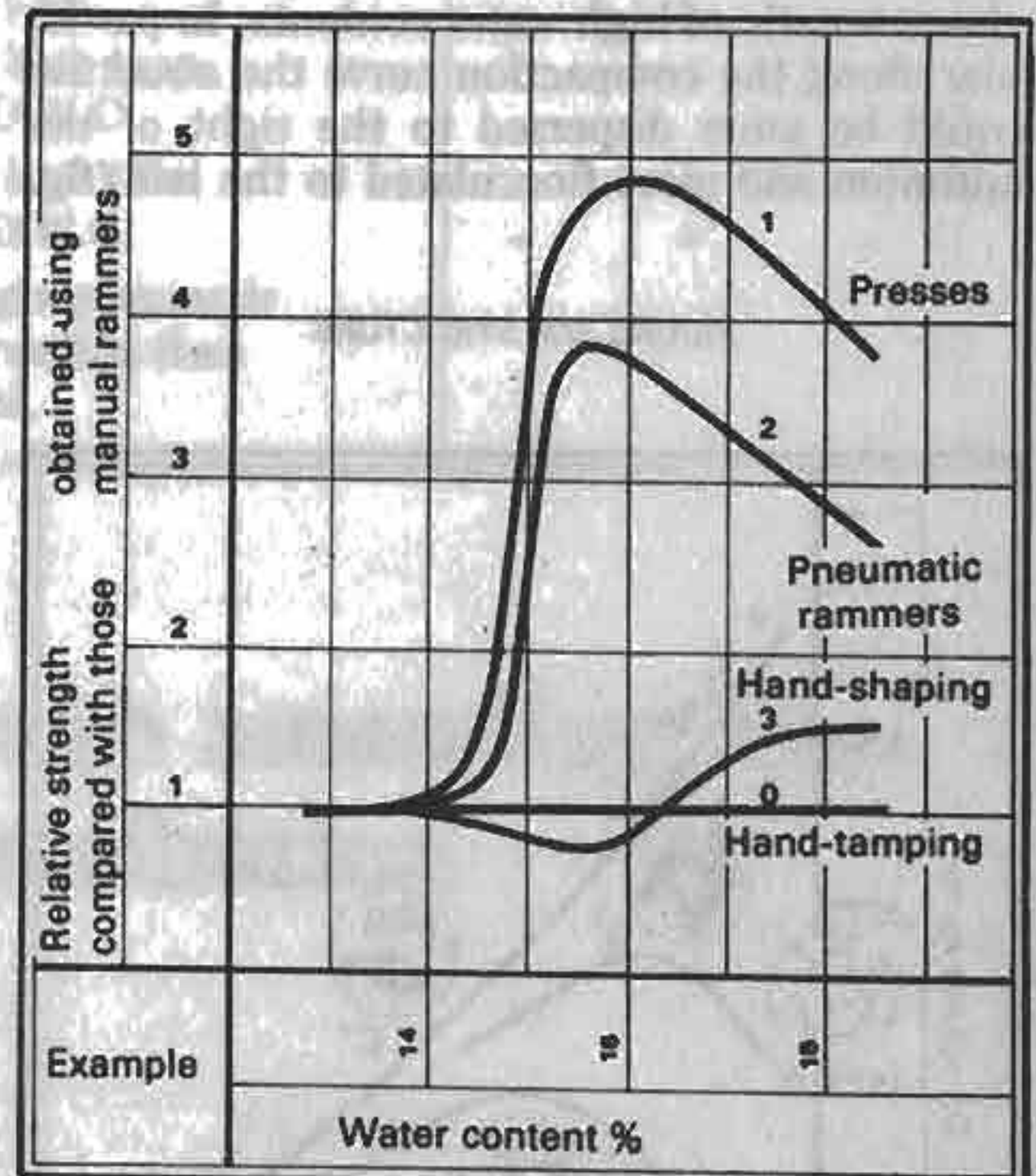

material. Figure 278 gives a qualitative representation of the form this variation can take. In this figure material strength is the name given to compressive stress resulting in a 5% deformation of the test sample. The best results are obtained with compaction in a press and with pneumatic rammers used on the wet side. The

strengths obtained can be 3 to 5 times higher than those obtained with hand rammers.

4) Conclusions

Compaction plays an essential part in ensur-

ing the success of any stabilization method and indeed can on its own often solve a stabilization problem. At the same time it must be remembered that the improvements obtained by compaction are eliminated for the most part in damp conditions (immersion).

Comparison of the advantages and disadvantages of compaction carried out at a water content above or below the O.W.C.

Properties	Comments		Evaluation		
	Dry side W.C. < O.W.C.	Wet side W.C. > O.W.C.	dry	O.W.C.	wet
STRUCTURE arrangement of particles	- irregular structure (flocculated)	- regular structure (dispersed)	+	+	-
	- more swelling	- less swelling	-	+	+
	- more absorption	- less absorption	-	+	+
PERMEABILITY	- more permeable	less permeable			
	- permeability varying greatly with compactity	- permeability varying little with compactity	-	+	+
COMPRESSIBILITY	- more compressible with high pressures	- more compressible with low pressures	+	+	-
STRENGTH - immediately after removing mould - ultimately	- higher - less high than for O.W.C.	- less high - less high than for O.W.C.	+	-	-
DENSITY	- less high than for O.W.C.	- less high than for O.W.C.	-	+	-
METHOD OF COMPACTION	- compaction with a press or using a pneumatic rammer gives better ultimate strengths than Proctor-type compaction by hand.		-	+	-

II) Improvements through amending the particle size distribution

The available soils can sometimes display characteristics which it is possible to improve by increasing or decreasing the overall particle size; one can overcome for example too great or too small a proportion of fines or gravel. Too plastic a soil can thus be improved by adding sand; an insufficiently plastic soil by adding fines. (See the variations in plasticity (Atterberg limits) of a sand-clay mix for various proportions of sand and clay - fig. 256).

1) Mixing soils

(fig. 279)

Given two soils (1) and (2), whose particle size distribution is d_1/D_1 and d_2/D_2 where D_1 is greater than D_2 and d_1 greater than d_2 , mixes of these two soils will have a particle size distribution of d_2/D_1 and their curves will lie "between" curves (1) and (2).

The curve of a mix made up of m% of (1) and 199

FIGURE 279: FINDING THE CURVE OF TWO MIXED SOILS; —
CONTINUOUS LINES: THE TWO ORIGINAL SOILS;
DOTTED LINES: MIXES

CLASSIFICATION

DECIMAL	Stones		Gravel		Coarse sand			Fine sand		Silt	Clay
U S B R	Stones	Gravel		Sand			Limons (Silt)		Clay		
		coarse	fine	coarse	medium	fine					

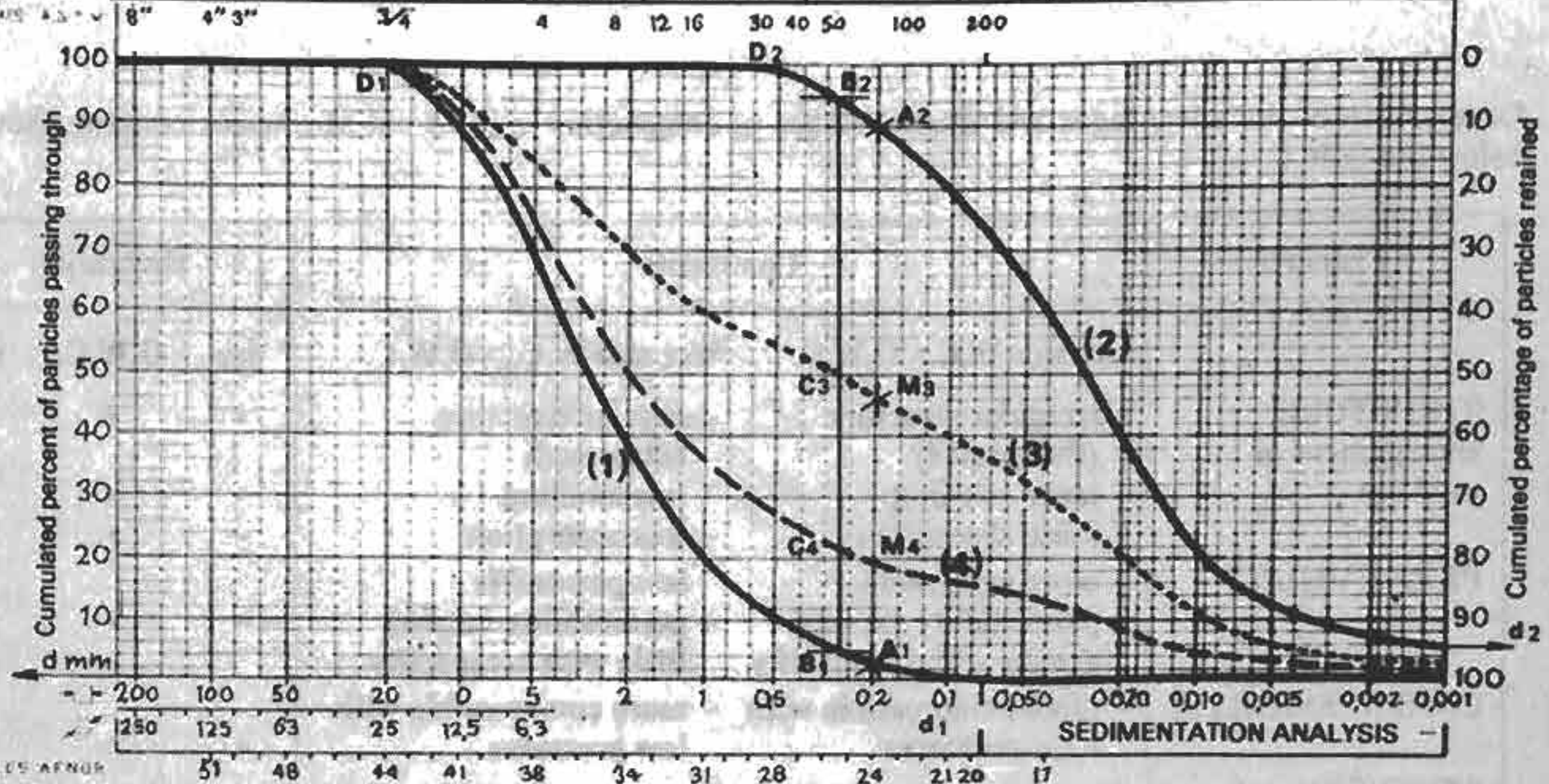

- (3) Mix made up of 50% of (1) and 50% of (2)
- (4) mix made up of 80% of (1) and 20% of (2)

n% of (2) will be such that:

$$\frac{MA_2}{MA_1} = \frac{m}{n}$$

For a given particle size, M is located on the curve of the mix A₂ on the (2) curve and A₁ on the (1) curve. The values of MA₂ and MA₁ can be read as percentages on the ordinate scale.

Thus for example for a size of 2 mm and mix curve (4) we can see:

$$\frac{M_4 A_2}{M_4 A_1} = \frac{70.4}{17.6} = \frac{m}{20} = \frac{80}{20}$$

This applies to all particle sizes between D₁ and d₂.

A mix (4) made up of 80% of soil (1) and 20% of soil (2) does contain 19.6% of elements smaller than 0.2 mm. Thus 100 kg of this mix would contain 80 kg of soil (1), that is 0.02 × 80 = 1.6 kg of elements smaller than 0.2 mm, and 20 kg of soil (2), that is 0.9 × 20 = 18 kg of elements smaller than 0.02 mm.

Note: A perpendicular line between B₁ [5% point on curve (1)] and B₂ [95% point on curve (2)] cuts the mix curve at C, the percentage value of which read off the ordinate is very close to n%: 22% for mix (4) made up of 80% of soil (1) and 20% of soils (2) - 50% for mix (3).

2) Optimum particle size distribution mixes

The optimum particle size distribution curves of soils for specific uses are located within certain limits. When the curve of a soil is not partly or totally within these limits it possible to mix it with another which has a high content of the elements in which it is deficient in order to obtain a satisfactory product. Figure 280 shows a few examples of this procedure.

a) soil with too high a proportion of coarse-grained elements (fig. 280a)

To reduce soil (1) to an acceptable particle size distribution all that is needed is to sieve it to remove the coarser-grained elements. Using a 10 mm mesh is thus enough to produce a soil the particle size distribution curve of which is within the limits (1). 14% of elements greater

FIGURE 280a: FINDING THE PROPORTIONS OF THE MIX REQUIRED TO ATTEMPT TO ACHIEVE, FROM THE STARTING-POINT OF DIFFERENT SOILS, A SOIL FALLING WITHIN THE LIMITS APPROPRIATE FOR RAMMED EARTH.
 - CONTINUOUS LINES: THE TWO ORIGINAL SOILS
 - LIGHT BROKEN LINES: THE LIMITS APPROPRIATE FOR RAMMED EARTH AND THE IDEAL CURVE
 - BOLD DOTTED/BROKEN LINES: THE MIXED SOIL CURVE

CLASSIFICATION

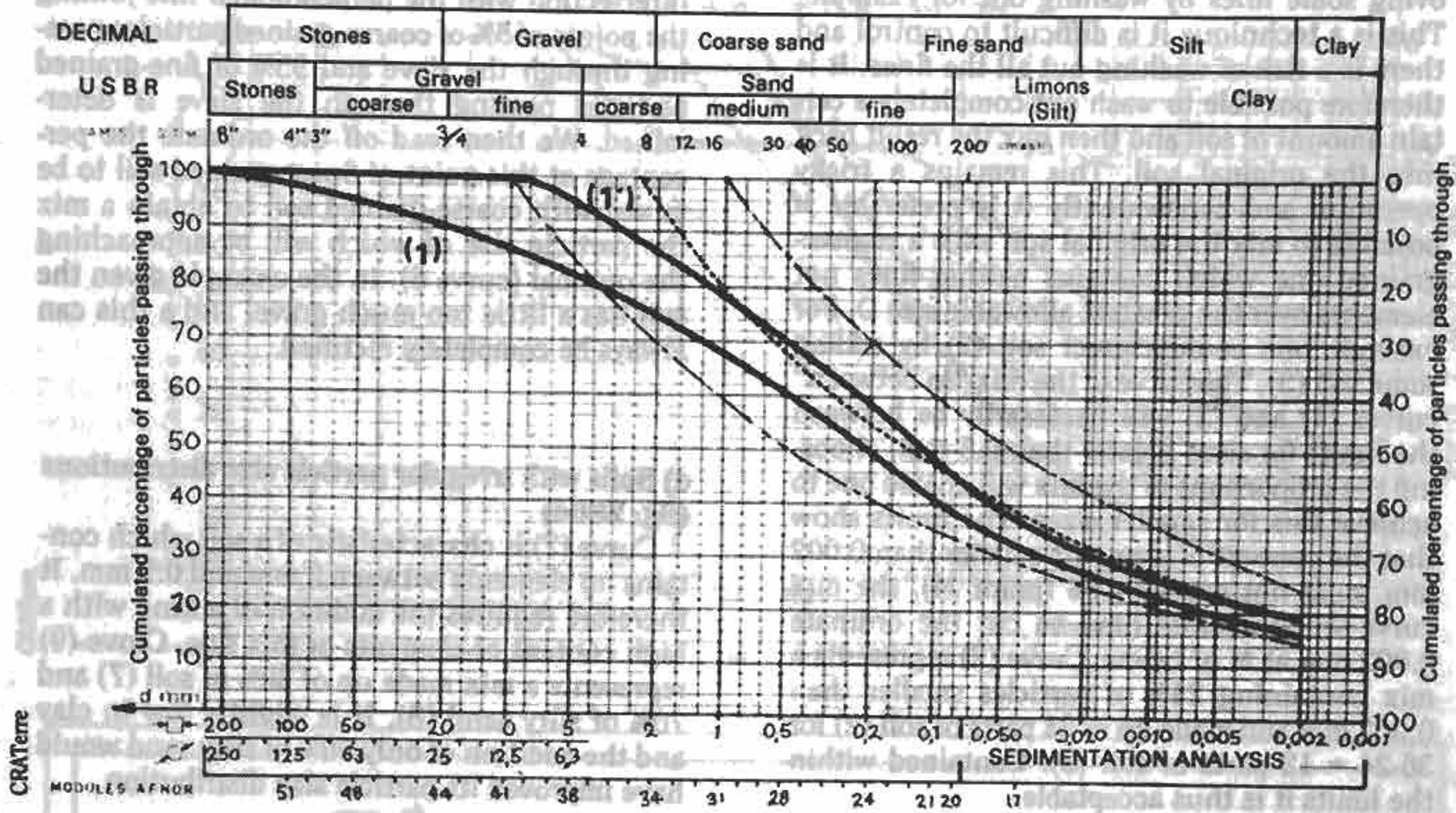

Physico-chemical

FIGURE 280b:

CLASSIFICATION

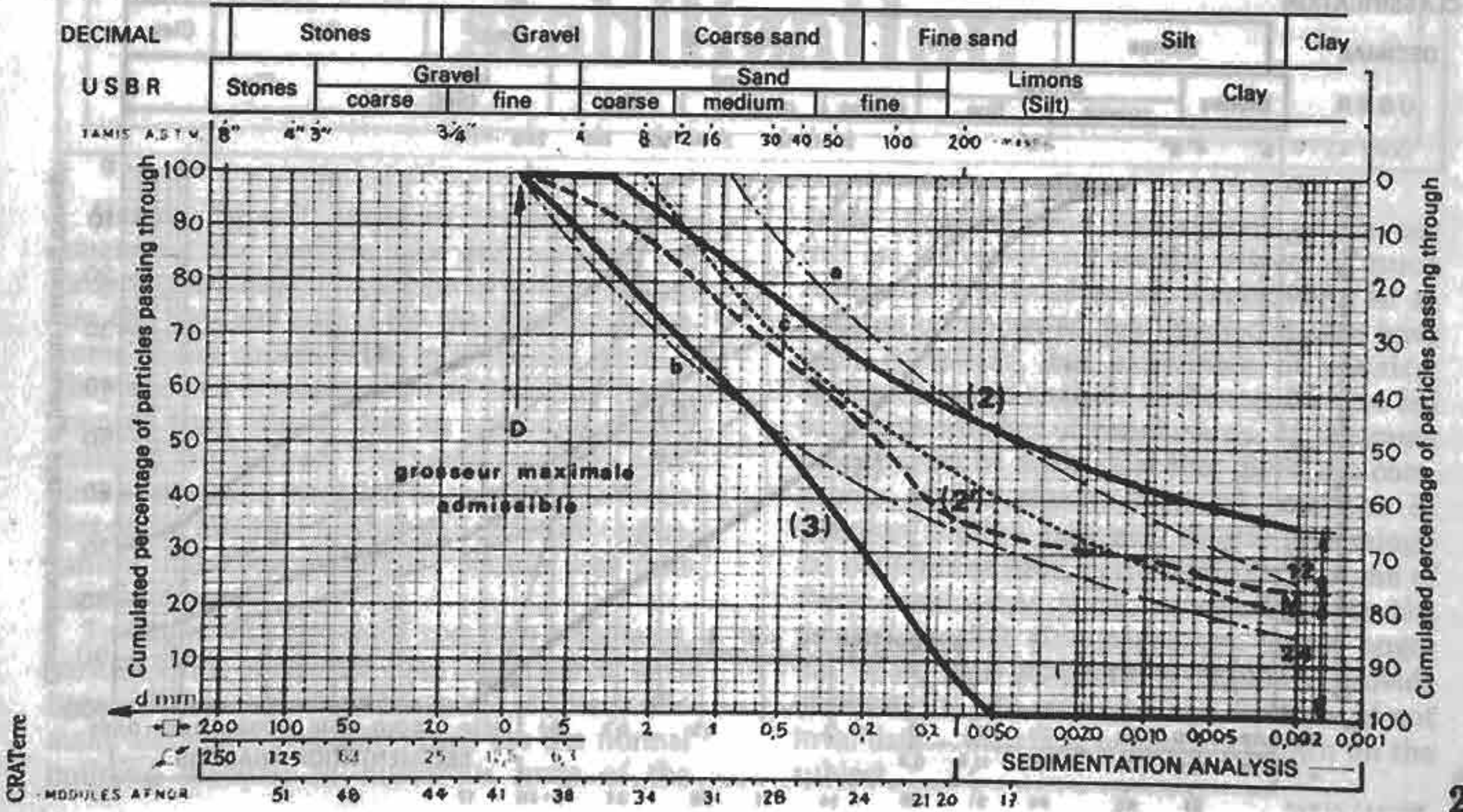

than 10 mm are removed which raises curve 1 by the same amount. Sieving through a 2 mm mesh would give a corrected soil, finer but still within the limits.

b) soil containing too high a proportion of fine-grained elements (fig. 280b)

This type of soil (2) can be improved by removing some fines by washing out for example. This is a technique it is difficult to control and there is a risk of washing out all the fines. It is therefore possible to wash out completely a certain amount of soil and then mix the result back into the original soil. This remains a tricky operation and consequently it is preferable if possible to mix the original soil with a coarser-grained one which contains neither fines nor elements over the greatest allowable size D. For example one could correct soil (2) by adding some soil (3). The curve of the mix "in between" curves (1) and (2) will necessarily be between the limits for sizes greater than 0.5 mm, choosing the proportions of the mix will enable one to achieve this for smaller sizes. The limits show that the content of elements smaller than 0.002 mm must not exceed 24% (point M), the mix curve will therefore have to cut the ordinate 0.002 mm at M or below. Curve (2) represents a mix containing 24% of particles smaller than 0.002 mm and made up of 24 parts of soil (2) for 36-24 = 12 parts of soil (3). Contained within the limits it is thus acceptable.

c) Soils which are too coarse- or too fine-grained and the curves of which fall outside the limits (fig. 280c)

It will be necessary to mix a coarse-grained soil and a fine-grained one. This can be dealt with bearing in mind the remarks made above (Soil mixing). The optimum particle distribution curve (c) is drawn within the limits and its intersection with the perpendicular line joining the points of 5% of coarse-grained particles passing through the sieve and 95% of fine-grained particles passing through the sieve is determined. We then read off the ordinate the percentage at this point of finest-grained soil to be mixed with coarse-grained soil to obtain a mix the particle size of which will be approaching the optimal (curve 6). In the example given the soil has a little too much gravel and a this can always be completely rectified.

d) Soils with irregular particle size distributions (fig. 280d)

Curve (7) is characteristic of a soil which contains no elements between 2 mm and 0.2 mm. It therefore requires the addition of a sand with a high content of elements of this size. Curve (9) represents a mix made up of 30% of soil (7) and 70% of silty sand (8). It is slightly low in clay and the addition of only 60% of silty sand would have improved its particle size distribution.

FIGURE 280c:

CLASSIFICATION

DECIMAL	Stones		Gravel		Coarse sand			Fine sand		Silt	Clay
U S B R	Stones	Gravel		Sand			Limons (Silt)		Clay		
		coarse	fine	coarse	medium	fine					

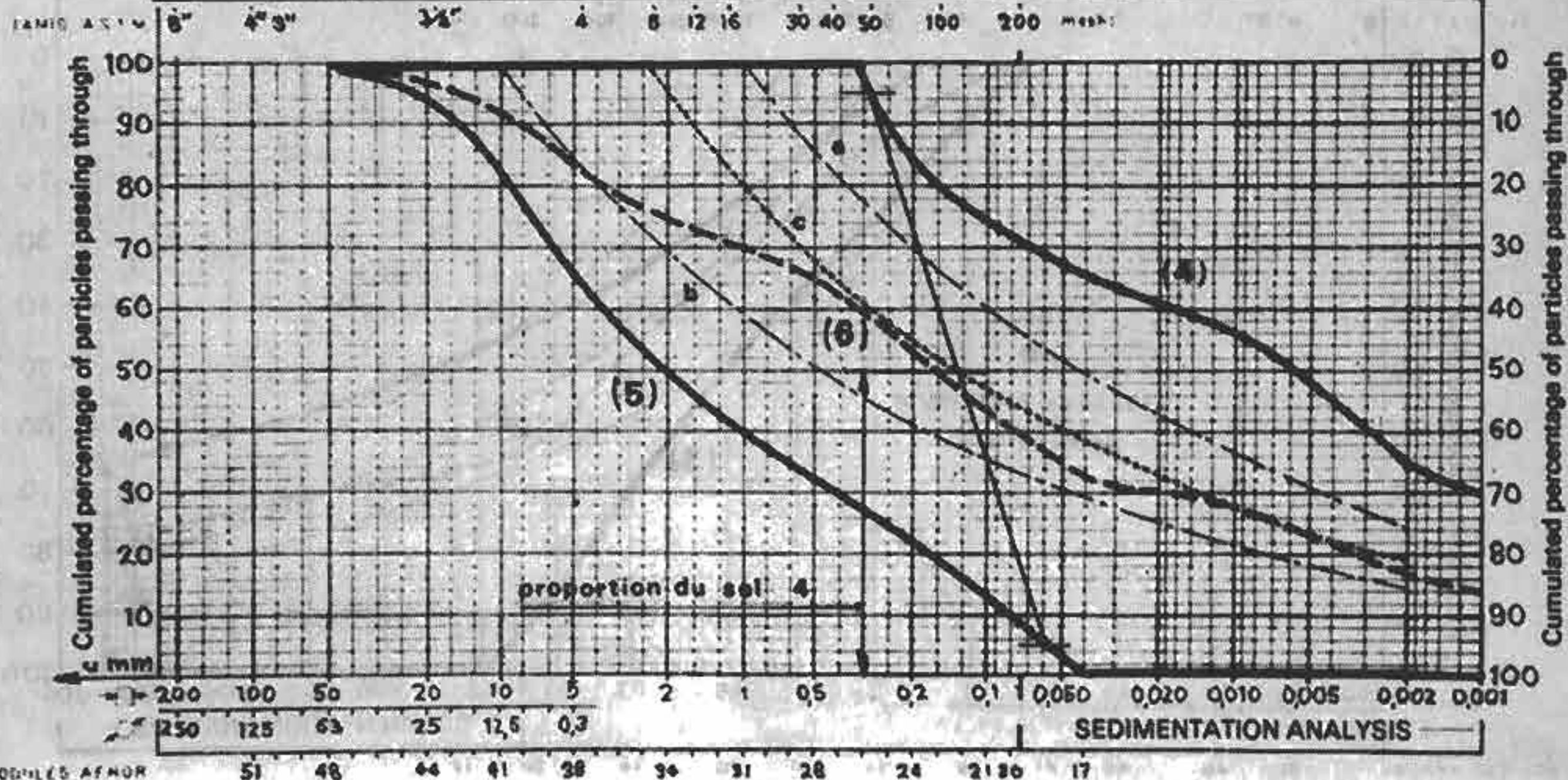
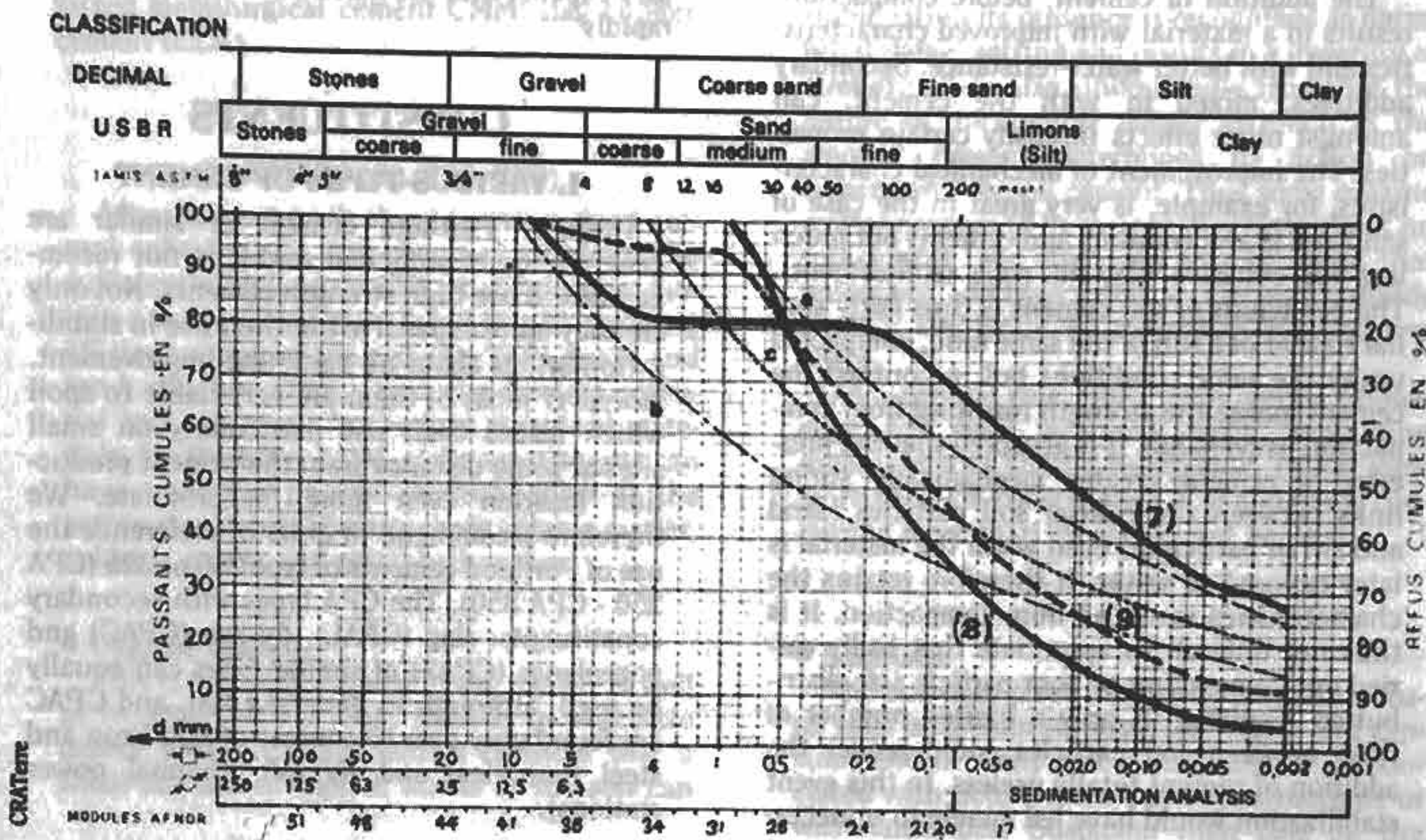

FIGURE 280d:



Physico-chemical stabilization

Having "good" earth or making one by amending the particle mix and carrying out proper moulding (compaction or wet moulding) are the two key points for the successful outcome of any construction in processed earth. If they are well thought out and correctly implemented they ensure that an optimum quality material is obtained. The complementary addition of products intended to enhance the qualities of the material further and above all to guarantee that these properties endure over time can be of benefit.

To begin with the most common stabilizers, various kinds of cement, lime and bitumen have been used since ancient times and enable one to make stabilized products which are the normal building material in numerous parts of the

world. Road-building applications which use this are universal and are the subject of much study and highly advanced research. As far as housing is concerned, few detailed studies have been completed, but experience of practical applications and analysis of the results have led to a large number of conclusions. At the same time it must be made clear that given the complexity of the physico-chemical reactions in question and the extremely diverse mineralogical contents of soils, particularly clays, some of these conclusions must be regarded with the greatest possible circumspection. Indeed ongoing trials and publications regularly provide observations and results which modify - if not invalidate - what was previously known on the subject.

Cement

The addition of cement, before compaction, results in a material with improved characteristics and with better water-resistance. Secondary additives, mixed in with the cement, can amongst other effects intensify certain properties. The improvement of mechanical characteristics, for example, is very great in the case of sand and gravel (mortars and cement) but much less for cohesive clay-silt soils (soil-cement). The behaviour of soil-cement is thus fairly similar to that of a soil of the same kind, compacted under the same conditions but in contrast the cement makes the strength resulting from compaction irreversible. It is accepted that the presence of cement creates mechanically strong links between the coarser soil particles (sand and silt in particular) even when the material is later exposed to water. It therefore retains the characteristics resulting from compaction. It is thus not difficult to appreciate that badly carried out compaction or poor particle size distribution resulting in only a limited number of links between soil particles could render the addition of cement totally useless. In this event stabilization would have led merely to unneces-

sary expense and the material would deteriorate rapidly.

CONSTITUENTS

1. VARIOUS TYPES OF CEMENT

Ordinary Portland cement or similar are generally quite sufficient and it is not recommended to use high strength cements. Not only are they more expensive but their use in stabilization brings about no particular improvement. Moreover most of them are very liable to spoil which makes their use particularly on small sites at some distance from the cement production location even more inappropriate. We therefore recommend in order of preference the use of Portland cements of type 250 or 325 (CPA 250 - CPA 350). The CPA types with secondary constituents: slag (CPAL), fly ash (CPAC) and pozzolanas (CPAZ) of similar types can equally be used, although in general CPAL and CPAC are found only near to sources of slag (iron and steel foundries) and fly ash (thermal power stations).

In accordance with recent standards, only four types of cement are now differentiated: CPA without secondary constituents (up to 35%, which makes it equivalent to the former CPF); CHF and CLK. CMM no longer exists.

As far as stabilization is concerned, the increased content of fine non-active elements (fillers) in the new cement types is noteworthy and is likely to modify the stabilizing effect. Studies need to be undertaken to determine if there is a need to modify the proportions of cement to be added to earth.

CEMENT TYPES CATEGORIZED BY THEIR COMPOSITION

FORMER STANDARDS	NEW STANDARDS
<p>CPA = clinker + Gypsum insolubles $\leq 3\%$</p> <p>Cement types with secondary constituents CPAL, CPAC, CPAZ, CPAL, etc.</p> <p>Type 400 15% \pm 5% secondary constituents Type 325 25% \pm 5% secondary constituents</p> <p>CPF slag 30% \pm 5 CMM slag 50% \pm 5 CHF slag 70% \pm 5</p> <p>CLK slag $\geq 80\%$</p>	<p>CPA = Clinker $\geq 97\%$ Filler $\leq 3\%$ Gypsum additional</p> <p>CPJ Clinker $\geq 65\%$ Sec. const. $\leq 35\%$ Gypsum additional</p> <p>CHF 60 to 75% slag Remainder = Clinker + Filler ($\leq 3\%$)</p> <p>CLK Slag $\geq 80\%$ Remainder = Clinker + Filler ($\leq 3\%$)</p>

Cement with too high a proportion of secondary constituents which are very sensitive during the curing stage should be rejected and include iron Portland cement (CHF); blast furnace cement; mixed metallurgical cement (CMM); slag clinker cement (CLK).

2. EARTH (fig. 281-282)

After shaping earth should possess good natural cohesion, i.e. the clay content should be sufficiently high: over 10%. It should also contain a mineral structure (sand-gravel) ensuring efficient action of the cement. Thus gravel and sand, silty and clayey, have the greatest potential and will result in the best stabilized materials. On the other hand, some constituents can have a negative physico-chemical effect on the action of cement. These include organic matter, sulfates, oxides and metal hydroxides.

● Organic matter

This is naturally present in the topsoil as well as in areas with a large amount of vegetable debris (peat). Certain writers consider that a small amount of organic matter in the soil can

be beneficial in the event of use without stabilization.

They cite, for example, certain reactions with iron which is also present. In the case of cement stabilization its presence is recognized as harmful: it delays setting and results in a lowering of strength. It is also undoubtedly true that the nature of the organic matter as much as the amount present determines its action on cement and on soil cement. Thus some organic matter appears to have only very little effect on soil-cement, and it should also be noted that secondary additives such as calcium chloride (CaCl_2) are likely to neutralize its negative effect.

As a general rule, until more precise knowledge has been acquired, earth containing organic matter should be rejected. In our view more than 1% constitutes a risk and earth containing more than 2% should not be used.

● Sulphates

The sulphate most frequently found in natural soils is calcium sulphate (anhydride and gypsum) and in many places its presence is associated with deteriorated earth constructions or with landslides. Suspicion then falls on the considerable swelling linked to the hydration of the Calcium sulphate. At the very least it should be considered to be particularly risky... It can in fact act in two different ways: it destroys the cement which has hardened within the soil-cement, particularly when this has been in contact with water containing dissolved sulphate (selenitic water) which increases its sensitivity to moist clay. This last reaction, which is not well understood at present makes it pointless to use cement which resists sulphates and it would appear that deteriorations in stabilized material are to be feared even with very low concentrations of sulphates. We recommend a specific study for soils containing more than 2 - 3% sulphates.

● Oxides and metallic hydroxides

Here we are referring mainly to iron and aluminium oxides which are rarely found in concentrations greater than 5% and which therefore have little effect. In lateritic soils, however, which contain them in high concentrations, efficient and rapid stabilization has been observed with small quantities of cement. This could be due to a pozzolanic-type reaction between the laterite and the lime contained in the cement. In the case of soils with high concentrations of aluminium oxide on the other

CLASSIFIED BY STRENGTH

Name of type	Sub-type if necessary	Compressive strength (in MPa)		
		up to 2 days		up to 28 days
		nominal lower limit	nominal lower limit	lower upper limit
35	—	—	25.0	45.0
45	R	15.0	35.0	55.0
55	R	22.5	45.0	65.0
T.H.R.	—	30.0	55.0	—

MINIMUM GUARANTEED VALUES OF COMPRESSIVE STRENGTH (IN MPa)

Types	2 days	7 days	28 days
35	—	10.0	25.0
45 45 R	10.0	17.5	35.0
55 55 R	10.0 15.0	—	45.0
THR	20.0	—	55.0

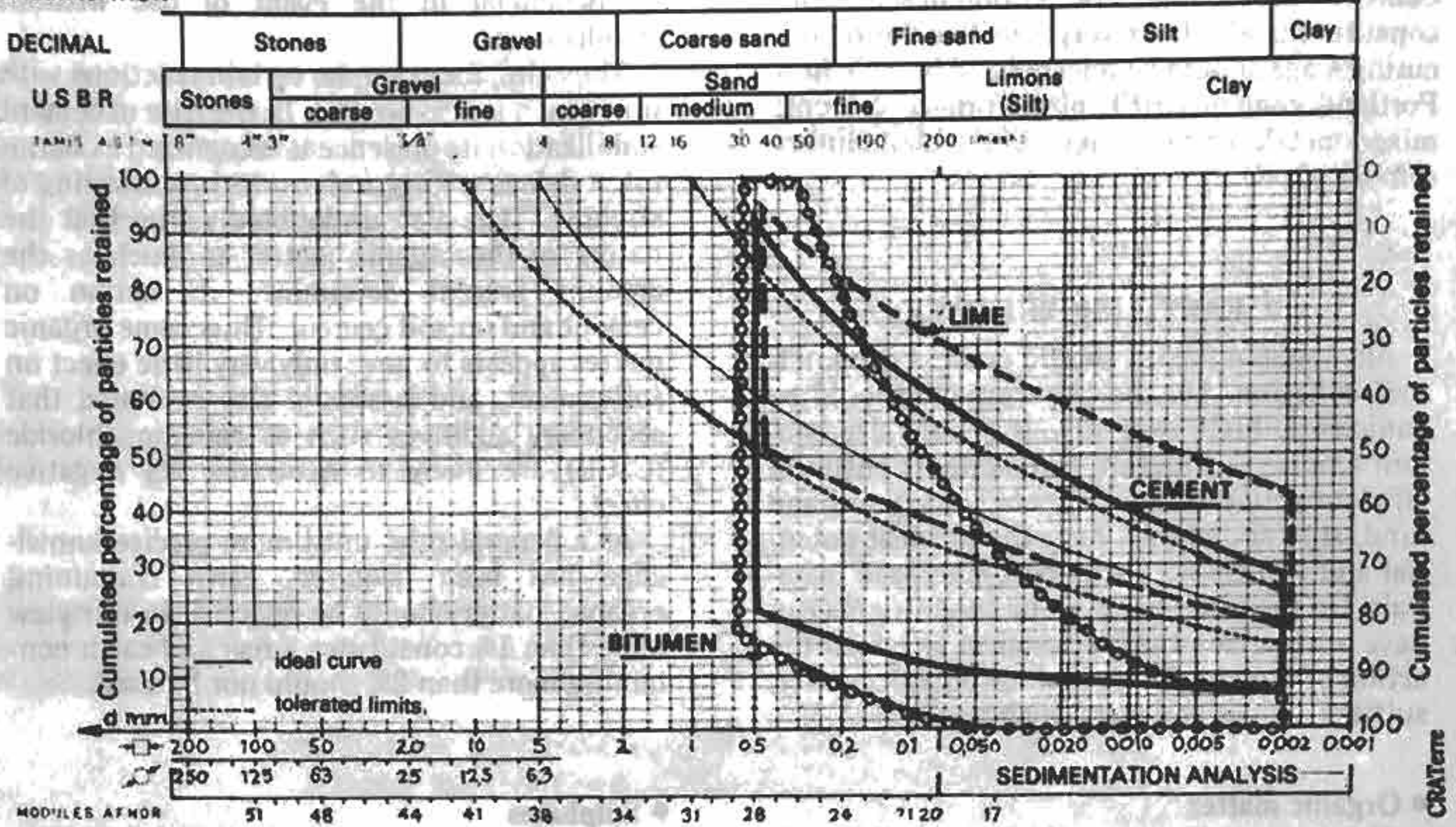

FIGURE 281:
STABILIZATION LIMITS
FOR CEMENT,
LIME, BITUMEN,
TAKING ACCOUNT
ONLY OF FINER
ELEMENTS
(BELOW 0.5 MM)

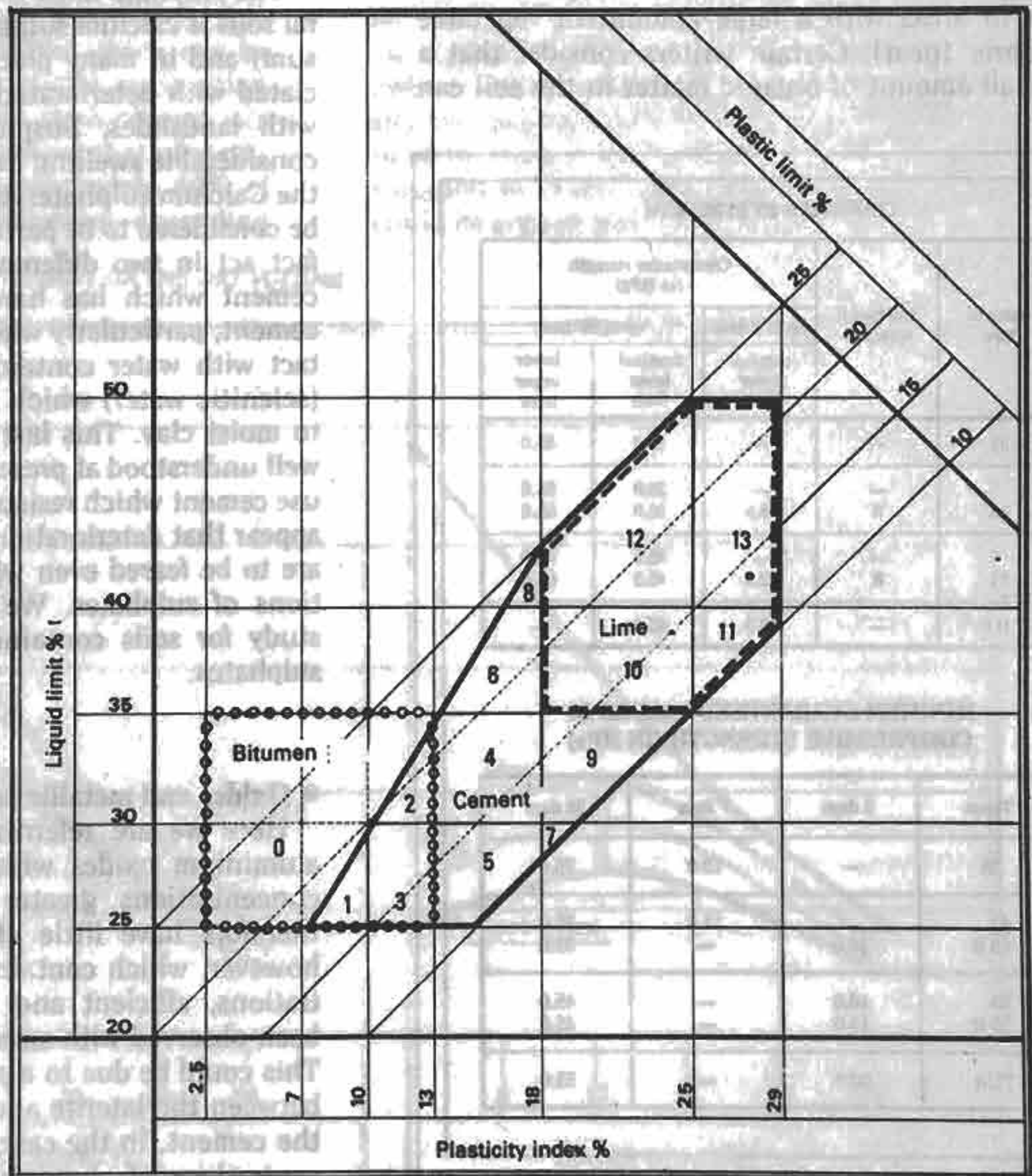

FIGURE 282:
STABILIZERS
AND THE
ATTERBERG LIMITS

hand a rapid increase in strength followed by a very slight reduction over time have been observed. This reduction in strength remains very small and could be attributable to a completely different cause than the concentration of aluminium oxide: faulty drying out for example.

The presence of these elements in the earth can thus generally be said to have no major effect and might even possibly be beneficial.

Effects of cement-stabilization

Adding cement naturally has an effect on the properties of the stabilized material, since this is the object of stabilization. One should be aware

• Water

The water required for mixing soils is not subject to precise specifications. In principle water containing large amounts of organic matter and salt water should not be used to the extent that they could provoke esthetically unacceptable efflorescences. Water which is rich in sulphates could also be considered undesirable given what has been noted above on the subject of the presence of sulphates in soil. But it should be said that any water, even very salty, will only add a very small proportion of salts to the mix.

that it also has an impact on the properties of the earth and its application.

EFFECT OF ADDING CEMENT ON THE CONDITIONS UNDER WHICH STABILIZED EARTH IS APPLIED

Cement added to soil modifies the particle size distribution of the material which can be expressed as a slight shift in the compaction curves. The Proctor optimum earth-cement mix can then differ considerably from that of earth. Cement is made up of approximately 80% of elements smaller than 80 microns; depending

on the quantity of cement added and the particle size distribution of the soil, the addition of cement can result in a lowering of the dry density coupled with an increase in the O.W.C. or in an increase in dry density with no significant variation in O.W.C. (fig. 283). At first sight, it could be argued that the lowering of dry density

FIGURE 283: EFFECT OF ADDING CEMENT ON THE DRY VOLUME

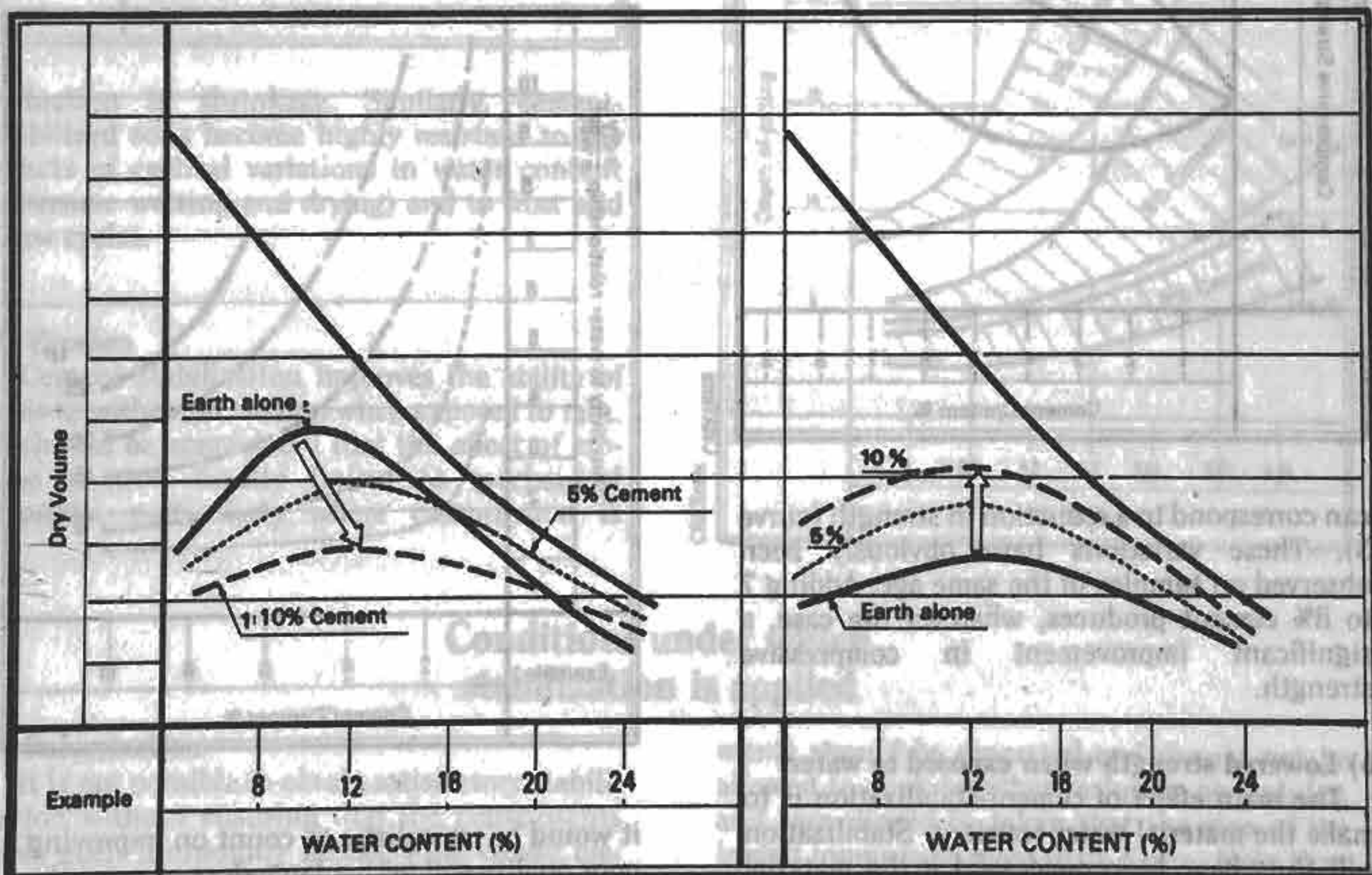

would occur particularly with earth which lends itself well to compaction, whereas the increase in dry density can be observed in soils which compact relatively badly (narrow particle size

range for example). As different reactions have, however, been observed, our advice would be to undertake compaction trials before going ahead.

EFFECT ON THE STABILIZED MATERIAL

a) Compressive strength (fig. 284)

The improvement in compressive strength can, depending on the soil treated evolve differently with changes in the cement content. The improvement can be rapid at low contents and then increase progressively more slowly (curve 1). It can be directly proportional to the cement content (curve 2). Finally, low cement contents

obtained shows only a limited reduction in mechanical strength after immersion. Careful treatment with cement can give highly satisfactory results. Thus with a soil the plasticity index of which was 15 and which after immersion had practically no compressive strength (σ_h), 2% cement gave a post-immersion strength equal to one eighth of the strength when dry (σ_s). With 5% cement post-immersion strength increased to a quarter of the strength when dry. The susceptibility to water of the material treated increases with the plasticity index of the earth, whilst better compaction and an increased proportion of cement decreases it (fig. 285). It would therefore be preferable to use a good soil and add an average amount of cement to it and

FIGURE 284: COMPRESSIVE STRENGTH AND CEMENT CONTENT FOR THREE SOILS

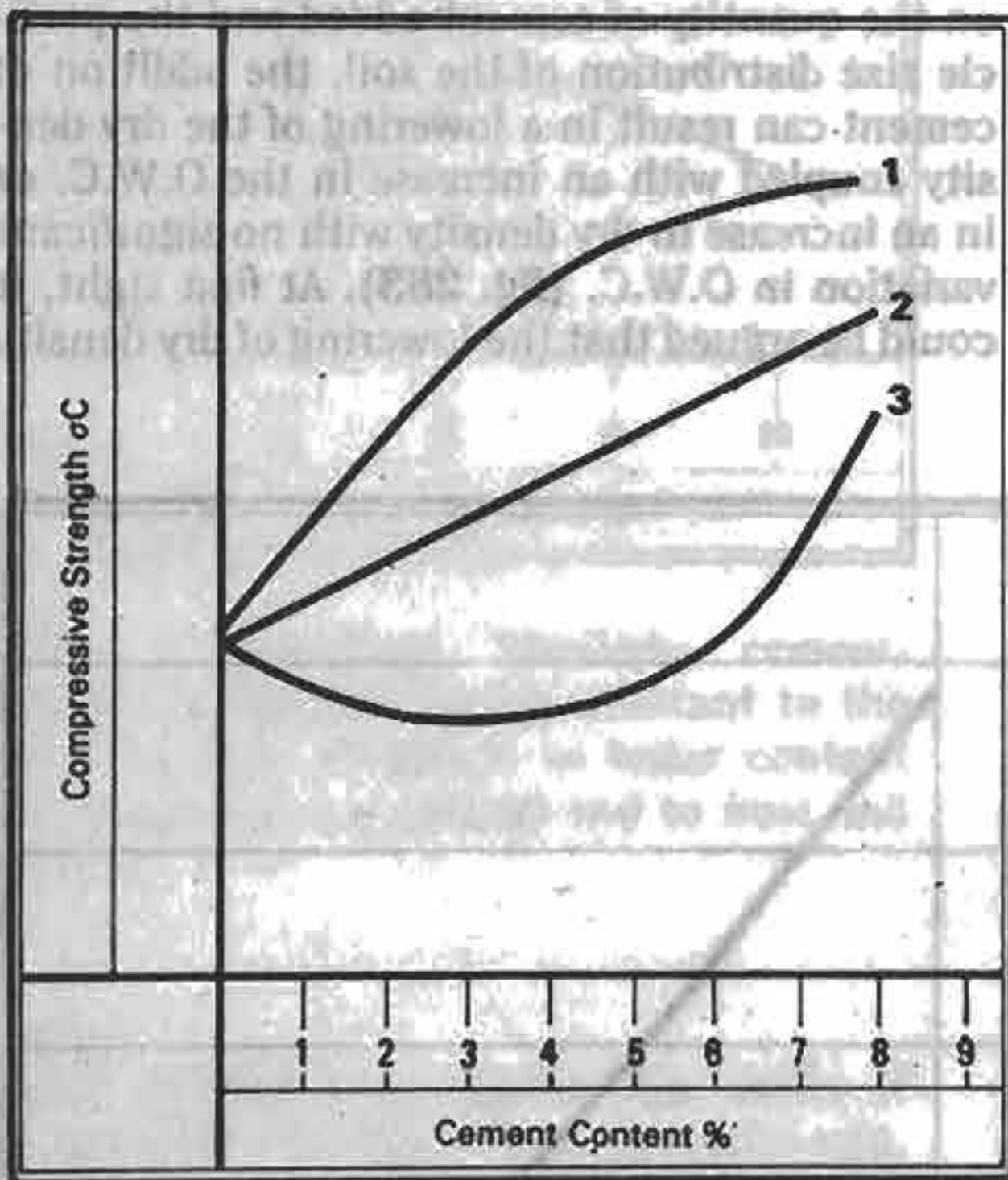

can correspond to a reduction in strength (curve 3). These variations have obviously been observed on samples of the same age. Adding 7 to 8% cement produces, whatever the case, a significant improvement in compressive strength.

b) Lowered strength when exposed to water

The main effect of cement-stabilization is to make the material water-resistant. Stabilization will thus have been successful if the material

FIGURE 285: WATER RESISTANCE IN RELATION TO CEMENT CONTENT AND LP FOR THE SAME COMPACTION

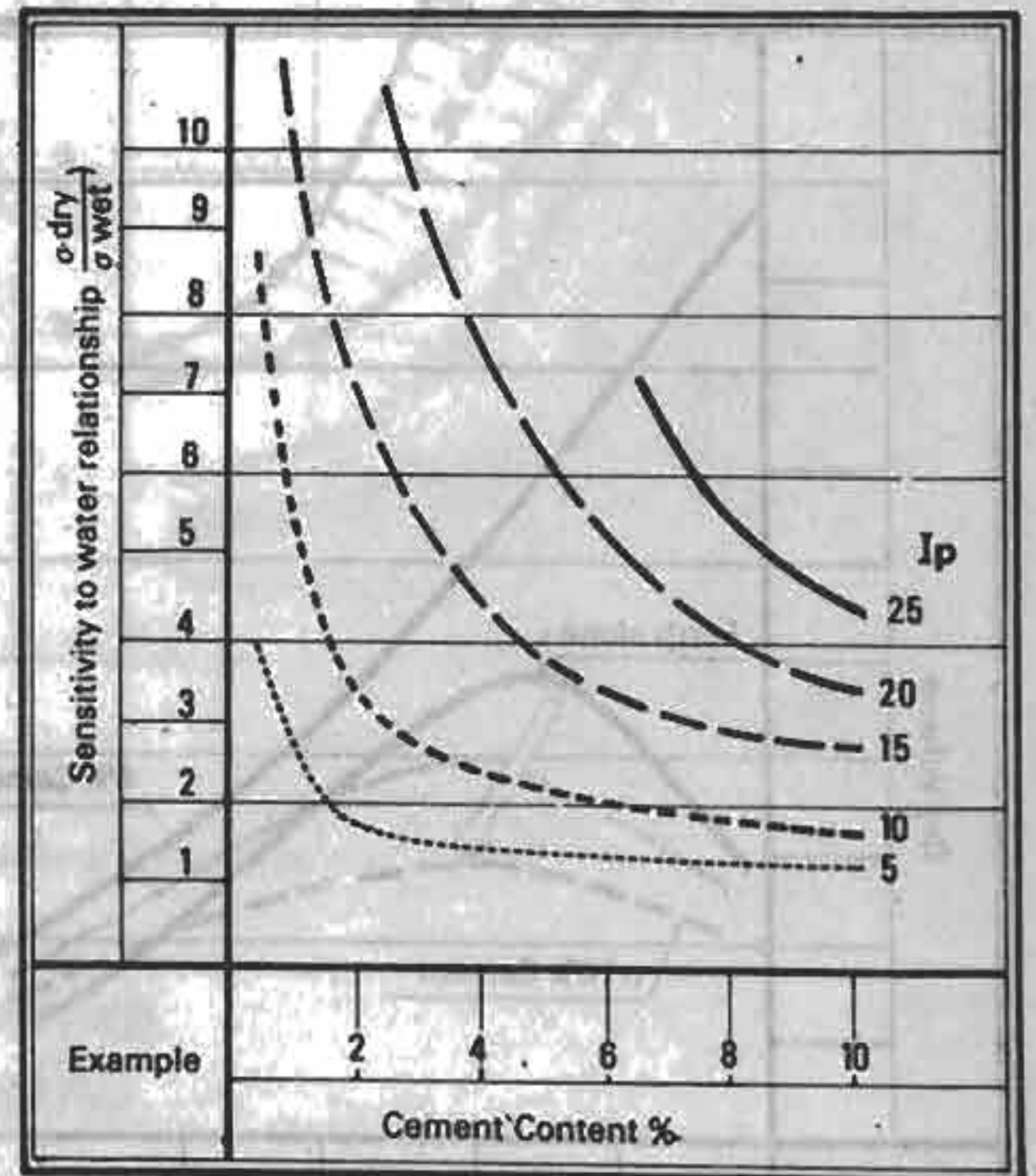

it would be unrealistic to count on improving a poor quality soil with a large dose of cement.

c) Size variations when exposed to water

Cement stabilization reduces the impact of shrinkage during drying and of swelling when wet. Thus with 5% cement, the total linear shrinkage can, depending on the earth, remain less than 1% which greatly reduces the risk of cracking (fig. 286). A higher proportion of cement does not generally afford any further

FIGURE 286: VARIATIONS IN SHRINKAGE WITH CEMENT CONTENT
LINEAR SHRINKAGE (%)

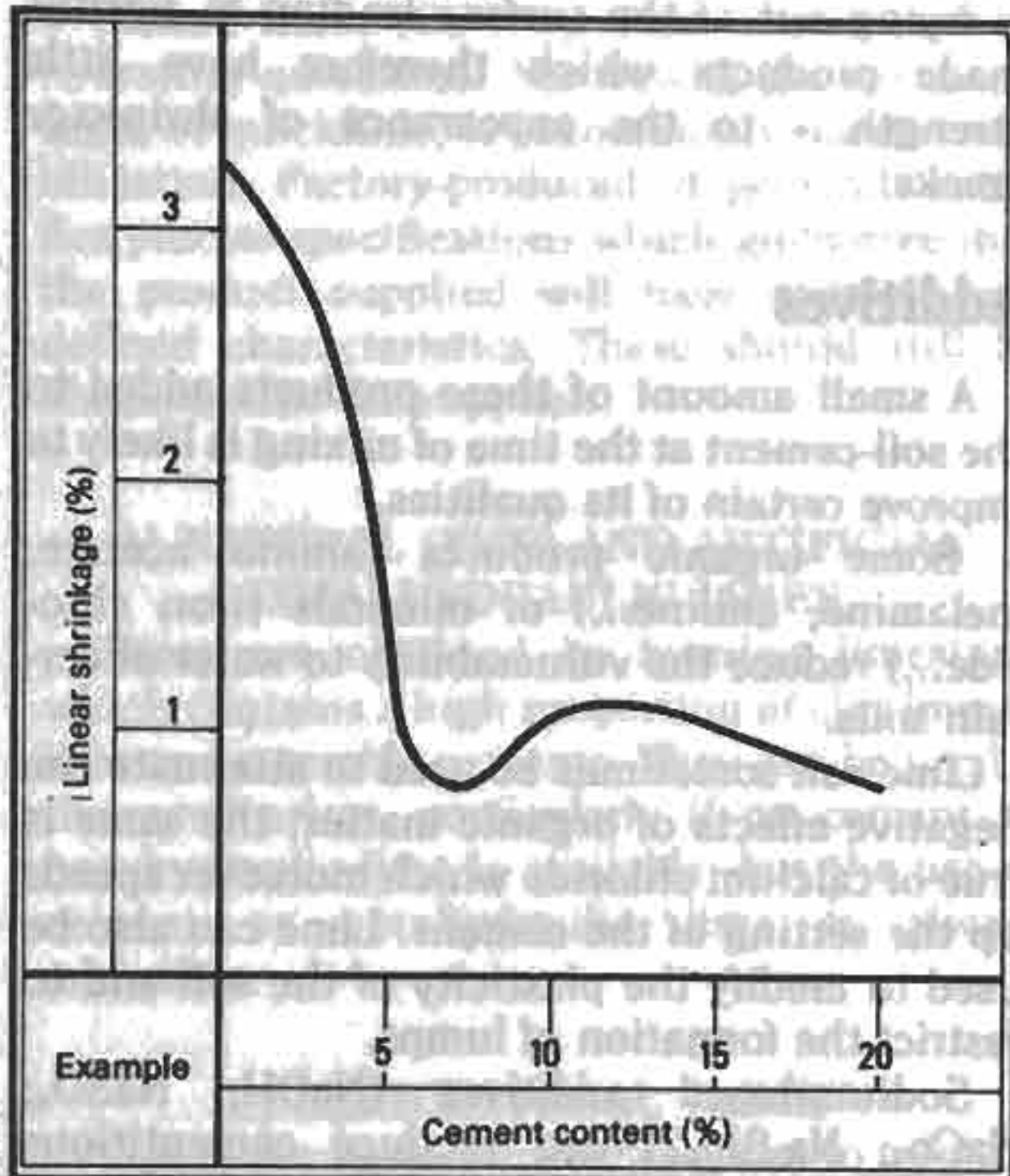

reduction in shrinkage. Similarly, cement-stabilized soils become highly resistant to the effects of cyclical variations in water content (alternate wetting and drying) and to frost and thaw cycles.

d) Erosion

Cement stabilization improves the ability of soils to withstand erosion when exposed to rain. It should be appreciated that the effect of erosion is not directly linked to mechanical strength, particularly where compression is

concerned: an earth block which resists crushing can disintegrate very quickly and vice versa. What is systematically observable is that an earth element whether stabilized or not displays better resistance to rain the more large particles it contains. A good correlation has thus been found between the action of rain on earth and D 50 (diameter in mm below which the particles represent 50% of the total weight of the earth.) Particle size distribution is thus the key factor in resistance to rain. Figure 287 represents the relationship, for various cement doses, between resistance to rain and D 50. This appeared in a note in the annals of the ITBTP of May 1976 (no. 339) by J.M. Gresnillon, reporting on experiments carried out in the Inter-State engineering college of rural works (Ouagadougou, Upper Volta). This note shows fairly exhaustively the effects the main parameters of cement- (and lime-) stabilization. The reader requiring more details is advised to refer to it.

FIGURE 287: RESISTANCE TO RAIN AND AVERAGE PARTICLE DIAMETER FOR DIFFERENT CEMENT CONTENTS

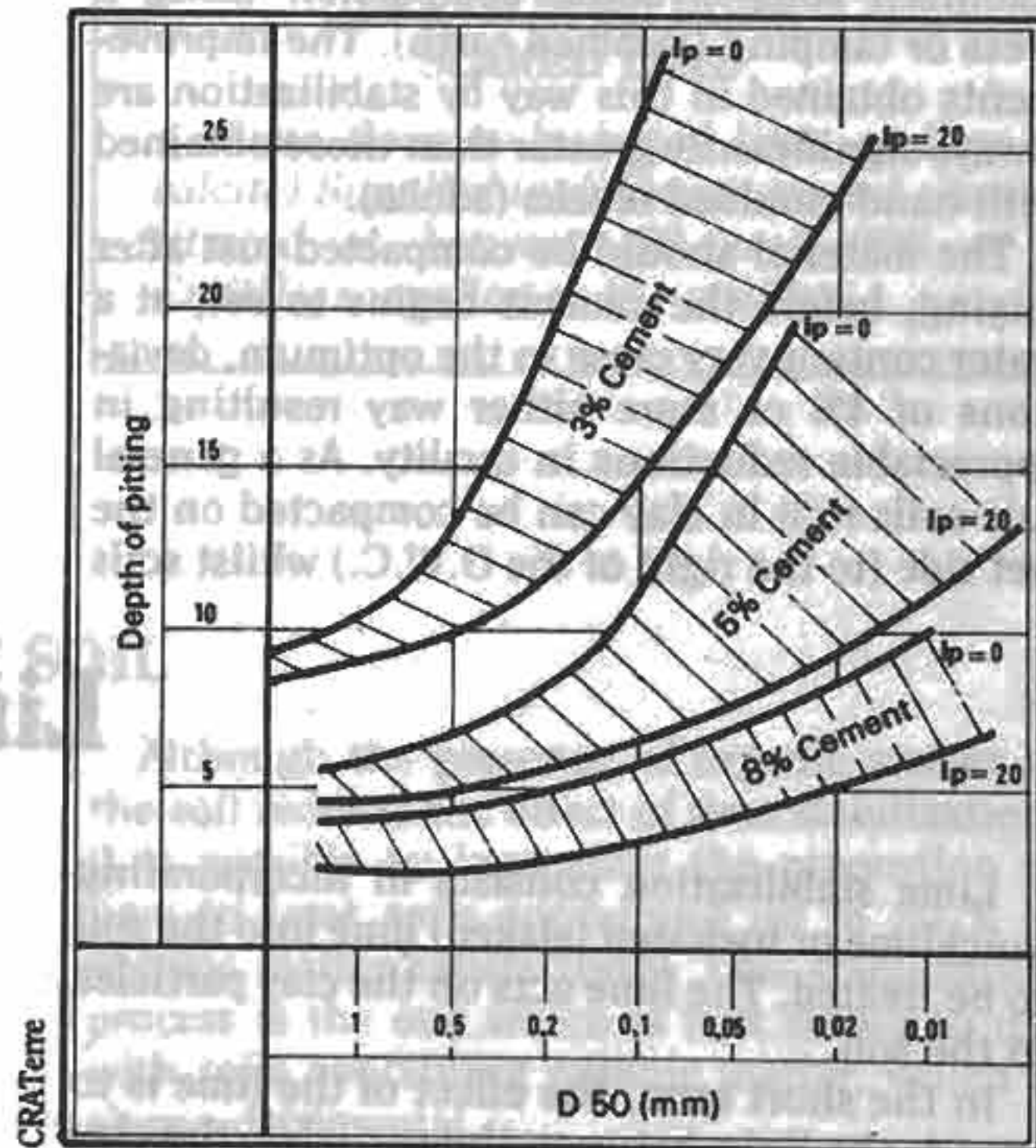

Conditions under which stabilization is applied

a) Pulverization

It is not possible to obtain satisfactory stabilization without ensuring that the constituents have been thoroughly mixed. Fine clayey ele-

ments should be separated and should not be allowed to stick together in lumps or nodules, and care should be taken that the size of the largest lumps is no more than 20mm. More than

50% of lumps larger than 5 mm is likely to reduce by half the compressive strength. For example, given a well pulverized soil stabilized with 8% cement and with a dry compressive strength of 25 daN/cm² (at 7 days), to obtain the same strength with the same soil but containing on mixing 30% of lumps greater than 5 mm, one would have to use 15% cement, with no guarantee of the result.

b) Mixing

Mixing determines the uniformity of the product and a good distribution of the cement. The best conditions for mixing are those when the soil is dry. This requires pre-drying of the soil - especially in wet regions - and highlights the importance of our earlier remarks on the subject of separating fine elements. The water required for moulding should be added only at the end of the mixing process. It should be noted that on site mixing is always less good than that obtained in laboratory conditions, particularly when it is manual. There is therefore a case for increasing the dosage of cement.

c) Moulding, shaping

The best process for shaping cement-stabilized soils is static compaction using a press or tamping (rammed earth). The improvements obtained in this way by stabilization are always significantly greater than those obtained with hand-moulded blocks (adobe).

The material should be compacted just after mixing, before the cement begins to set, at a water content very close to the optimum, deviations of 4% or more either way resulting in appreciable reductions in quality. As a general rule soils rich in clay can be compacted on the wet side (to the right of the O.W.C.) whilst soils

with a high proportion of sand will be on the dry side.

d) Curing (drying)

As is the case with concrete, soil-cement increases in strength over time. Not all soils behave in identical ways, but a curing time of 14 days is absolutely indispensable, and it would be preferable to wait 28 days. During this time the material should be kept in damp conditions, protected from direct sun and taking care to avoid too much wind. This is to avoid too quick a drying out of the surface leading in freshly-made products which therefore have little strength - to the appearance of shrinkage cracks.

Additives

A small amount of these products added to the soil-cement at the time of mixing is likely to improve certain of its qualities.

- Some organic products (amino acetate, melamine, aniline...) or minerals (iron chloride...) reduce the vulnerability to water of certain soils.

- Lime can sometimes be used to attenuate the negative effects of organic matter; the same is true of calcium chloride which moreover speeds up the setting of the cement. Lime can also be used to modify the plasticity of the soil and to restrict the formation of lumps.

Sodium-based additives (NaOH; NaSO₄; NaCO₃; Na₂SiO₂) can produce cementitious effects which complement that of the cement.

Various forms of bitumen, emulsified or cut-back, used in low dosages render the soil-cement waterproof.

Lime

Lime stabilization consists in incorporating quicklime or hydrated (slaked) lime into the soil to be treated. The lime acts on the clay particles in the soil.

In the short term, the effect of the lime is to modify the links between the particles: the clay takes on a flocculated structure, while the calcium ions introduced with the lime form

"bridges" between the particles.

In the longer term, the clay-lime reaction results in the appearance of new crystalline structures which cement the soil particles together. This phenomenon occurs only after a fairly long time (a fortnight at best) which implies the need to allow a period of storage.

I - DIFFERENT KINDS OF LIME

a) NON-HYDRAULIC LIMES

210 These are produced by burning very pure limes (limestone) and represent the main source

of lime used in for stabilization.

● **Quicklime:** (CaO). Produced directly by burning limestone, its usefulness is inhibited by the

delicate storage and handling it requires: it is extremely water-absorbent and caustic, and must be handled with care and stored in dry conditions until it is ready for use. Quicklime, which slakes when in contact with water, heats up violently and can reach temperatures in excess of 150°C. It can, however, have some advantages over slaked lime: in wet soils, it absorbs the water it requires for its hydration. Weight for weight, it is more efficient insofar as it introduces more calcium ions.

● **Slaked lime:** $(CaOH)_2$. This is obtained by hydrating quicklime. Not having the disadvantages of quicklime, it is commonly used in stabilization. Factory-produced, it generally satisfies precise specifications which guarantee that the product supplied will have certain well-defined characteristics. These should still be checked with the supplier.

b) NATURAL (XHN) AND ARTIFICIAL (XHA) HYDRAULIC LIMES

These are obtained by burning limestone which contains a high proportion of clay impurities and resemble cements. They can be used if the need arises, particularly if no cement or non-hydraulic lime is available; but the use of cement or non-hydraulic lime is always preferable.

c) AGRICULTURAL "LIME"

This is the name sometimes given to calcium

carbonate crushed and used as manure for agricultural purposes. It has no stabilizing effect.

COMMERCIALY AVAILABLE NON-HYDRAULIC LIMES

PURE QUICKLIME IN ROCK FORM

Supplied in bulk in sealed bags, this is in the form of blocks which have to be broken up before use.

PULVERIZED PURE QUICKLIME

Ground from 0 to 2 mm this is too coarse for general use.

VENTILATED PULVERIZED PURE QUICKLIME

Containing 50% elements smaller than 80 microns and 90% elements smaller than 200 microns. Supplied in bulk or in sealed bags. Can be directly used.

VENTILATED PURE SLAKED LIME

(Lime flour or hydrated lime, or lime calcite) Supplied in different ground sizes titrated at between 90 and 99% of $Ca(OH)_2$ according to the quality.

II - THE SOIL

The soils should contain a significant amount of clay since it is with clay that lime reacts. Plastic limits of between 4 and 9, or better still 10 to 13 are preferable. Even then, the soil will have to meet conditions ensuring that good compaction can be obtained. Depending on the nature of the clay minerals present in the soil (kaolinite, illite, montmorillonite...) the results obtained will vary appreciably.

Although the presence of organic matter in the soil reduces the effect of lime stabilization, it is possible by increasing the proportion of lime to treat soils containing up to 20 % of organic matter satisfactorily. This stabilization process is the one which is best suited to use with soils containing organic matter, which is always detrimental.

III - EFFECTS OF LIME STABILIZATION

Adding a small proportion of lime to a clay soil brings about a rapid change in its properties. It becomes less plastic and reacts better when exposed to water. The Proctor curves flat-

ten out, indicating less susceptibility to water.

Compressive strength, especially of soils rich in kaolinite, increases substantially in the medium and long term. For more detail on this, 211

one should refer to articles by A. Le Roux published in nos. 40 and 61 of the "Bulletin de liaison des laboratoires des Ponts et Chaussées". Very satisfactory results are obtained for lime contents, depending on the earth, ranging between 3 and 8%. Lime is suited to soils con-

taining a relatively high proportion of lime; it can accommodate a certain proportion of organic matter and can under these conditions result in strengths comparable to those obtained by cement stabilization.

IV - CONDITIONS UNDER WHICH IT IS APPLIED

a) MIXING

As with cement, this must be carried out with particular care, in order to obtain a thorough mix of lime and earth. For very plastic soils, it is possible to proceed in two stages at one- or two-day intervals, in order to give the lime time to break down any lumps. The lime thus makes the soil easier to handle, but its effect on strength risks being diminished.

b) COMPACTION

This should be carried out at a water content close to the optimum (or on the wet side), immediately after mixing for small lime proportions (2%) and after a few hours (2 to 6 hr) for high proportions.

c) DRYING

Compressive strength increases after application over time. This is due to the appearance of new minerals as a result of the reaction of the lime and clay. This phenomenon extends over several months, and occurs best in hot humid conditions (fig. 288).

FIGURE 288: LENGTH OF CURING TIME AND STRENGTH

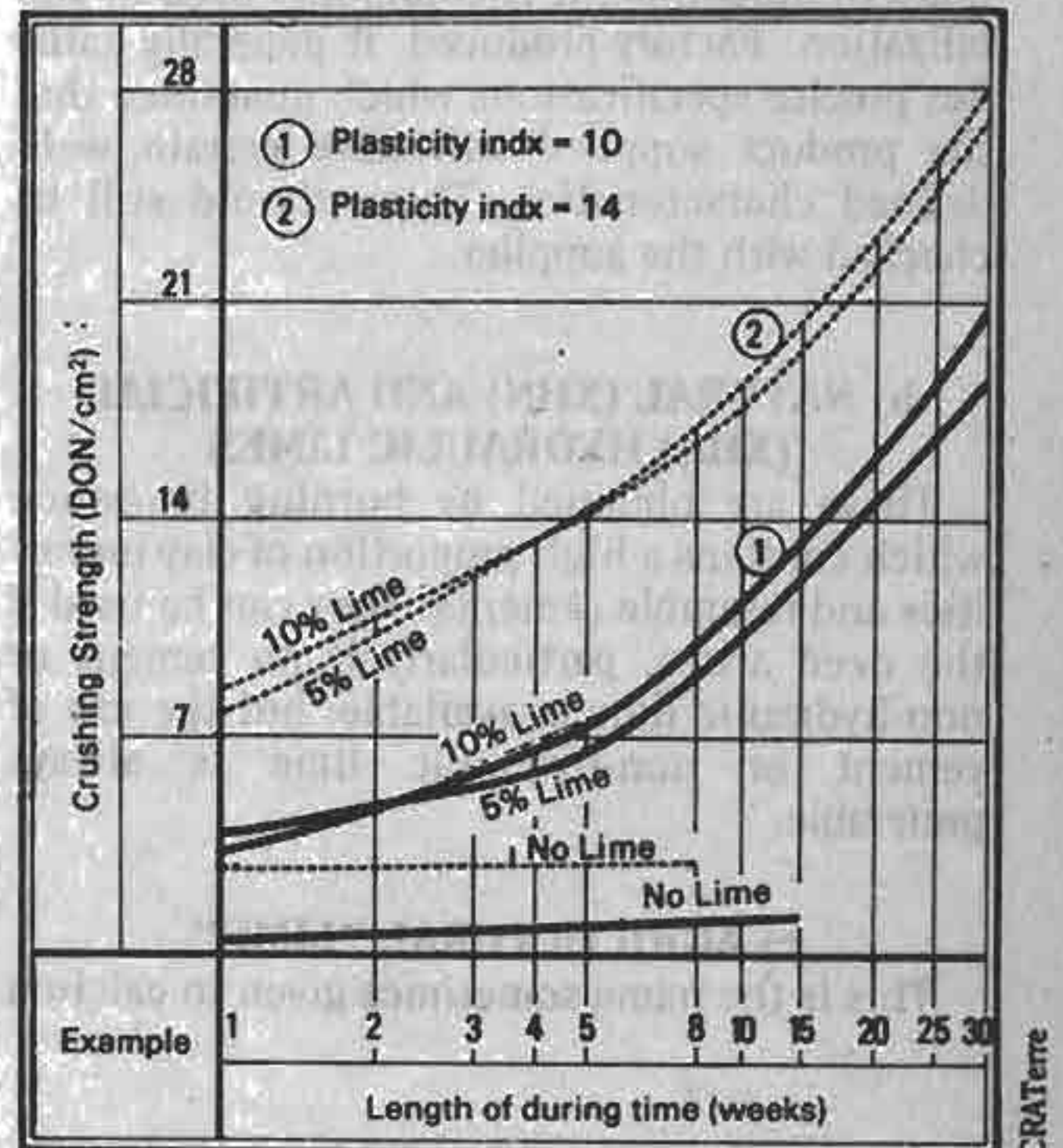

V - ADDITIVES

As with cement, certain additives can be used including sodium additives intended to improve

the effects of stabilization.

Bitumen

Terminology*

Often associated with road surfaces, bitumen should not be confused with asphalt, various kinds of tar, macadam etc.

The term "bitumen" originates in Sanskrit, where one finds the words "jatu" (pitch) and "jatu krit" (generator of pitch) by analogy with resins obtained from certain conifers. The Latin equivalent appears to have been "pix-tumens" or "exuding pitch" (i.e. exuded from the earth's

crust) and later "bitumen", under which form it passed into European vocabulary.

Originally, bitumen was used to designate a natural product made up of a "mix of hydrocarbons with a high molecular weight, soluble in carbon sulphur, and which could contain varying proportions of mineral."

* After the revue of the "Syndicat Professionnel des Producteurs et Entrepreneurs d'Asphalte" (The Asphalt Producers and Exploiters Professional Syndicate), special edition, June 1972.)

As for the term asphalt, this comes from the word "asphaltu" which gave the Greek adjective "asphales" (durable) and designates "a sedimentary rock, generally lime-based, and naturally impregnated with native bitumen in proportions of 8 to 10%"

Nowadays, bitumen is used to designate a product made up of at least 40% of heavy hydrocarbon and filler (mineral powder). The term asphalt is applied to products containing less than 20% hydrocarbons, the remainder being made up of filler, sand or gravel.

Care must be taken to avoid confusion which could arise from the American use of the word "asphalt": in the U.S.A., this is used to designate what in Europe is known as "bitumen". In the U.S.A. "bitumen" on the other hand refers to a black bonding agent used in distilled bitumen as well as in coal tar.

To be usable bitumen has to be heated or mixed with solvents (fluidified bitumen or cut-back) or dispersed in water (emulsion). It is under these last two forms that bitumen is used for stabilization.

PRINCIPLE OF BITUMEN STABILIZATION

Stabilizing a soil with bitumen affects the finest particles (clay and silt), the only elements which are unstable when exposed to water. Thus stabilizing the clay part of the soil is sufficient to stabilize the whole soil.

Cut-back (fluidified bitumen) or emulsified bitumen take the form of microscopic droplets in suspension in a solvent or in water. To begin with, this stabilizing liquid is mixed with the soil. Then when the "solvent" has evaporated, the bitumen droplets stretch to form a very fine membrane which adheres to the surface of the

soil particles, completely coating them. This coating is so thin that the soil is barely coloured. Once dry, the soil has nearly the same mechanical properties as an untreated soil, but the clay particles can no longer absorb water (nor lose their cohesion) and the soil is therefore more water resistant. In addition the bitumen lends further cohesion to soils which are not naturally very cohesive and improves their mechanical strength. In that event it acts as a binding agent.

FLUIDIFIED BITUMEN OF CUT-BACK

This is bitumen which has been fluidified or cut-back with volatile solvents including diesel, kerosene, and naphtha.

Depending on the nature and proportions of the solvents, cut-backs will be fluid and inflammable to a greater or lesser extent. The speed of evaporation of the solvent will also depend on the nature of the solvent, the cli-

matic conditions and the nature of the soil with which it is mixed. There are three types of cut-back: slow-drying, semi-fast and fast.

Certain additives can also play a part, these include tensio-active products which are said to improve adherence. The table below lists the main cut-backs.

CUT-BACKS (European classification)						ASTM American classification
	Type	Ignition point (°C)	Pumpability	Solvent	% Solvent	Type
Slow drying	SC 0	38	20	Diesel	50-55	SC 70 SC 250
	SC 1	66	45		39-45	
	SC 2	79	60		30-37	
	SC 3	93	75		25-30	
Semi-fast drying	MC 0	38	20	Kerosene	35-39	MC 70 MC 250
	MC 1	38	45		28-32	
	MC 2	65	60		23-27	
	MC 3	65	78		18-21	
Fast-drying	RC 0	0	20	Naphtha	35-38	RC 70 RC 250
	RC 1	0	45		27-30	
	RC 2	27	60		22-66	
	RC 3	27	78		17-21	

Viscosity is measured by indicators 0 to 3:

0 = very fluid

1 = fluid

2 = semi-viscous

3 = viscous

The ignition point is the minimum temperature to which the bitumen must be heated before the vapours ignite when exposed to a flame in standard conditions. This gives some

idea of the fire risk.

"Pumpability" is expressed by the minimum temperature necessary to pump the cut-back.

NOTE: RC 250 (Rapid curing road oil) has been used for adobe by the International Institute of Housing Technology (IIHT) of the University of Fresno, California in a series of trials which proved entirely satisfactory.

EMULSIONS

Here the bitumen particles are dispersed in water (or conversely water is dispersed in bitumen) with the help of an emulsifier. The emulsions generally contain 55 to 65% bitumen for 1 to 2% emulsifier. The latter facilitates the emulsification and maintains the bitumen in suspension in the water. The later separation of the water and the bitumen is known as its break-down or separation.

There are two kinds of emulsion:

- anionic: uncommon, and not suitable for all particle distributions;

- cationic: more widespread and compatible with nearly all soil types.

The emulsions are generally very fluid and can be easily mixed with a soil which is already wet. The speed of break-down of the emulsions depends mostly on the nature and quantity of emulsifier used. There are three types of break-down: slow, semi-fast, and fast. A slow break-down enables the finest elements to be treated. Adherence to the particles depends on the emulsifier and the tensio-active agents which may have been incorporated.

Emulsions are much less stable than cut-backs: the water and the bitumen can separate

(due to too long a period of storage, frost, vibrations during transport). It can sometimes be necessary to add stabilizers if long-distance transport on poor roads is necessary.

The table following list emulsions according to the American classification (ASTM). In France, they are differentiated by the percentage in weight of the binding agent they contain and by their viscosity.

Emulsions: ASTM classification		
Break-down	Emulsion	Comment
Slow	CSS 1 CSS 1 h	Fluid Viscous
Semi-fast	CMS 2 CMS 2n	Fluid Viscous
Fast	CRS 1 CRS 2	Fluid Viscous

Note: It is mostly in the form of emulsion that bitumen is used in the U.S.A. for the industrial production of adobe bricks.

BITUMEN DOSAGE

The principle of bitumen stabilization being to coat the particles with an impermeable layer, the dosage will above all depend on the specific surface area of the material; and thus on the nature and quality of the particles of which it is made up. For road works, formulas are used to calculate the optimum quantity of bitumen for a given particle size distribution. These quantities can often be relatively high (5 to 20%) since over and above its stabilizing effect, bitumen also acts as a binding agent. In our view it is not possible to apply these formulae to the specific problems of constructing buildings. It is worth bearing in mind that stabilization is only of any

real interest with low proportions of stabilizer. It is therefore essential to start with a good soil, and not to rely too much on the "miracle cure" effect of any product intended to improve the material.

The IIHT (California) recommends that for adobe tests be carried out progressively increasing the quantity of bitumen as follows:

CUT-BACK	EMULSION
2%	3%
3%	4%
	5%
	6%

Each test should be done on 3 or 4 samples which are checked for compressive strength, tensile strength, and water resistance (sprinkling) (cf. chapter on "Characteristics of the material") until satisfactory results have been obtained. The same organization notes that

soils too rich in clay which require more than 3% cut-back or 6% emulsion are not generally suitable for producing adobe bricks because of their tendency to have shrinkage cracks which are too large.

THE SOIL

The most suitable soils are classified in the lower area of the particle size distribution limits (fig. 281). Only plastic soils from zones 0 and 1 are really suitable. In dry areas those from zones 2 and 3 can be suitable (fig. 282).

Soils containing soluble salts (chlorides and sulphates) can deteriorate if they are subjected to cycles of wetting and drying. The IIHT (California)

takes 0.2% as the maximum permissible salt content. This figure strikes us as extremely severe. In our view it applies above all to the production of very high quality bricks achievable in the context of industrialized production. Higher salt contents should be acceptable depending on the proposed use of the products and their role in the building.

EFFECTS OF STABILIZATION ON BITUMEN

● Influence on the Proctor diagramme

Bitumen results in a lowering of density and an increase in the optimum liquid (water × bitumen) content. The curve is therefore flatter and the O.W.C. less precisely defined.

● Compressive strength

Dry strength increases with the proportion of bitumen until a certain threshold and then decreases alarmingly (fig. 289). Once the ideal coating has been achieved, the additional bitumen acts as a lubricant.

Wet strength increases regularly with the quantity of bitumen independently of dry strength.

● Water absorption

The quantity of water absorbed becomes very small beyond a certain point which is worth pinpointing (fig. 290). A temperature of 40°C during mixing, moulding and curing reduces absorption, higher temperatures bringing no further benefits.

FIGURE 289:
DRY STRENGTH, WET STRENGTH

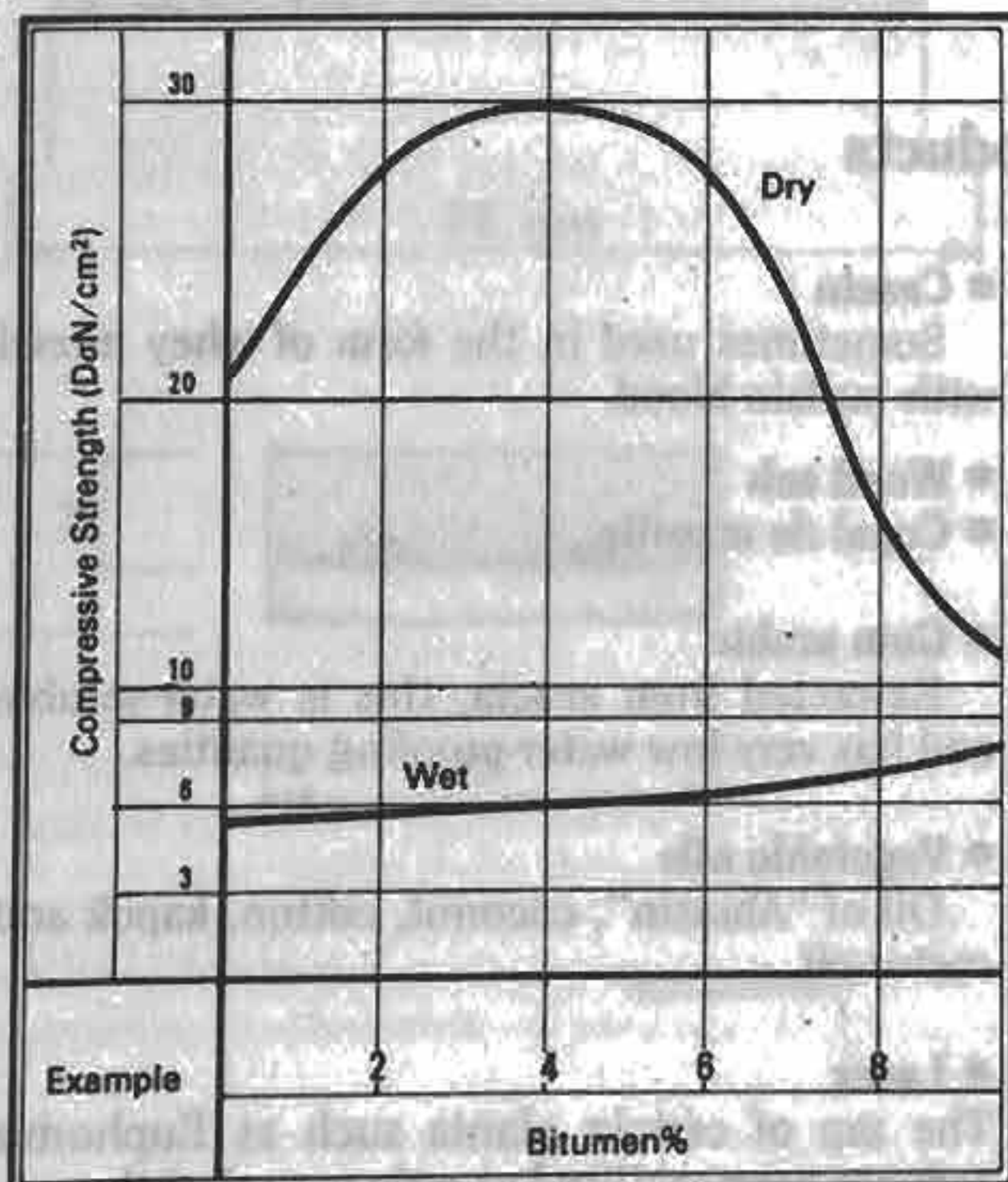
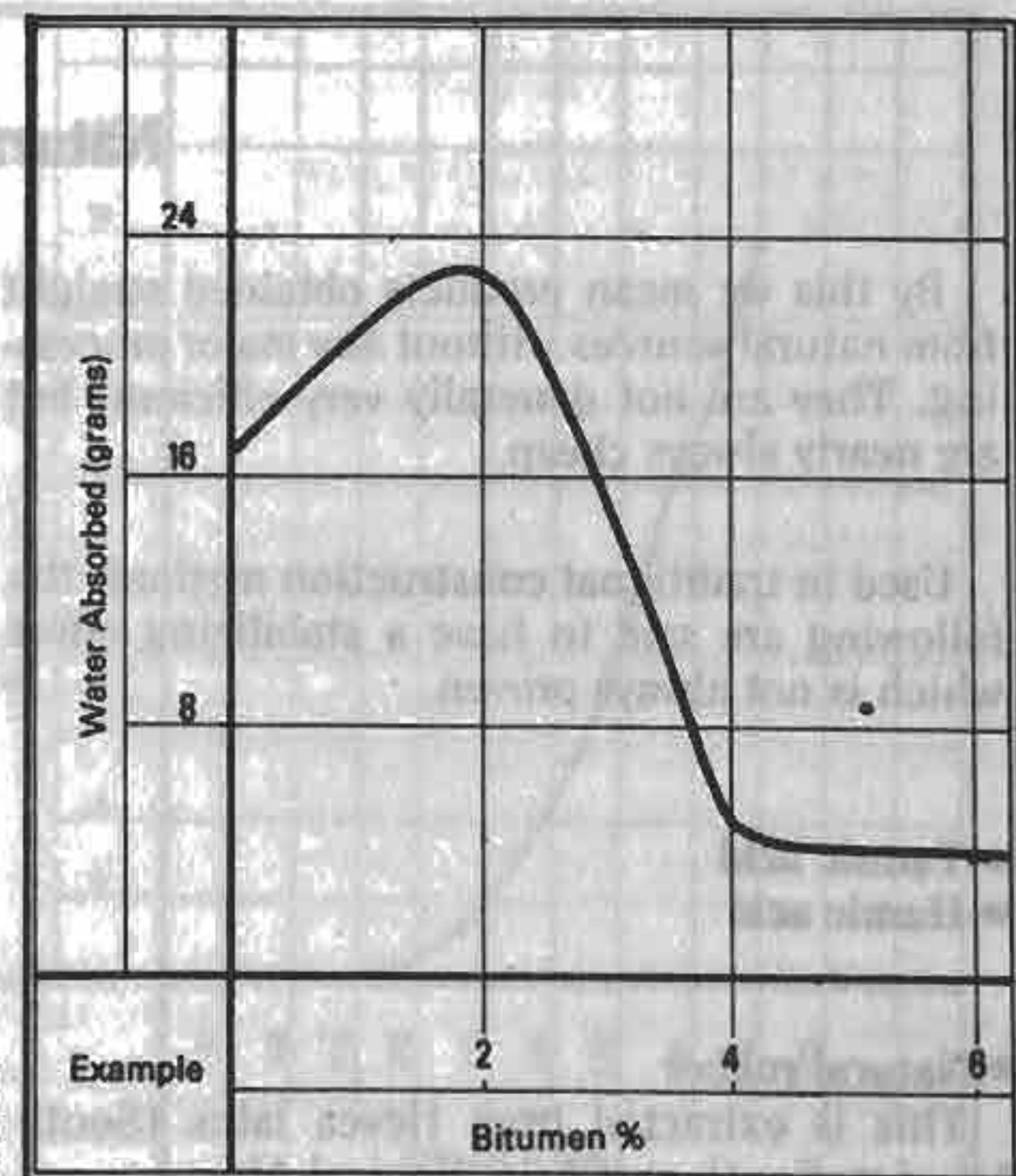

FIGURE 290:
WATER ABSORPTION TEST



MIXING

The mixing process has considerable importance on stabilization as too much can increase water absorption after drying. Too vigorous mixing can indeed provoke an early "break-down" of the emulsion.

There are two methods of mixing according to whether the earth is to be compacted or not.

a) **The earth is not to be compacted** (adobe, direct moulding, mortar, render).

The mix is carried out at water contents well above the O.W.C. Hand mixing is easy, and the homogeneity of the product is excellent.

b) **The earth is to be compacted** (rammed earth, compressed blocks)

It is important for compaction to have a soil with a water content close to the optimum as defined by the Proctor test. If the soil is naturally humid, the amount of liquid added with the stabilizer may raise the water content above that of the Proctor optimum.

In this event the earth should be dried and longer production time should be allowed for. Hand-mixing of earth at the O.W.C. is laborious and the mix will be less homogeneous than with a wetter soil. The wet strength and impermeability will therefore often be less good. On the other hand, the compaction and unmoulding of compressed blocks will be easier and the bricks will have perfectly sharp edges as bitumen acting as a lubricant facilitates the removal of the mould.

Unconventional stabilizers

Under this heading we group together all the other stabilizers that can be used for earth. Our intention is not to imply that these are of secondary interest. But they are much less commonly used than cement, lime or bitumen and the way in which the stabilization is

achieved is often poorly understood.

They can be classified into three main groups:

- Natural products, vegetable or animal;
- Industrial products;
- Commercial stabilizers.

Natural products

By this we mean products obtained straight from natural sources without any major processing. They are not generally very efficient, but are nearly always cheap.

Used in traditional construction methods the following are said to have a stabilizing effect which is not always proven.

- Tannic acid
- Humic acid

● Natural rubber

This is extracted from Hevea latex (South America, South-east Asia, tropical Africa).

● Casein

Sometimes used in the form of whey mixed with buffalo blood.

● Wood ash

● Copal de manille

● Gum arabic

Extracted from acacia, this is water-soluble and has very low water-proofing qualities.

● Vegetable oils

Oil of "Abrasin", coconut, cotton, kapok and castor-oil.

● Latex

The sap of certain plants such as Euphorbia reduces permeability but only very slightly.

● Straw

Straw is very widely used in all techniques relating to plastic and "liquid" earth. Its stabilizing effect is somewhat debatable. It has been proved that the lactic acid which forms when the straw has decomposed after a week in the mud has no improving effect.

Straw should really be considered as a reinforcing agent in the same way as gravel, or better still as the fibre glass incorporated into reinforced plastics.

It fulfills a number of functions:

- preventing cracking on drying by spreading the stresses caused by the shrinking of the clay across the entire mass of the material;
- speeding up the drying, the straw ducts serving to drain the humidity towards the exterior of

the material;

- reducing the weight of the material. The volume of straw commonly used is often as much as half the volume of earth. The material is consequently a great deal less dense and its thermal insulation improved;

- increasing tensile strength. This is certainly the greatest advantage of using straw. Tests were carried out in the German Democratic Republic in the 50's on reinforced floor elements in "light earth" (leicht lehm). The material was a mix of earth with 70 kg of straw per m³ of earth, which gives a volume of 40% fibres. The elements measured 70 × 32 × 11 cm and were reinforced by two sticks of 5 cm² sections each. The table (fig. 300) shows the results of a flexion strength test where the load is concen-

FIGURE 300: FLEXION STRENGTH

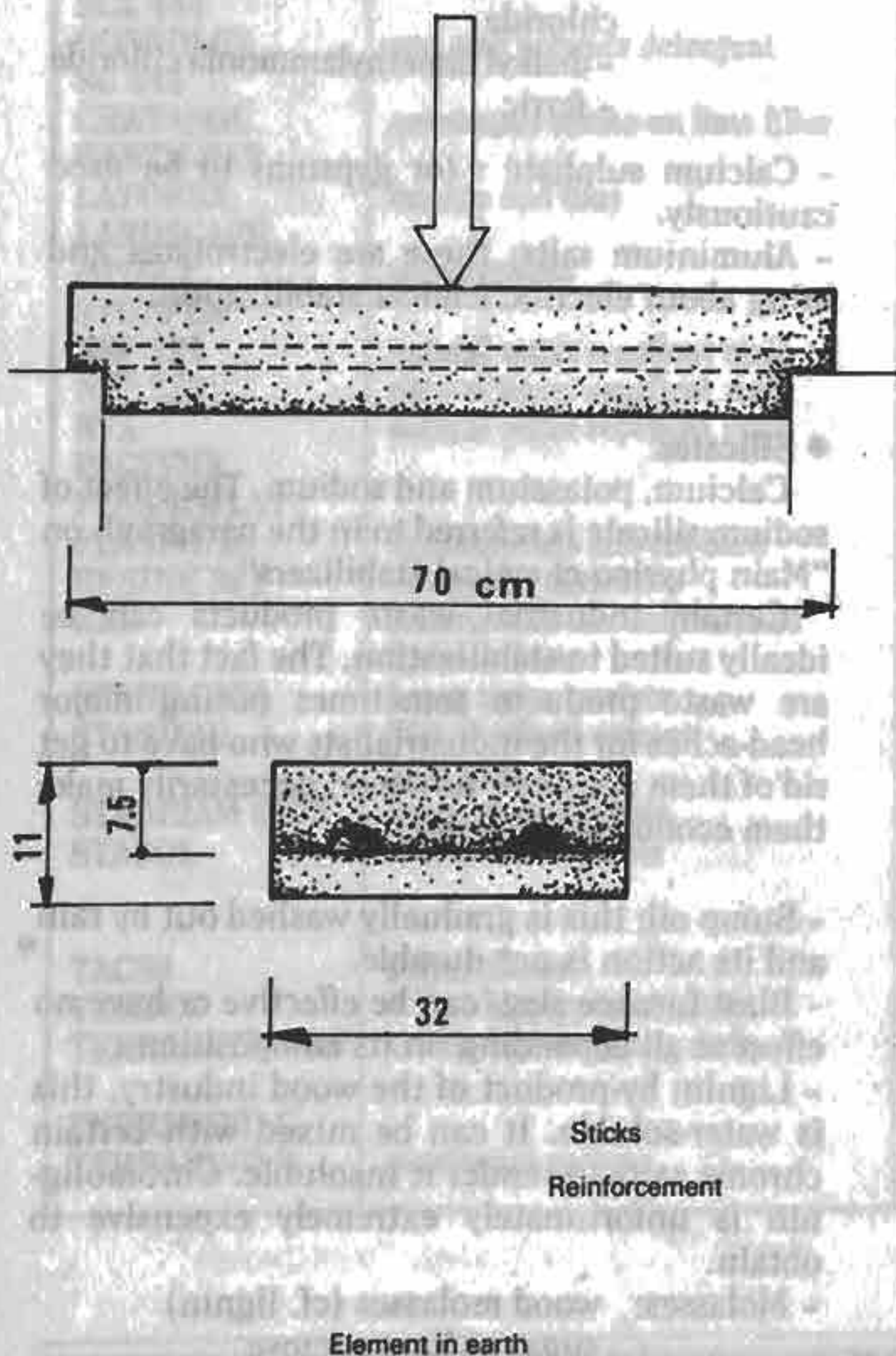

The element's strength

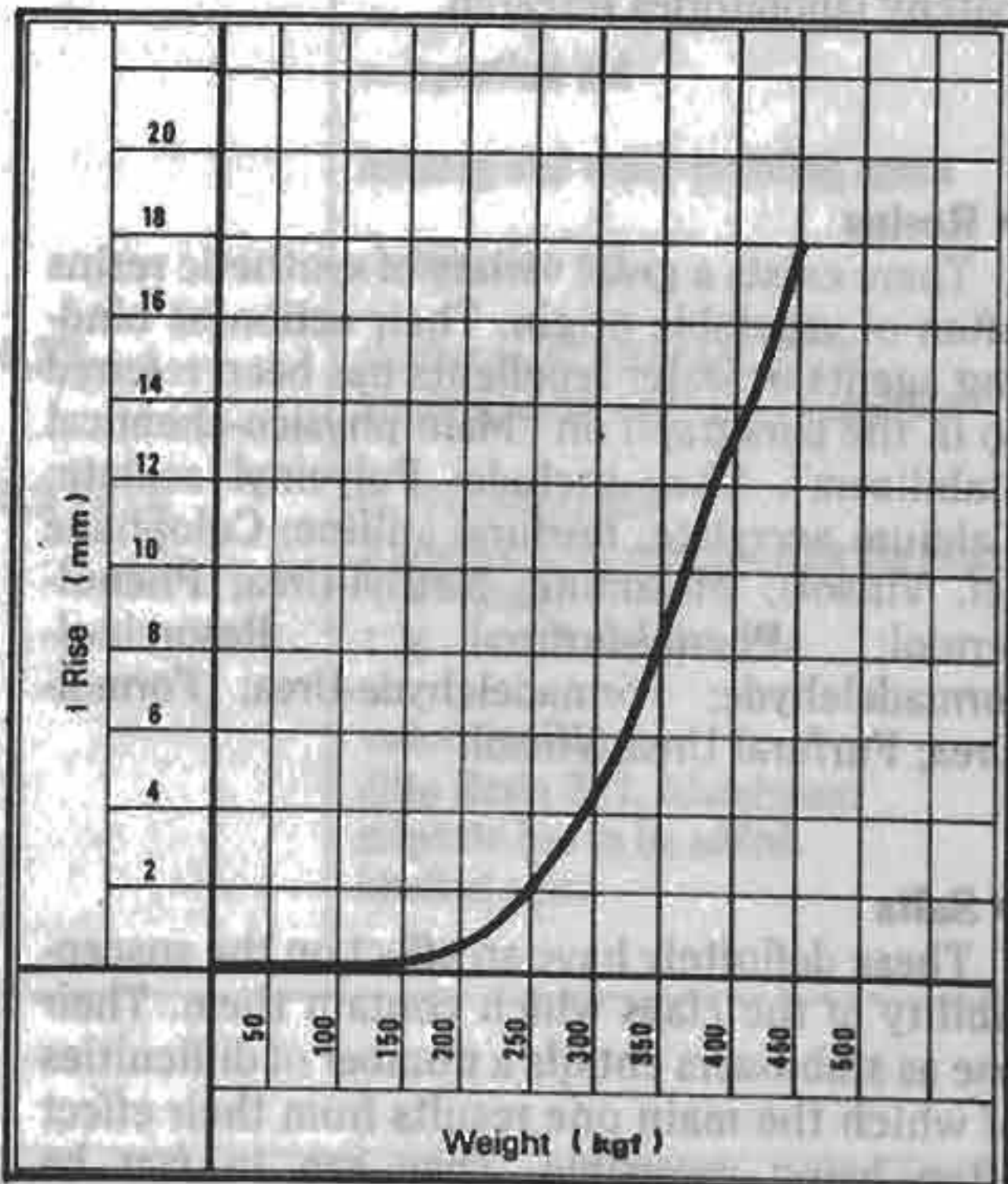

Pollack, Richter

trated in the middle of the element. The results obtained were surprising since breakage occurred with a charge of 450 kg over an 18mm span.

● **Palmo-copal**

Copal is a resin extracted from certain tropical trees. Palmo-copal is a solution of copal obtained by pyrogenation from palm-oil (4 parts copal to 6 parts oil). 3 to 8% of palmo-copal is added to the soil.

● **Acids**

Always to a greater or lesser extent dangerous to handle in concentrated form and even diluted, acids modify the pH of the soil with which they are incorporated, which results in flocculation, the effects of which are unfortunately not permanent. Some acids are incorporated into commercial stabilizers.

Phosphoric, hydrochloric, sulfuric, nitric, and hydrofluoric acids have been the subject of patchy laboratories research.

● **Resins**

There exists a great variety of synthetic resins often of vegetable origin. Their action as binding agents or water repellents has been referred to in the paragraph on "Main physico-chemical stabilizers". They include: Polyvinyl acetate; Calcium acrylate; Furfural aniline; Colophane (cf. Vinsol); Melamine; Methyl-Urea; Phenol-fermol; Phenol-furfural; Resorcinol-formadehyde; Formadehyde-Urea; Formol-Urea; Furfural Urea; Vinsol.

● **Salts**

These definitely have an effect on the susceptibility of the clays which contain them. Their use as stabilizers entails a number of difficulties of which the main one results from their effect often being reversible. They can in fact be

● **Bull's blood**

● **Sisal**

The concentrated extract of sisal fibres is used in Mexico.

● **Termite mounds**

Termite mounds are remarkably resistant to unfavourable weather conditions. This is probably due to a secretion the active ingredient of which is a non-ionic polymer of the polysaccharide cellulose type. Earth from termite hills is sometimes used to make renders.

Industrial products

washed out when the treated material is exposed to moving water. Moreover, they produce efflorescences. Their main beneficial effect is to reduce the affinity of clay particles for water.

- Chlorides: - sodium: flocculant
- calcium: less effective than sodium chloride
- dialkyl dimethylammonia chloride
- ferric
- Calcium sulphate : (or gypsum) to be used cautiously.
- Aluminium salts: these are electrolytes and bring about electrochemical stabilization.

● **Silicates**

Calcium, potassium and sodium. The effect of sodium silicate is referred to in the paragraph on "Main physico-chemical stabilizers".

Certain industrial waste products can be ideally suited to stabilization. The fact that they are waste products sometimes posing major head-aches for the industrialists who have to get rid of them does not, however, necessarily make them economically viable.

- Sump oil: this is gradually washed out by rain and its action is not durable.
- Blast furnace slag: can be effective or have no effect at all depending on its composition.
- Lignin: by-product of the wood industry, this is water-soluble. It can be mixed with certain chrome salts to render it insoluble. Chromolignin is unfortunately extremely expensive to obtain.
- Molasses: wood molasses (cf. lignin) sugar or lime sucrose.

Commercial stabilizers

Listed below are commercially available stabilizers. These are not the miracle products they may be thought to be. On the contrary they often give poor results and their effectiveness should be checked out by the user, without paying too much heed to the commercial distributors' claims. Nearly all these stabilizers are based on commercially available industrial products which act in fairly predictable ways. For

example: a stabilizer containing 90% sulfuric acid is described as "a water-soluble liquid catalyst, resulting in ion exchange". Without rejecting them out of hand, these products should be approached warily. Some are effective, even very effective, in precise applications. Their prices are carefully calculated to keep them comparable with those of conventional stabilizers.

Product or process	Base	Dosage	Comments
ADOGEN 442	quaternary amine	0.15 to 2%	
ALIQUAD H 226	quaternary amine	0.15 to 2%	
AM 9	polyacrylamide		fairly toxic
ARMEEM	polymer detergent		
ARQUAD 2 HT	dialkyl-dimethylammonia chloride		
	polymer detergent derived from quaternary amine		
CONSERVEX	cut-back and quaternary amine	0.5 to 1%	water-proofing to be used with CONSOLID SC 444
SCX 444			compaction aid to be used with CONSERVEX SCX 444
CONSOLID SC 444	wax and polymer detergent	0.05	
CRETASOL	quaternary amine on lime filler	idem STABIRAM	compaction aid
EARTH-PAK			sold with production unit
LATOREX	laterite and lime		other commercial name of RRP
LANDSCAPE			
MITSUI	polyurethane		
STOPPER			
NSP 121	natural water repellent resin		
NSP 252	natural water repellent resin		
NVX	natural water repellent resin		
PACZYME			compaction aid
PLASMOFLAT			
PLASTIC B	lignosulphate and cut-back		binding and water-proofing agent
RESINE 321	colophone derivative		
RRP	sulfuric acid and sulphonated hydrocarbons		compaction aid
STABILONIA	heavy amine acetate	0.2%	similar to STABIRAM 6775
STABINOL	80% Portland cement 20% resin		binding agent and water repellent
STABIRAM 6775	heavy amine acetate	0.2 to 1%	cf. STABILONIA
STASOL	acid and electrolyte		2 products to be used one after the other A - liquid B - water-soluble solid
TACSS	polyurethane		
TERBEC	4-Tert-butylpyrocatechol		waterproofing
TERRABIND A&B	abietic lignosulphate resin		ditto Resin 321. Aluminium sulphate has to be added.
TERRABIND C			binding agent
TERRABIND D	quaternary amine		



CRA Terre

FIGURE 291: TIMBER-FRAME BUILDING: BAYLEAF FARMHOUSE, 16TH CENTURY (SINGLETON OPEN AIR MUSEUM, ENGLAND).

8. COMBINED TECHNIQUES

Under this heading we consider all the ways of building in which earth is used in combination with structural elements (framework) in wood or some other strong material (reed, steel, reinforced concrete etc.) There are many variations on this theme, depending on whether the framework is the key element of the structure or merely a reinforcement. They can be classified into three broad groups:

- The framework supports all the building loads on its own and earth is used only as an infill between the load-bearing elements of the half-timbering. This is the case with the timber-frame houses found, for example, in Alsace and Normandy (France).

- The framework and the earth share the load. The framework elements, which are lighter than for timber-frame buildings, bear only the compressive load and lend rigidity to the whole. The framework can be within the thickness of the wall or take the form of the two outer layers of an earth wall "sandwich".

- The elements' main role is to provide bending strength: flooring, lintels, wood-reinforced flooring or roofing blocks etc.

**Timber-frame
(fig. 291)**

In this building method earth serves only to protect the building against the cold and bad weather and it is the carpenter who is the key figure in the construction work. Our concern here is not with techniques of half-timbering (the overall structure of posts) which would in themselves deserve a completely separate book.

The infill material, known in French as "torchis", is a mixture of earth and vegetable fibres or animal hairs, applied in a plastic state to a thin wooden lattice (fig. 295). Generally the earth infill does not cover up the framework elements, so walls remain fairly thin and the building very light.

CRATerre

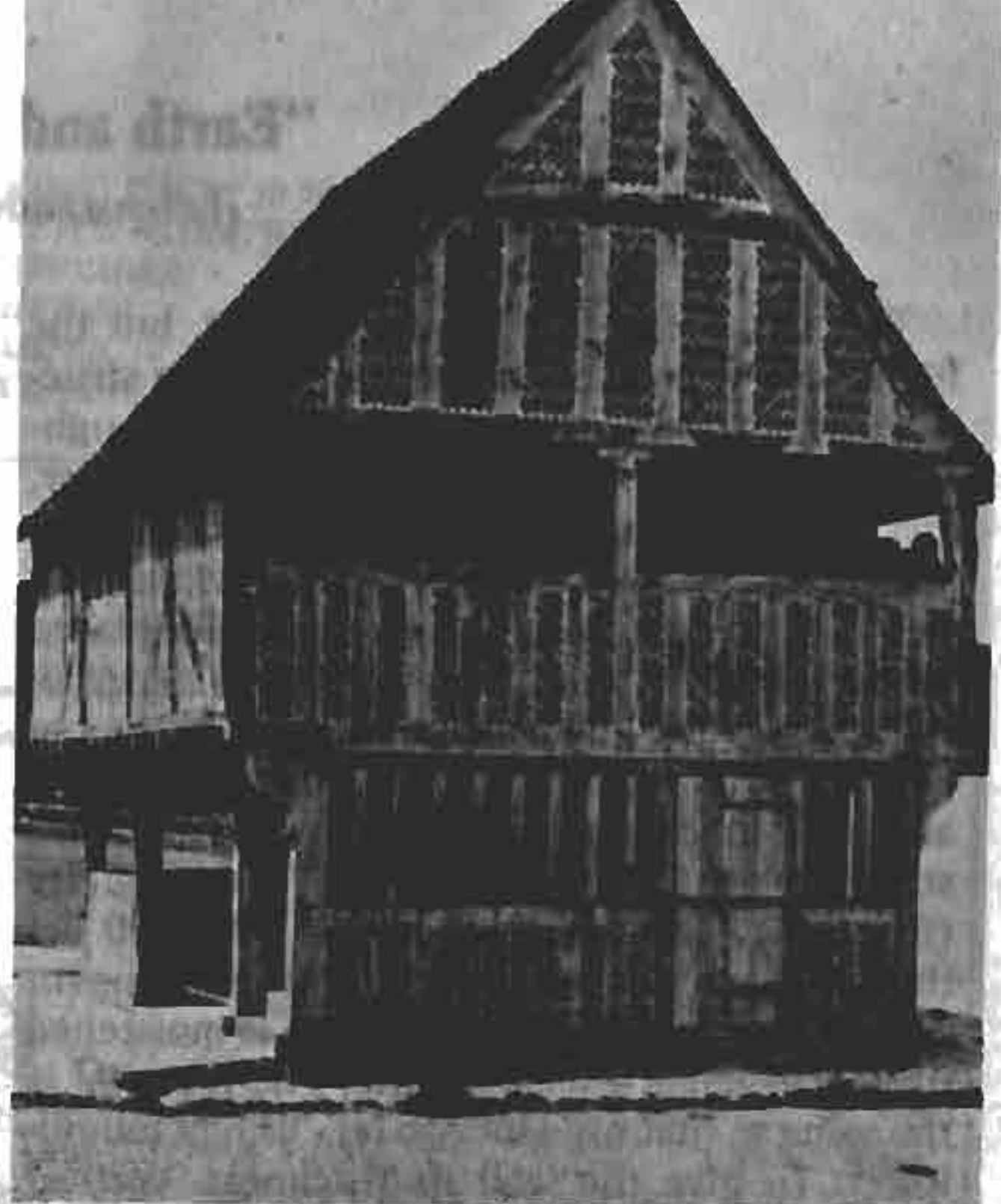

▲ **FIGURE 292:**
TITCHFIELD MARKET HALL,
16TH CENTURY (SINGLETON
OPEN AIR MUSEUM, ENGLAND).

◀ **FIGURE 295:**
DAUBING
A STRUCTURE
OF POSTS
AND
TRANSVERSE
POLES
(GUATEMALA)

► **FIGURE 293:**
CATHERINGTON TREAD
WHEEL,
17TH CENTURY
(SINGLETON OPEN AIR
MUSEUM, ENGLAND).
THIS LITTLE HOUSE
SHELTERS A WHEEL
WHICH MAY HAVE
BEEN DRIVEN BY A
MAN WALKING INSIDE IT
TO RAISE WATER FROM A WELL.
THE INFILL HAS NEVER BEEN
PLASTERED, WHICH WAS NOT
UNCOMMON AT THE TIME.

CRATerre



"Earth and post" building

(Lehmständerbau) - ref. 23

This is a variant on timber-framing, but the framework is kept to a minimum, i.e. the structure consists only in wooden posts either rough-cut or squared to 10 to 15 cm in diameter, placed approximately every 1.5 m down the middle of the wall. These posts are sometimes dug into the ground, but more usually placed on a footing to avoid them rotting. A series of wall-plates links them at the base and at the top and serves as the ring and tie beam. The posts are wind-braced only at the corners and the structure needs the earth infill to lend it rigidity (fig. 296). The walls, which are 40 to 50 cm thick, are made of a mix of equal proportions (in volume) of earth and straw, which is moistened until it reaches a plastic state. The material is the same as that used for cob (cf. "Direct moulding"). To give the wall its thickness, vertical wooden frames are placed to mark the inner and outer limits of the wall and it is to this that the shuttering, consisting in two simple panels, is attached. They will be removed once the building is complete. In some cases the marking frames serve as the structure of the wall instead of posts. In this event they are made of two half-posts of round wood, flat surface facing outwards, linked by two or three cross-pieces.

The shuttering is filled with an earth mix which is pushed into place with a small fork and lightly pressed down with a wooden tamper. From time to time thin wooden sticks are inserted as horizontal reinforcement. Once the wall is complete, the material is so "elastic" that no shrinkage cracks appear.

FIGURE 296: "EARTH AND POST" BUILDING.
- SHOWING THE ROUGH-CUT VERTICAL WOODEN POSTS SERVING AS REINFORCEMENT AND THE MARKING FRAMES TO WHICH THE SHUTTERING IS ATTACHED AND WHICH WILL BE REMOVED ONCE THE WALL IS COMPLETE.

- THE SPACING STICK MAINTAINS THE CORRECT DISTANCE BETWEEN THE TWO SHUTTERING PANELS.

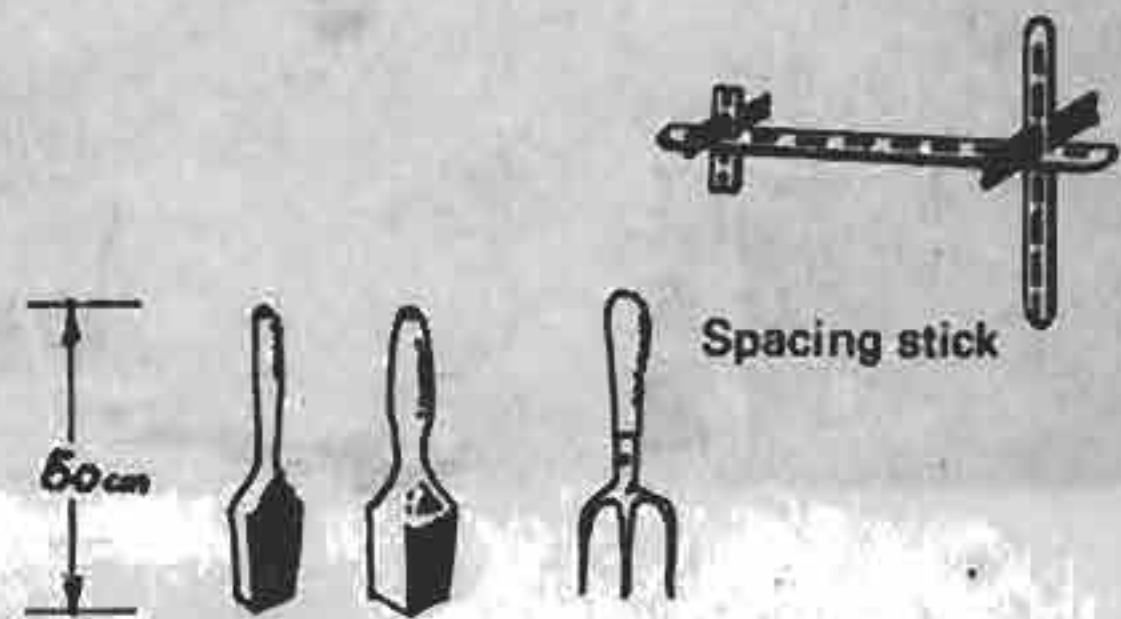
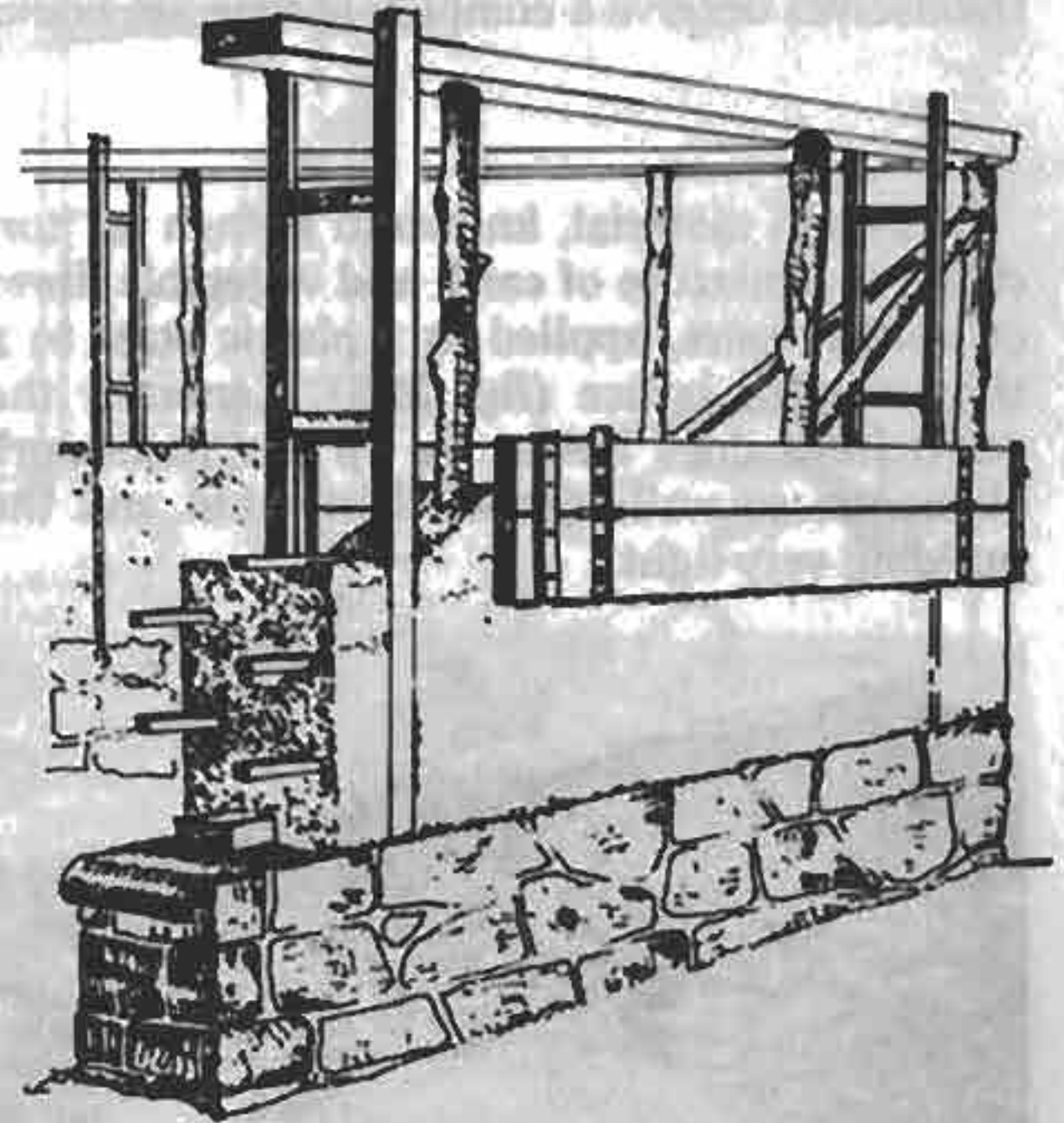

Horizontal elements

All the following techniques use earth mixes with a high proportion of straw. This gives the earth additional strength and enables it to be used for elements subject to bending stress.

FLOORING (fig. 298) - ref. 16

Once the floor joists have been laid, they are linked by a number of small sticks placed across them at 8 to 10 cm intervals.

A supporting work-bench measuring 1 x 0.8 m

is fitted under the joists and held in place with a prop. This work-bench is kept permanently damp during the work. The plastic earth is shaped on the work-bench into long flat pieces, which are then pressed with a stick between the lattice work in such a way as to completely envelope each stick. The builder works from above kneeling on a plank and with a small rammer tamps the earth firmly above and below the lattice in order to obtain a smooth surface for the ceiling. As each 70 cm section finished, the supporting work-bench is moved along.

FIGURE 297: "EARTH AND POST" BUILDING.

- 1 - THE STRAW AND OTHER FIBRES ARE CUT INTO PIECES 10 TO 15 CM IN LENGTH.
- 2 - THE "LIQUID" EARTH IS PREPARED, READY FOR MIXING WITH THE FIBRES.
- 3 - THE EARTH IS Poured WITH A MANURE-SPREADER.
- 4 - THE SHUTTERING IS FILLED WITH THE MIXTURE.
- 5 - WHICH IS COMPACTED WITH A LITTLE TAMPER.
- 6 - HORIZONTAL STICKS SERVE AS REINFORCEMENT.



Fauth

FIGURE 298: INFILLING
EARTH AND
WOOD FLOOR



Fauth

PREFABRICATED ELEMENTS

Experiments with prefabricated elements made in the German Democratic Republic after the war (ref. 23) focused on three types of elements:

- tongue and groove partition panels measuring 100×25 cm;
- door and window lintels of up to 1.2 m wide;
- reinforced flooring or roofing blocks (fig. 299).

The earth (leicht lehm) is mixed with 50 to 70 kg of straw per cubic metre of sufficiently wet earth, then moulded on a special work-bench fitted with a heavy lifting cover-plate which presses the earth into the mould, thus achieving slight compaction. All the prefabricated elements are generally reinforced with wooden sticks. Once finished they have the following characteristics and their particularly low density makes them very good thermal insulators.

thickness (cm)	volume of loose earth per m^2 (m^3)	weight of fibre per m^2 (kg)	weight of element per m^2 (kg)	density
6	0.03	3 to 4	48	0.8
10	0.05	5 to 7	80	0.8
14	0.07	7 to 10	112	0.8
18	0.09	9 to 12.5	114	0.63

The reinforced flooring blocks generally measure $70 \times 32 \times 11$ cm. They are reinforced by two pieces of wood 3 cm in diameter which are prepared by soaking in water or mud and coating them in a 4 cm layer of earth and fibres. They are then placed in the moulds when these are ready to be filled. The bending strength of such a reinforced block, tested in March 1950 at Magdebourg, was shown to be a total of 450 kg (fig. 300). (p. 217).

FIGURE 299: PREFABRICATED "LEICHT LEHM" ELEMENTS (i.e. OF EARTH MIXED WITH A HIGH PROPORTION STRAW).

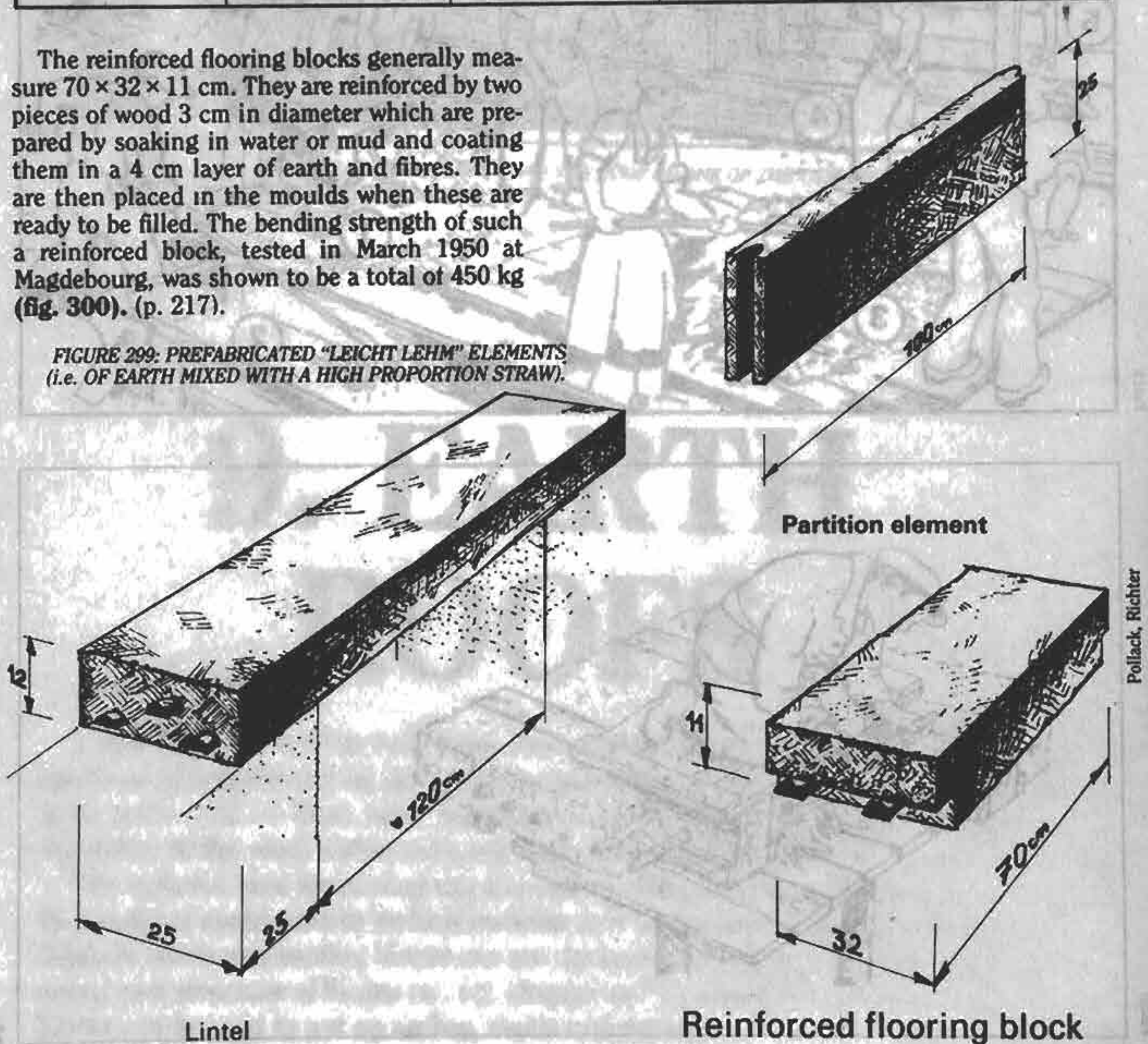

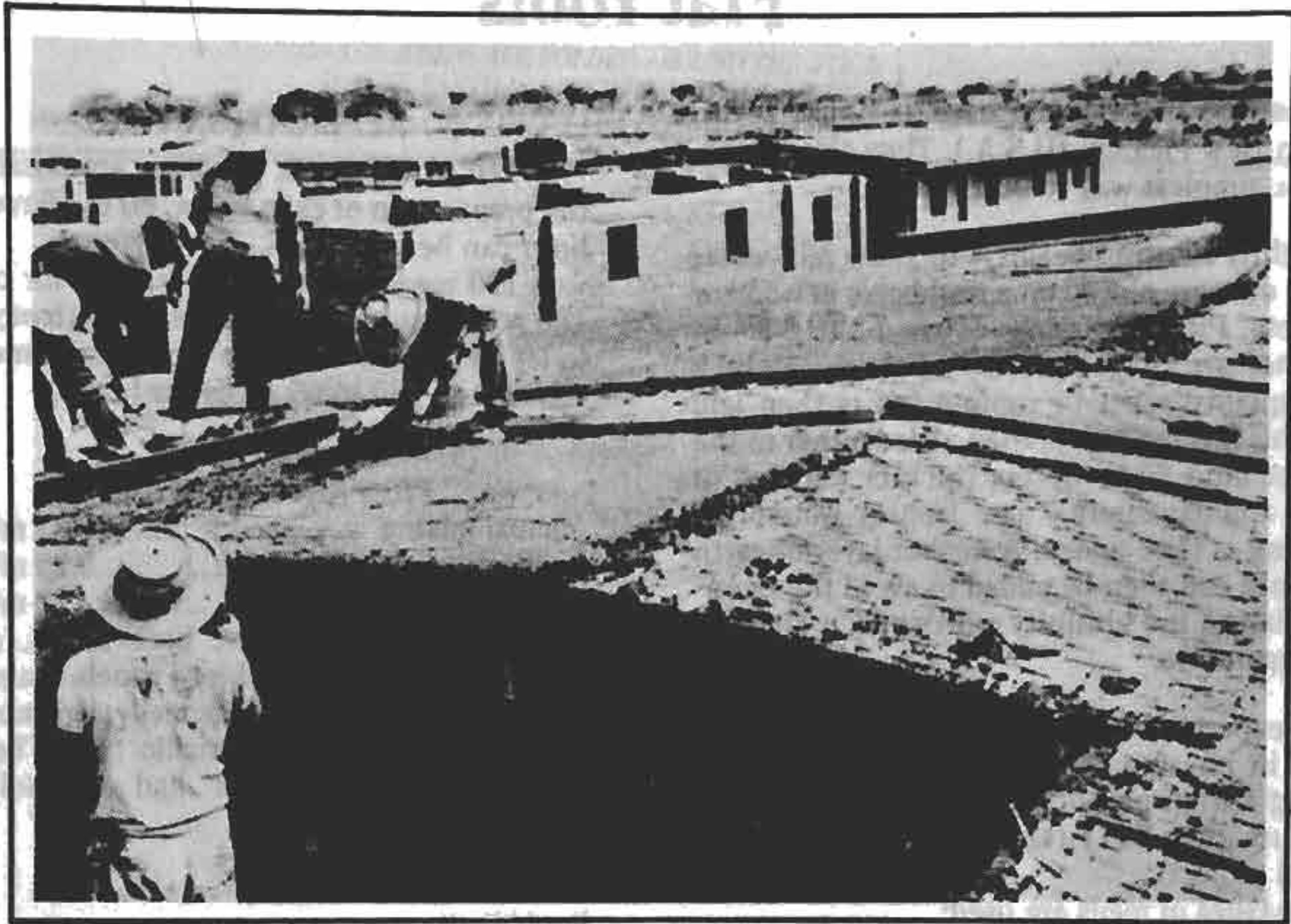

FIGURE 301: POURING STABILIZED EARTH ONTO THE ROOF OF ONE OF THE CAYALTI HOUSES (PERU); CF. CHAPTER ON "ABODE".

9. EARTH ROOFS

Earth has been used to build roofs since ancient times. The type of roofing used will clearly depend on the main function of the covering: protection from heat, from cold or from rain. Stabilization of the earth used improves the durability of the roofs whilst reducing their maintenance needs.

The material used for roofing can assume very different forms. The earth can be poured or compacted in its final position over a structure of wood, reeds etc. Slightly reinforced roofing blocks can also be made and supported by a conventional roof structure of beams etc. (cf. chapter on "Combined techniques"). Or bricks can be used to put up arches, vaults and domes.

Flat roofs

These are traditionally used as house coverings in New Mexico, (U.S.A.). They also represent the simplest way to build a roof.

Slightly slanting beams - to allow rain-water to run off - are placed on a ring-beam of wood or concrete. Planks or sticks of wood 3 to 6 cm in diameter are placed on top of these. A thick good quality paper or roofing felt is then laid over this layer. Earth is then added either in the form of mud 20 to 30 cm thick or rammed in layers approximately 7 cm deep. A waterproof covering is then added. A further layer of earth or stones can then be added to avoid the covering dilating too abruptly with sudden changes in temperature.

An experimental system tried in Peru consisted in pouring asphalt-stabilized earth containing a high proportion of fibres over a reed structure (fig. 301) (see chapter on "Adobe": Cayalti project).

Two types of reeds are used:

- **cãna brava** (full reed) 2 cm in diameter in 4 m lengths, used whole with 11 units per m²;
- **carrizo** (hollow reed) 2 cm in diameter in 4 m lengths split in two lengthways with 7 units per m².

Various fibres were tested to reinforce the earth. In order of preference these included sugar cane waste, dry grass (gramma china cynodon dactylon) and rice husks. These fibres were added by hand in a proportion of 60% by volume.

The reeds were impregnated with a bitumen solution and then nailed to a wooden roof structure, the nails being placed as close as possible to the reed nodes to avoid splitting them. Staples and metal ties do not give good results. The earth - clayey sand at 75% sand - was stabilized with 2% bitumen (RC 250). The bitumen is first mixed with the soil, then the fibres are added and the mix is spread over the reeds in a layer 3 cm thick leveled with a straightedge.

APPLICATION TIME

● 110 to 130 reeds per hour are possible for the preparation of cana brava, 60 to 65 reeds per hour can be laid;

● 110 reeds per hour are feasible for carrizo, 180 reeds per hour can be split lengthways, and to lay them takes a similar amount of time as for cana brava, (60 to 65 reeds per hour).

PREPARING THE EARTH

Manual mixing	0.33 m ³ /hour
Application	0.25 m ³ /hour
Smoothing and leveling	12 m ³ /hour

Another system to have been tested, also in Peru*, used prefabricated reed panels coated with cement-stabilized earth. The reeds were more supple and lighter, of the Caricillo type. The earth intended for compaction had the following characteristics:

liquid limit	23.9%
plastic limit	20.8%
plasticity index	3.1%

This is therefore a sandy soil, very little plastic. The panels are prefabricated in a 1 x 1 m frame placed on the ground:

- a 2.5 cm layer of earth stabilized with 15% cement is spread in it;
- the previously flattened reeds are placed on top of this layer forming a grill;
- these are covered over with earth, filling the frame, and tamping the whole with a 10 kg tamp in 5 passes; the compaction achieved being equivalent to 90% of the Proctor test.
- after 7 days' curing the panels are ready for use.

The panel dimensions are 100 x 100 x 6.3 cm and they weigh 111 kg each.

As far as their bending strength is concerned, they can resist loads of 372 kg spread over their entire surface, the reeds representing 0.67% of the weight of the finished panel.

*See chapter on "Adobe", Lima project.

Clay-bonded thatch panels (fig. 302)

226 These are large pre-fabricated thatch panels bonded with earth which are traditionally used in Germany. They generally measure 90 x 60 cm

and are produced on a work-bench.

An experiment was attempted in 1950 in Saxe with a view to making thatch panels larger than

FIGURE 302: PRODUCTION OF LARGE CLAY-BONDED THATCH PANELS

A - FRAME

B - LAYING THE STRAW IN THREE LAYERS

C - THE HEADS ARE FOLDED AROUND THE STICK

D - THE EARTH IS SMOOTHED WITH A SPADE

E - LAYING THE PANELS

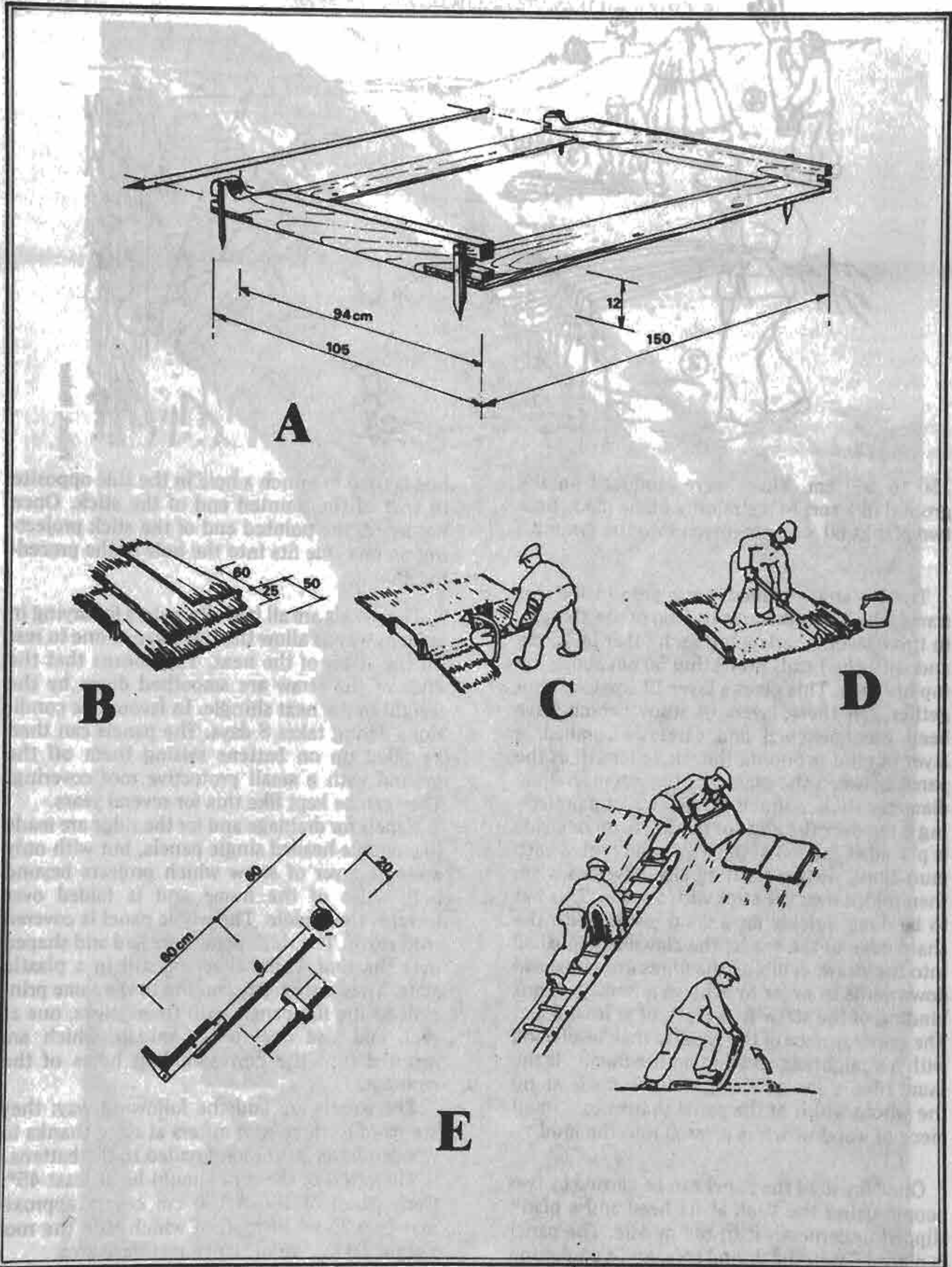
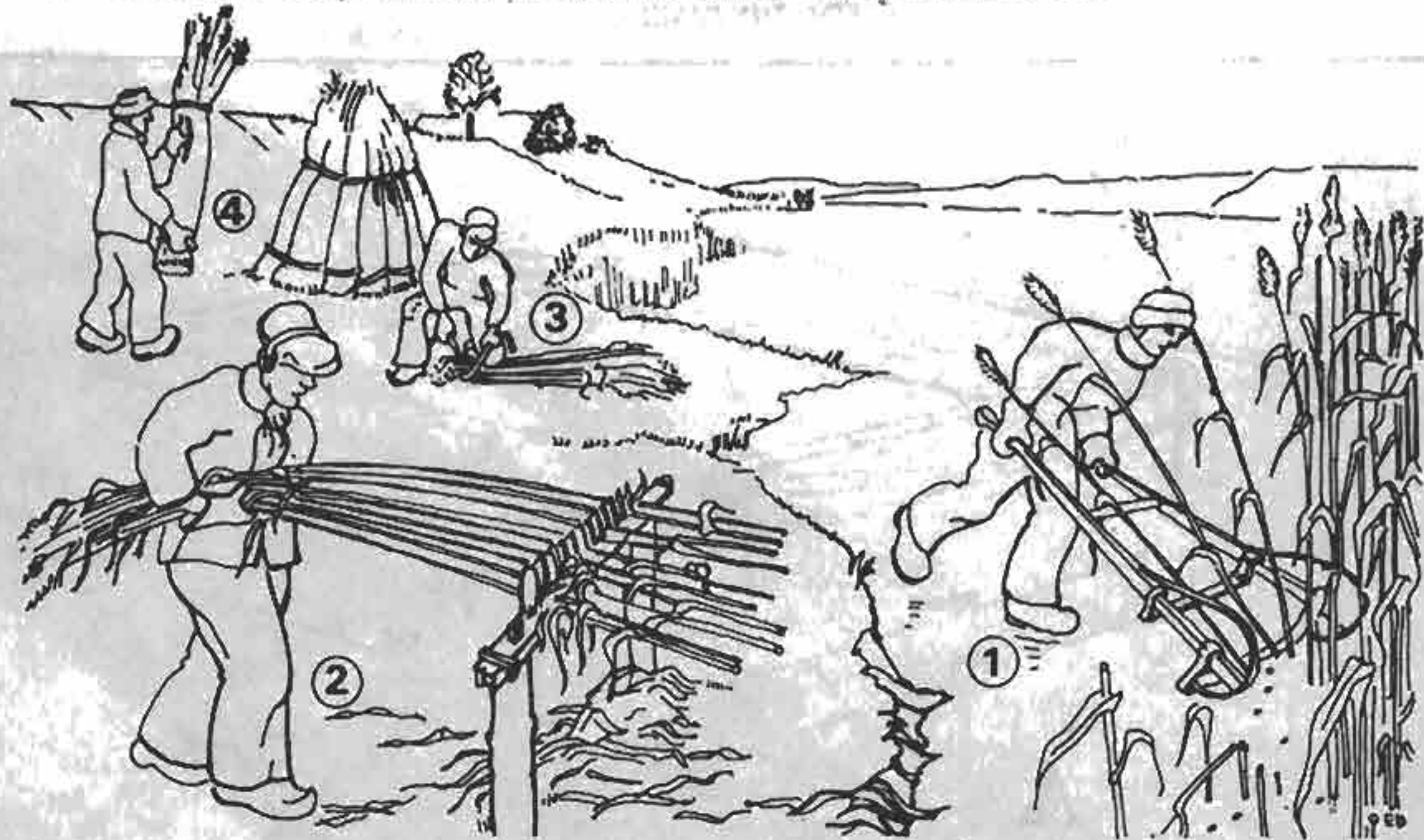

FIGURE 303: HARVESTUBG REEDS FOR CLAY-BONDED THATCH PANELS, GERMANY

- 1 - THE REEDS ARE CUT AS CLOSE TO THE ICE AS POSSIBLE
2 - A SPECIAL COMB IS USED TO REMOVE THEIR LEAVES
3 - THE REEDS ARE TIED INTO SHEAVES
4 - AND COLLECTED INTO STOOKS



Pollack, Richter

150 to 160 cm. These were produced on the ground in a sort of restraining frame made from two planks 60×12 cm driven into the ground.

The rye straw or reeds are placed inside this frame, the heads towards the top of the shingle, in three layers overlapping each other by 25 cm and with the heads projecting 50 cm above the top of frame. This gives a layer 12 cm deep altogether. On these layers of straw, which have been pre-moistened and carefully combed, a layer of mud is poured the whole length of the panel between the planks of the frame. A 3 cm diameter stick, pointed at one end, and projecting 8 cm over the edge of the frame on one side is placed at the top of the frame and coated with mud along with everything else. The heads are then folded over the stick with a spade. This has to be done quickly for a good result. With the sharp edge of the spade, the clay mix is pushed into the straw, combing the fibres from the head downwards in order to achieve a homogeneous binding of the straw to a depth of at least 5 cm. The upper surface of the panel is then leveled off with a straightedge resting on the frame. At the same time a sort of fixing hook is made along the whole width of the panel thanks to a small piece of wood which is pressed into the mud.

Once finished the panel can be carried by two people using the stick at its head and a plank slipped underneath it in the middle. The panel is placed flat in the drying area, and a gardening

hoe is used to punch a hole in the side opposite to that of the pointed end of the stick. Once hardened, the pointed end of the stick projecting on one side fits into the hole of the preceding shingle.

The panels are all laid alternately for drying in such a way as allow the clay head of one to rest on the straw of the next. This means that the ends of the straw are smoothed down by the weight of the next shingle. In favourable conditions drying takes 8 days. The panels can then be piled up on battens raising them off the ground with a small protective roof covering. They can be kept like this for several years.

Panels for drainage and for the ridge are made like double-headed single panels, but with only a single layer of straw which projects beyond both sides of the frame and is folded over towards the middle. The whole panel is covered with earth. The ridge panels are laid and shaped over the roof whilst they are still in a plastic state. They are fixed according to the same principle as the flat panels with three sticks, one at each end and one in the middle which are inserted into the corresponding holes of the next panel.

The panels are laid the following way: they are fixed to three roof rafters at once thanks to wooden laths 20 cm long nailed to the battens.

The pitch of the roof should be at least 45° . Each panel of 150×150 cm covers approximately 0.75 m^2 of roof, in which case the roof weighs 50 kg/m^2 of slanting surface area.

Mud brick vaults

Vaults and domes are very common in Iran and the Middle East. In Egypt the Ramasseum

granaries at Luxor (**fig. 304**) and the layered vaults of the St. Simeon monastery at Aswan tes-

FIGURE 304: RAMASSEUM GRAIN-STORES AT THEBES (EGYPT)



tify to the mastery of this technique achieved centuries ago.

FIGURE 305: LAYERED VAULTS - ST. SIMEON MONASTERY (ASWAN, EGYPT).



CRATerre Bijan Rafii

The largest brick vault known to exist has a span of 27 m and a height of 38 m and is at Ctesiphon (Iraq).

The shape of the vault rise should be such that no brick is subject to any tensile stress. The ideal geometric curve is therefore that of an inverted chain held at each end and left to hang freely. The height to span ratio, which determines the volume of the vault, should not be too small in order not to subject the foundation at ground level to too much horizontal stress. A low rise vault will certainly provide a large habitable area with little material, but the bricks will be subject to a great deal of compressive stress causing considerable outward pressure at ground level.

Design principles

The span of vaults is limited in practice by the strength of bricks and above all by the ability of the soil at ground level to resist horizontal stress. Large spaces can, however, be covered by

building parallel arches laterally supported by buttresses. Small span vaults link these arches and therefore give a covered space of minimum weight.

Vault building with formwork

The simplest way to put up a vault is to use a form which supports the masonry during building. Although it is technically possible to support arches with a pile of bricks, the amount needed for a whole room would be too great to make this practicable. It is often easier to build a removable form. If it is not possible to build a form big enough for the whole room, a section 1

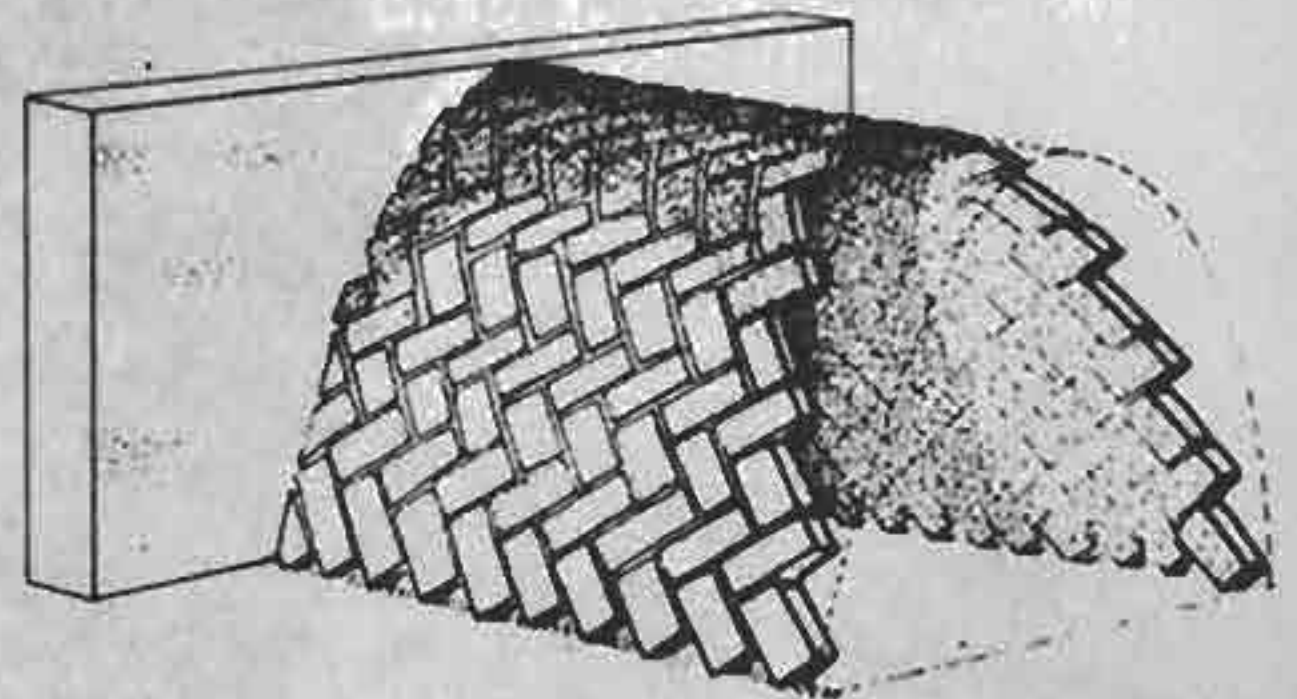

FIGURE 307: HERRING-BONE BONDING PATTERN

to 2 m long can be moved along as the vault is being built. This formwork can be metallic (fig. 306) or wooden. It should be light and easy to take down in order to be able to remove it once the room is completed. The form can be placed on wedges or on a cam system enabling it to be lowered a few centimetres prior to removal, relieving it of the weight of the vault.

The bricks are often laid in a herring-bone pattern (fig. 307) to enable better bonding with the following section of vault. Masonry laid in horizontal courses does not allow proper bonding between two succeeding sections of vault.

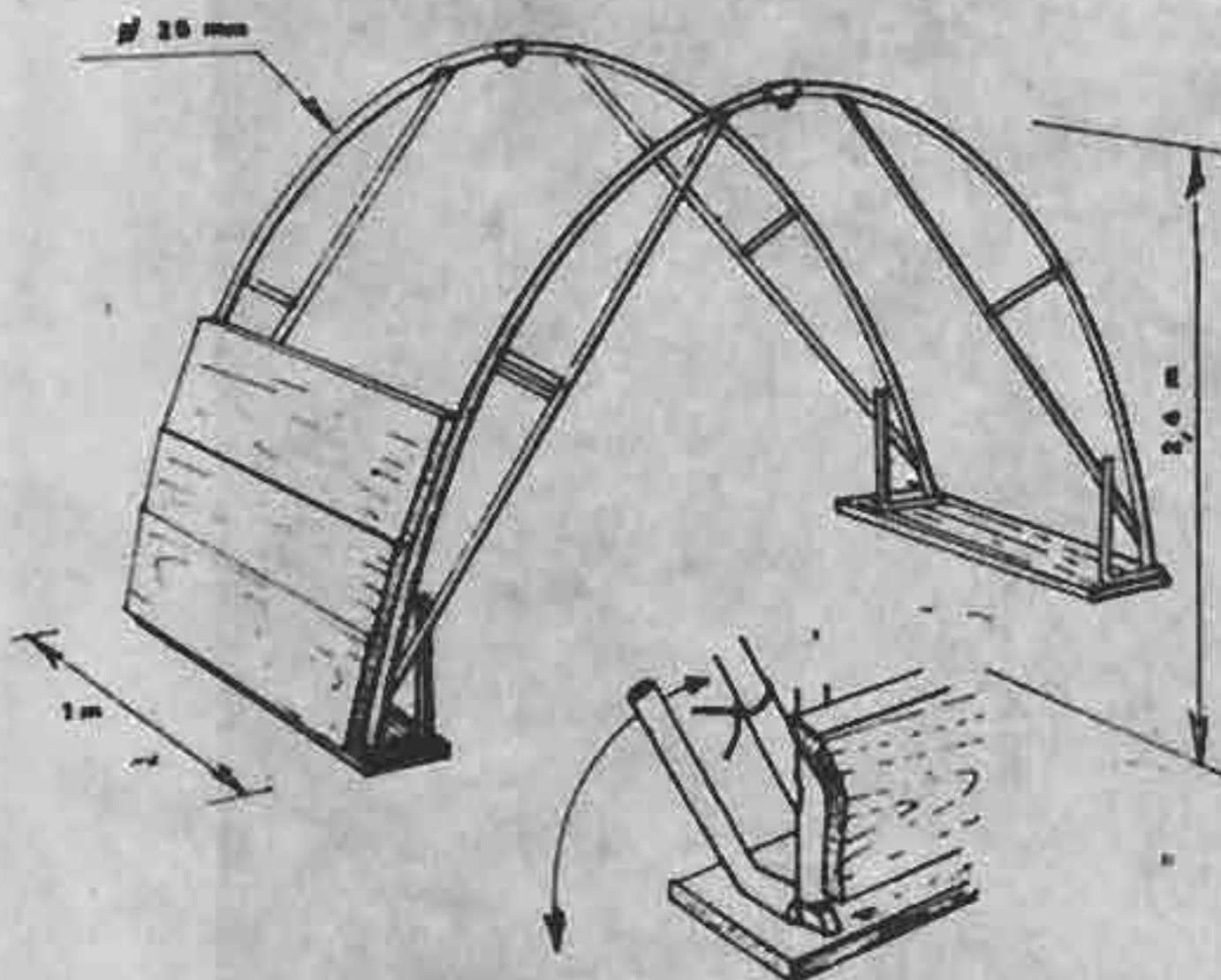

FIGURE 306: EXPERIMENTAL SHUTTERING WITH CAM TO FACILITATE REMOVAL

Vault building without formwork

The method of building vaults without formwork is very widespread in Iran and in the area formerly known as Nubia. It is thanks to the architect Hassan Fathy that this technique was revitalized in the course of his Gourna experiment in 1948. The Gourna project (opposite Luxor) in Egypt concerned a village of 7,000 inhabitants which was to have been entirely built in mud bricks with vault and dome roofs. The construction of vaults being unknown in this part of Egypt, Hassan Fathy recruited Nubian masons to teach the Gourna population this building technique (fig. 309-310).

FIGURE 309: CONSTRUCTION OF NUBIAN VAULT NEAR ASWAN (EGYPT)



Max et Suzanne Hirschi

FIGURE 310: THE MASON IS ABOUT TO "STICK" THE BRICK TO THE LAYER OF MORTAR. THE GROOVES MADE DURING MOULDING WHICH IMPROVE THE ADHERENCE OF THE BRICK TO THE MORTAR CAN BE MADE OUT ON ONE SIDE OF THE BRICK.



Max et Suzanne Hirschi

Wishing to experiment for ourselves with this technique, in 1977 we built a small section of vault at Vignieu (Isere, France). The vault has a span of 3 m and is 3 m high. It was made out of stabilized bricks compressed in a manual press (the "Palafitte", cf. chapter on "compressed earth bricks"). Adobe was not used, given that this would have demanded more drying time than we had at our disposal.

The building principle consists in raising the vault in steeply sloping courses (70° to 80° to the horizontal). Each brick is therefore leaning on the previous course and the clay mortar enables it to stick sufficiently to prevent its falling. The first course is built against a vertical wall on which is drawn the vault profile. Nubian master masons draw perfect parabolas by eye without using any measure or instrument. Lacking in their experience we built a collapsible template out of tubing which enabled us both to draw the profile of the inverted chain on the wall and to check it as the work progressed.

The first courses are laid "front-to-back" (on one side) (fig. 311) for greater strength and

FIGURE 311: LAYING THE FIRST BRICKS OF THE FOOTING



ADETEN

then "up-ended" (on one end) to lighten the building. The mortar was of cement-stabilized soil.

The standard brick produced by the press

FIGURE 312: THE BRICKS ARE LAID ON EDGE:
THE VAULT IS THEN 15 cm THICK.



ADETEN

(29 × 14 × 9 cm) was too heavy to hold simply by adherence to the mortar at the top the vault. We therefore had to build lighter bricks (4 cm less thick) so that the mortar sufficed to hold them in place (fig. 312).

The Nubians used special adobe bricks for vaults and domes, 5 cm thick and with a high proportion of straw, which made them particularly light. With their fingers they would make diagonal grooves on the wet bricks which improved the adhesion of the bricks to the mortar by suction.

Working in pairs, the Gournia masons built vaults of the same size as ours (3 m span) at a rate of 0.2 linear metres per hour (54 bricks). To achieve this rate of work the masons had two months' apprenticeship. Being totally lacking in experience, our own work progressed a great deal more slowly.

The main difficulty in the building process is to remain constant to the original shape as the work advances. There is a tendency as a result of the perspective of the builder to widen the "hips" of the vault and raise the height of the top. There is a risk of distorting the original shape and subjecting the bricks to tensile stresses.

Care must also be taken to maintain the same inclination of the bricks, whereas the builder tends to lessen their slant as he works up towards the top.

The vault ends naturally in a slanting section. The slant can be gradually eliminated if every 3 to 4 arches of bricks is allowed to dry.



ADETEN

ADETEN

FIGURE 313: THE BRICKS
AT THE APEX ARE
THE MOST TRICKY
TO LAY



FIGURE 314: THE BUILDER
ABOVE LEFT CHECKS
THAT THE SHAPE OF
THE VAULT REMAINS TRUE

Domes

Whereas the horizontal section of a vault will always be rectangular, that of a dome is circular. Domes can thus be easily adapted to round spa-

ces, but pose a problem when a dome is to be placed on a square or rectangular shape. There are various solutions to this problem (fig. 315).

FIGURE 315: THREE WAYS OF PUTTING A DOME ON A SQUARE ROOM PYRAMIDAL VAULT

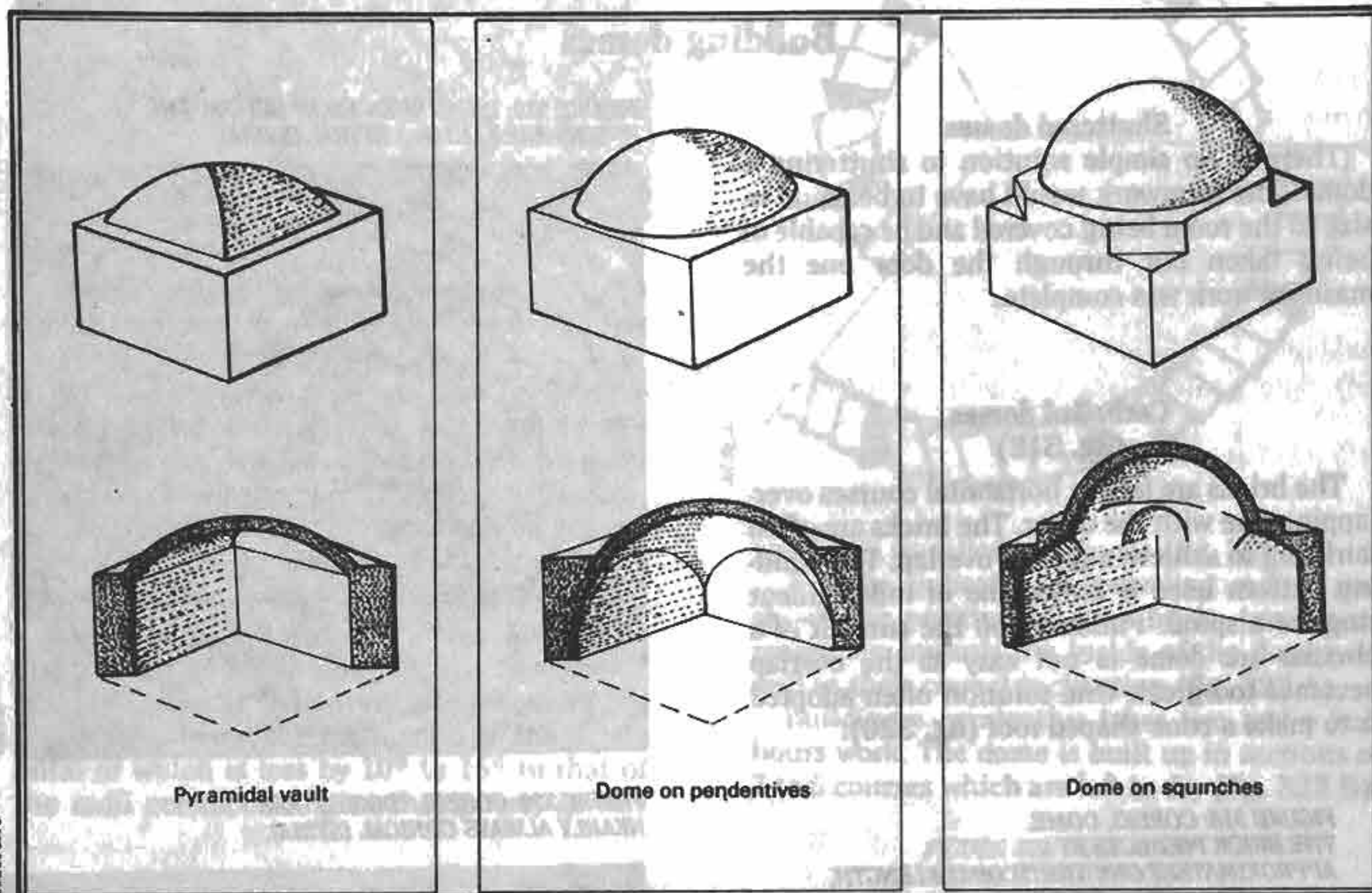

CRATerre

FIGURE 316: SQUINCHES IN THE DOME OF THE NEW GOURNA MOSQUE (EGYPT).

Pyramidal vault

The intersection of two vaults forms a “false dome” which resembles a pyramid with rounded sides. In a sense this is the opposite of the semi-circular vault since only the “inside” of the intersection is preserved. All the horizontal sections of this so-called “dome” are square.

Domes on squinches

The transition from a square to a circle is achieved via an octagon, by “cutting across” the corners of the square. This can be done in two different ways: using a beam made of some strong material or thanks to miniature vaults in the corners known as squinches which can take various shapes: cones, corbels etc. The dome rests on the octagon, its diameter being equal to the side of the square.



CRATerre

Domes on pendentives

In this case the dome is not a perfect hemisphere and its diameter is equal to the diagonal of the square. The construction begins in each corner with pendentives, kinds of spherical triangles which meet in the middle of the upper edge of walls.

The apex of the dome is below the level of the summit of the walls, at approximately 1 m from the ground for a room measuring 4 × 4 m. The arc is therefore flatter. This type of dome is thus lighter, but not standing completely free exerts horizontal pressure in the middle of the summit of the walls.

Building domes

Shuttered domes

There is no simple solution to shuttering a dome. The formwork would have to be equal in size to the room being covered and be capable of being taken out through the door once the masonry work was complete.

Corbelled domes (fig. 318)

The bricks are laid in horizontal courses overlapping one with the other. The bricks are often fairly big to achieve a greater overlap. The bonding pattern used is either one of independent rings or a spiral. Finishing off the summit of a circular arc dome is not easy as the overlap becomes too great. One solution often adopted is to make a cone shaped roof (fig. 320).

FIGURE 318: CORBEL DOME.
THE BRICK PROJECTS BY
APPROXIMATELY ONE TENTH OF ITS LENGTH.



FIGURE 319: DOME SEEN FROM BELOW, THE
BRICKS ARE LAID IN A SPIRAL (SYRIA).

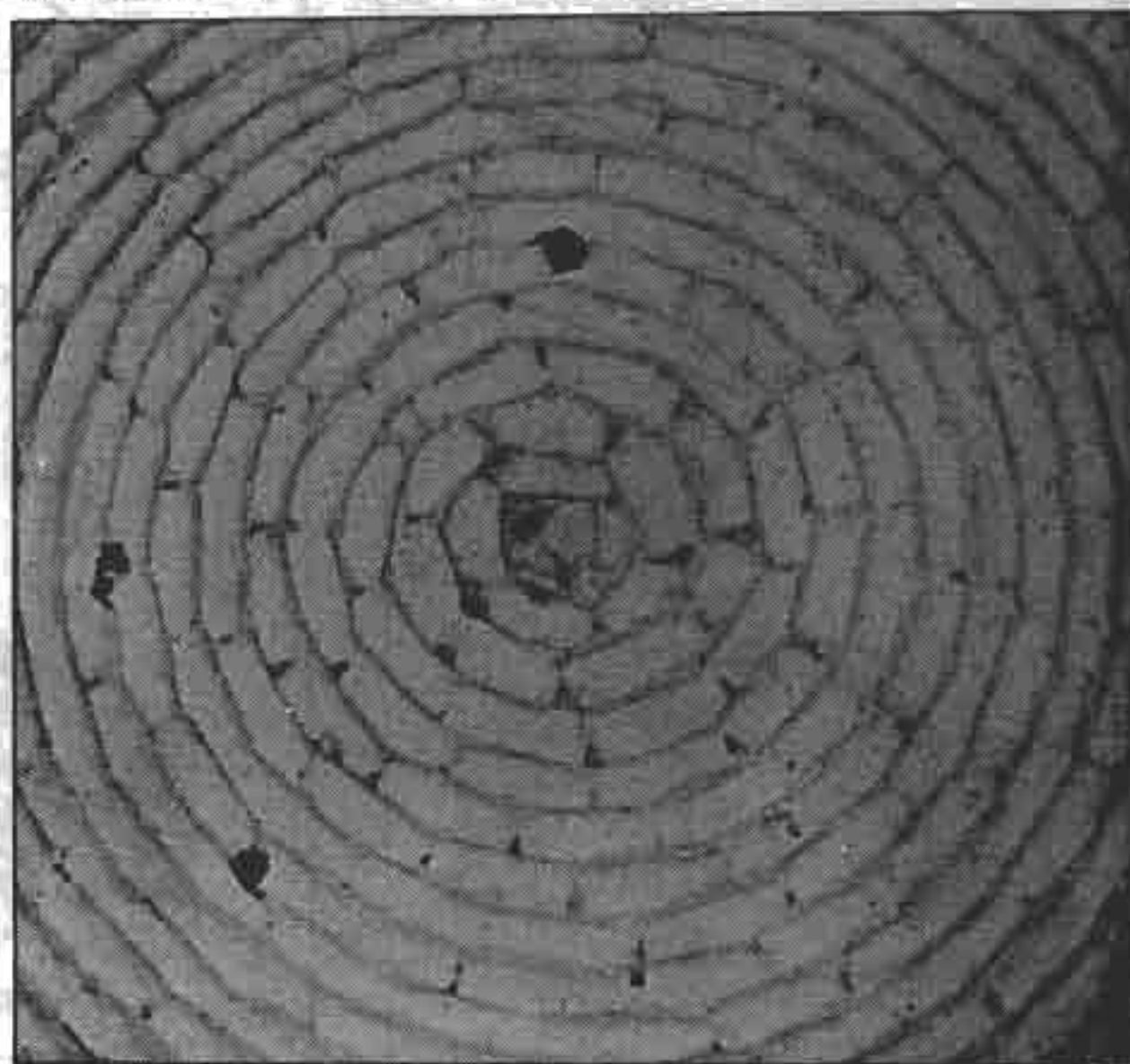

FIGURE 320: CORBEL "DOMES" ARE
NEARLY ALWAYS CONICAL (SYRIA).



Nubian dome
(fig. 321)

Using to the same principles as for building vaults, Nubian masons built domes without shuttering (experience of ADAUA in Mauritania).

Pendentives are built to achieve the transition from a square to the circular base of the dome.

FIGURE 321: DOME BUILT WITHOUT SHUTTERING IN NEW GOURNA (EGYPT)



CRA Terre

The pendentives and the dome form part of a sphere the diameter of which is equal to the diagonal of the square room being covered.

Rectangular bricks rather than in wedge-shaped or tapered elements are used for the building work which is achieved with no shuttering. To avoid the bricks slipping, the system used is based on a particular way of placing them. The same method is used for the construction of the pendentives and the dome.

Bricks are compacted with a press (Hydraulic Majomatic and S.M.) and measure $25 \times 15 \times 5$ cm. The bricks are laid in courses following the shape of a crown, the inclination to the horizontal of which is less by 10° to 15° to that of the radii corresponding to the sphere; in this

which causes the slippage is thus counteracted by the frictional force of the upper side and sides of the bricks. This orientation of the bricks must be compensated by trapezoidal elements used as

FIGURE 322 C

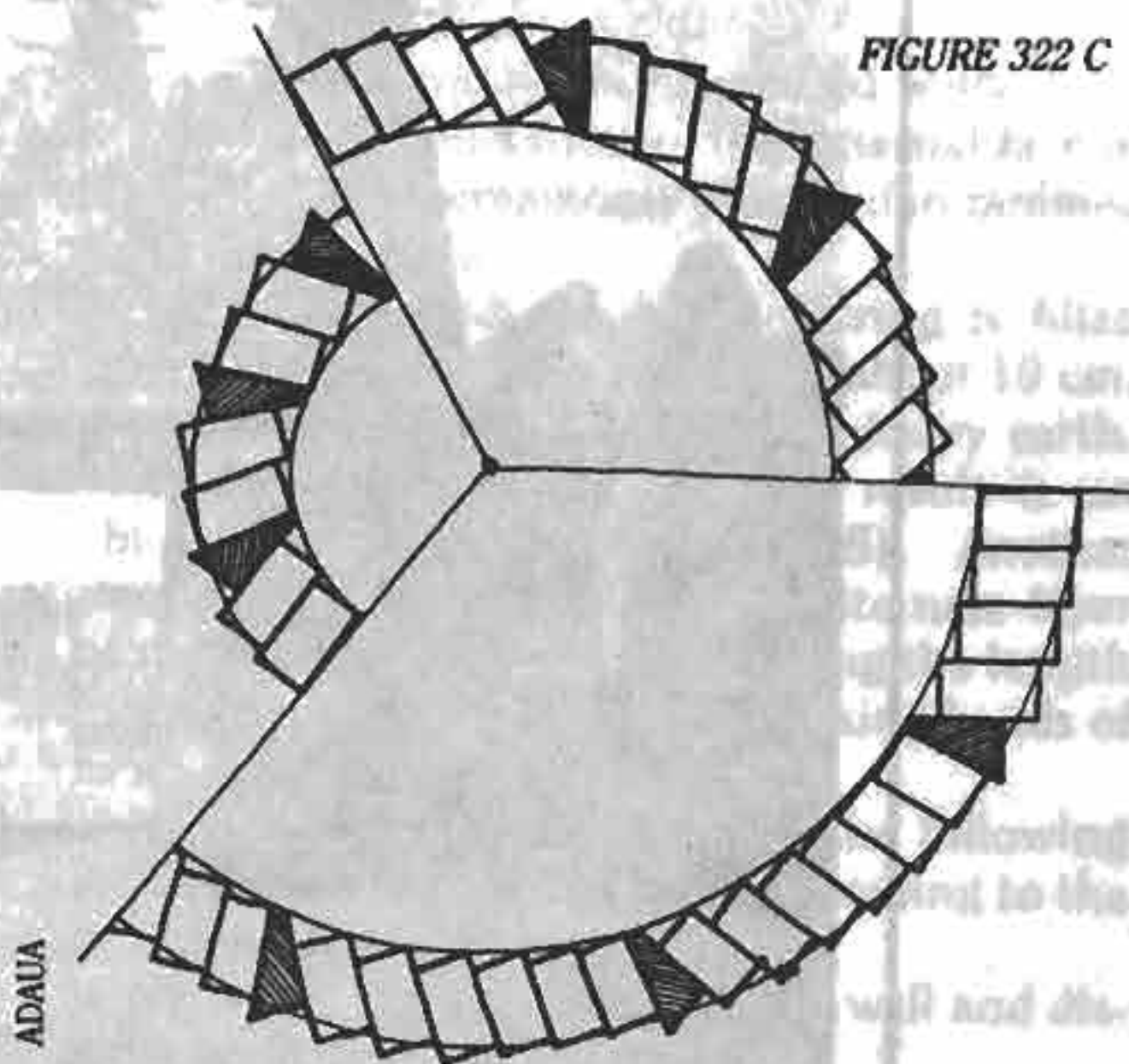

ADAUA

voussoirs: so-called key-stones (fig. 322 C).

A dome indicator or swiveling radius arm shows the position of each brick, (maximum projection towards the inside of the dome), as well as their correct inclination (fig. 323 A).

Building a pendentive takes two and a half hours work. The dome is built up in sections of 7 to 5 courses which are left to dry (fig. 323 B).

FIGURE 323: DOME CONSTRUCTION WITHOUT SHUTTERING

FIGURE 322: PRINCIPLE OF DOME CONSTRUCTION WITHOUT SHUTTERING

FIGURE 322 A

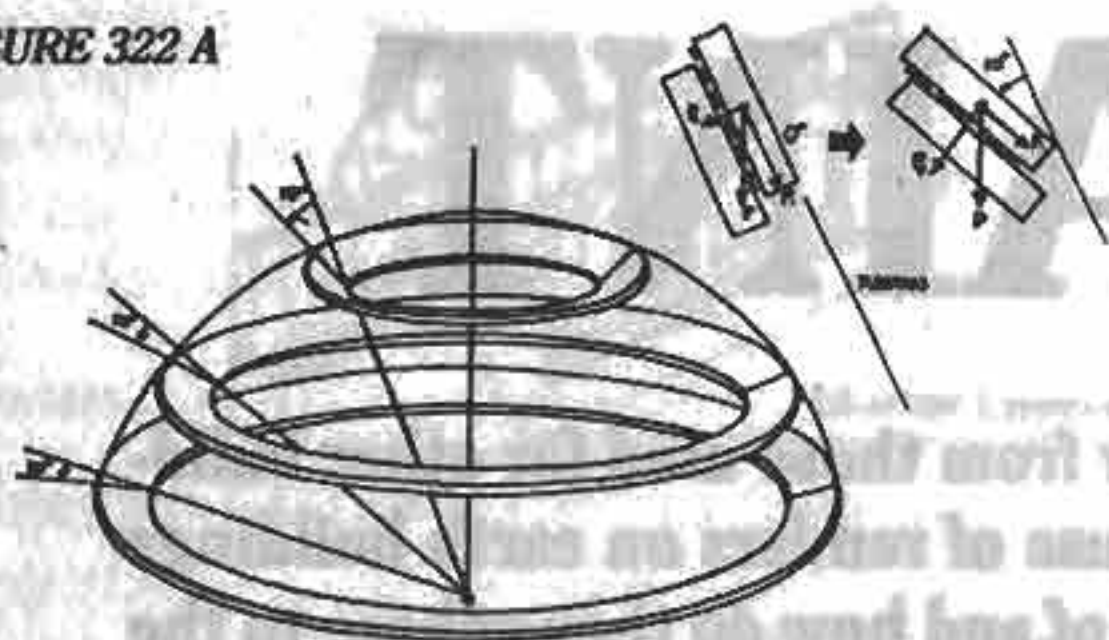

ADAUA

way the tendency of the bricks to slip is reduced (fig. 322 A).

In each course the bricks are slightly off center (10°) compared with the radii of the crown (fig. 322 B). The weight of the component (P)

FIGURE 322 B



ADAUA

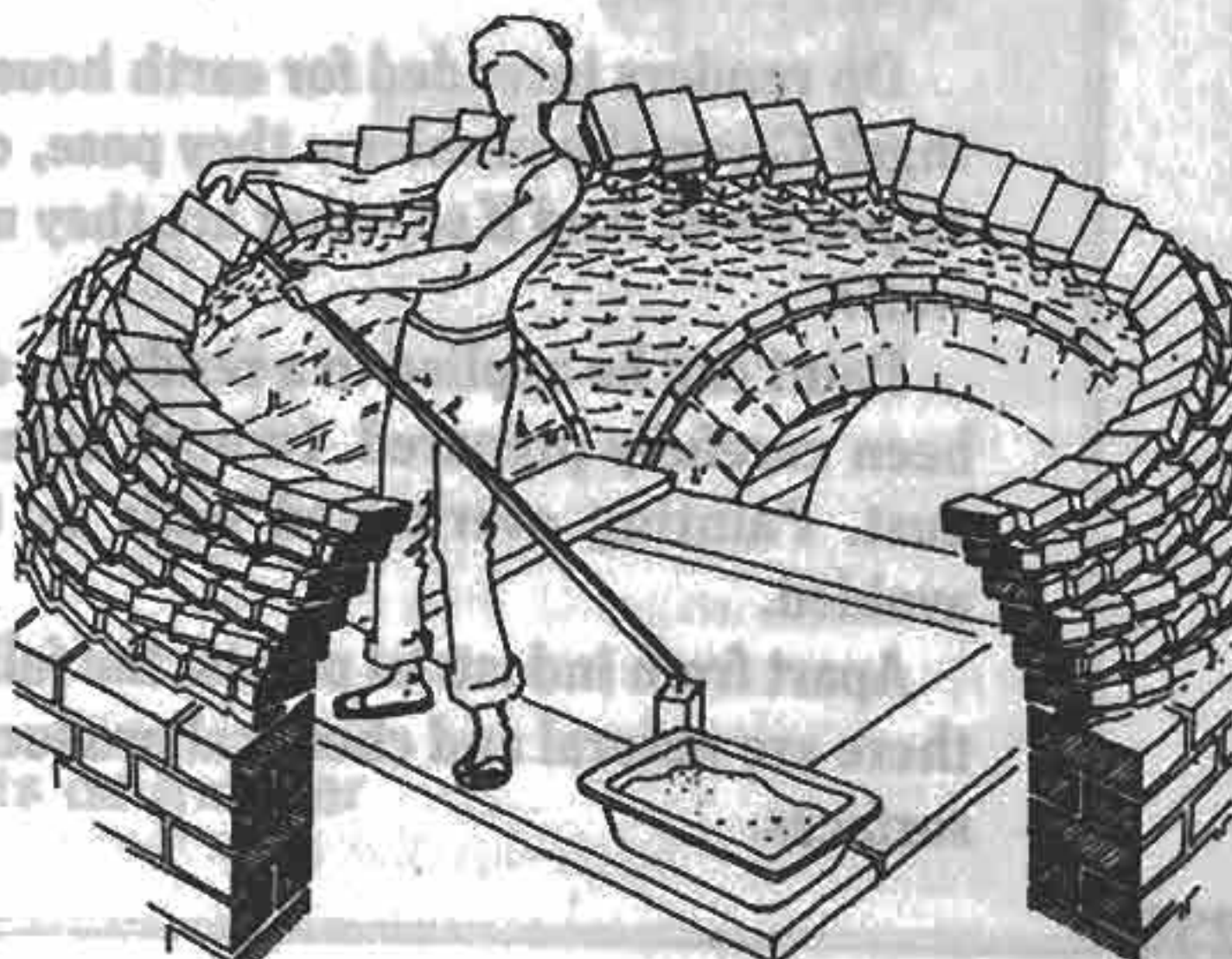
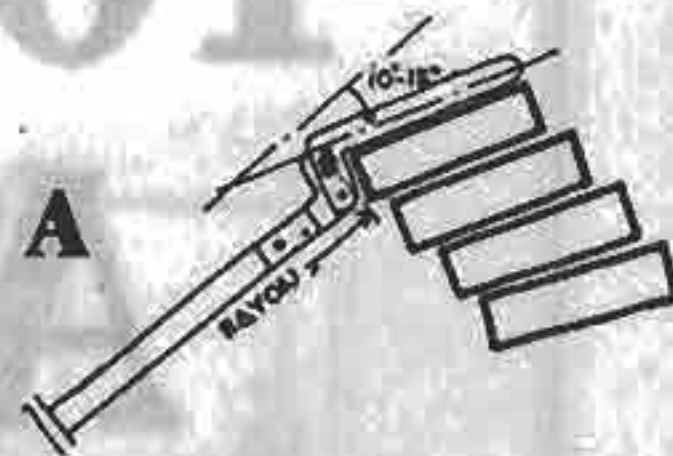

ADAUA

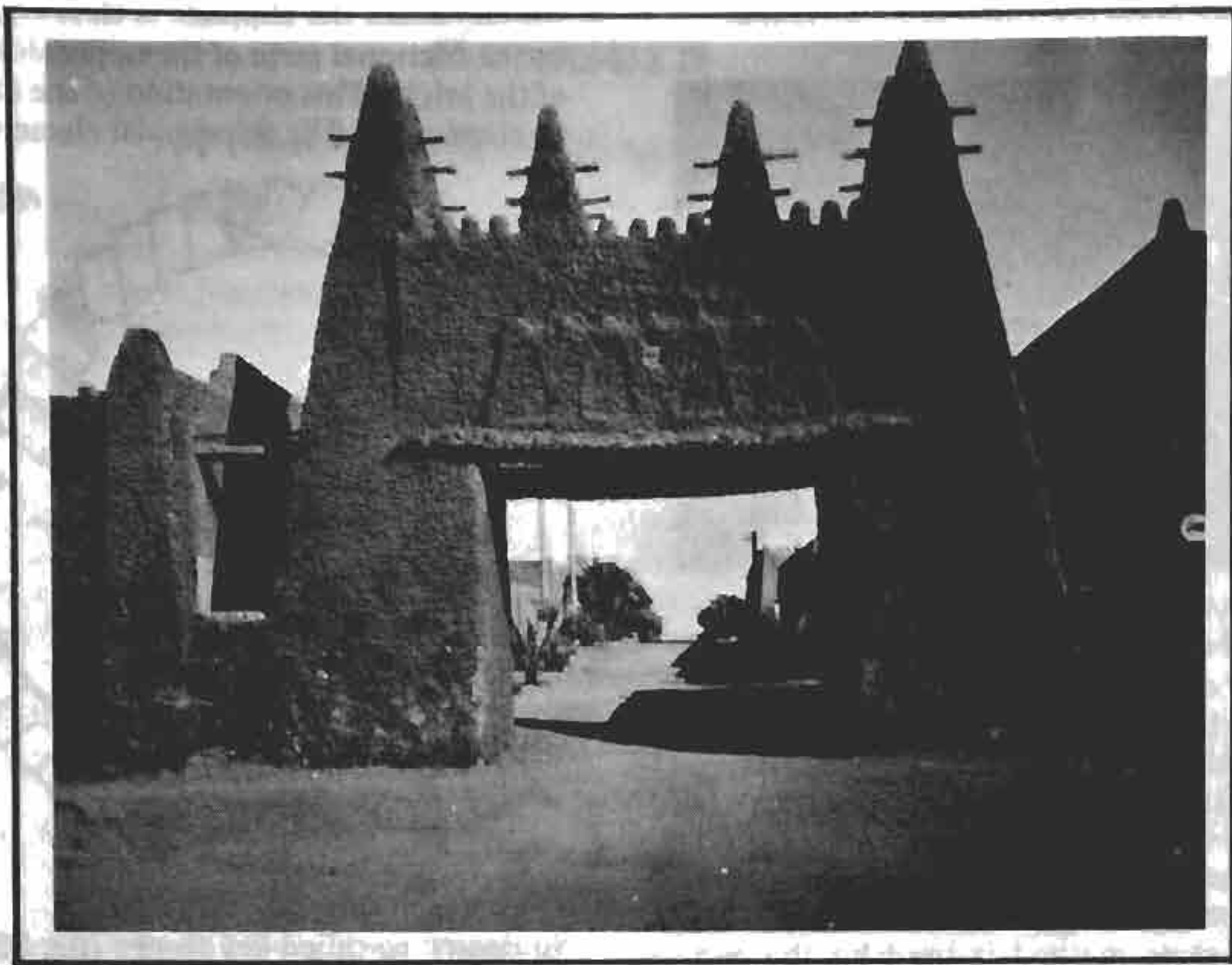

Bernard Ruffin

FIGURE 327: EARTH COATING MADE WITH PROJECTED BALLS OF EARTH

10. RENDERS AND PAINT

Do renders intended for earth houses differ from those used for other buildings? Given the problems they pose, can the use of renders on earth buildings be justified? And if so, what are they made up of and how do they adhere to the wall?

Paint can be applied to a render or directly onto the masonry if the latter has been carefully prepared. In both cases the surface should be clean and free of dust. Painting overheated walls or those exposed to full sunlight is to be avoided.

Apart from industrial paints, the full range of which is presented in the table, there are natural and chemical products which both stabilize and paint the wall surfaces.

Renders

1) Should earth buildings be rendered?

Many earth houses are not rendered. In regions with wet climates (the Vendée and Dauphiné in France, and in Scotland) some earth constructions are left unrendered while others are entirely rendered.

The cost of a render ranges between 50 to 70 FF per m² (1978) which includes 80 to 90% skilled labour. This can double depending on the nature of the site. We also know that rendering earth houses is not always a durable solution. These observations lead us to question the need for rendering. Rendering can be easily dispensed with thus achieving a considerable saving, so long as attention is paid to the following points:

- Protection from driving rain thanks to a low building sheltered by a wide roof overhang.
- Neat exterior finish, achieved with rammed earth by meticulous placing of the forms, regular filling of the joints or by simplifying the design of awkward details (corners, gable-ends). For earth brick masonry, the joints should be regular. They are easier to achieve with bigger blocks than with small bricks.

- Greater stabilization of exposed walls.
- Greater stabilization of the external face of all walls. This is commonly practised in rammed earth construction.

The exterior side of the shuttering is filled with stabilized earth to a width of about 10 cm, the remainder being filled with ordinary earth. Tamping is carried out and the result is an "incorporated render" (fig. 325). Another method consists in inserting an alternate layer of stabilized earth every 15 cm along the length of the exterior shuttering thus making bands of more resistant material.

If one wishes to use a render, the following are the many roles it can fulfill according to the properties it possesses:

- improving the appearance of the wall and disguising its defects;
- protecting it from rain damage and making it water-proof;
- protecting it from knocks and rubbing;
- improving its appearance thanks to the use of colour;
- improving its thermal insulation (light renders).

FIGURE 325: EXTERNAL FACING OF MORTAR LAYERS

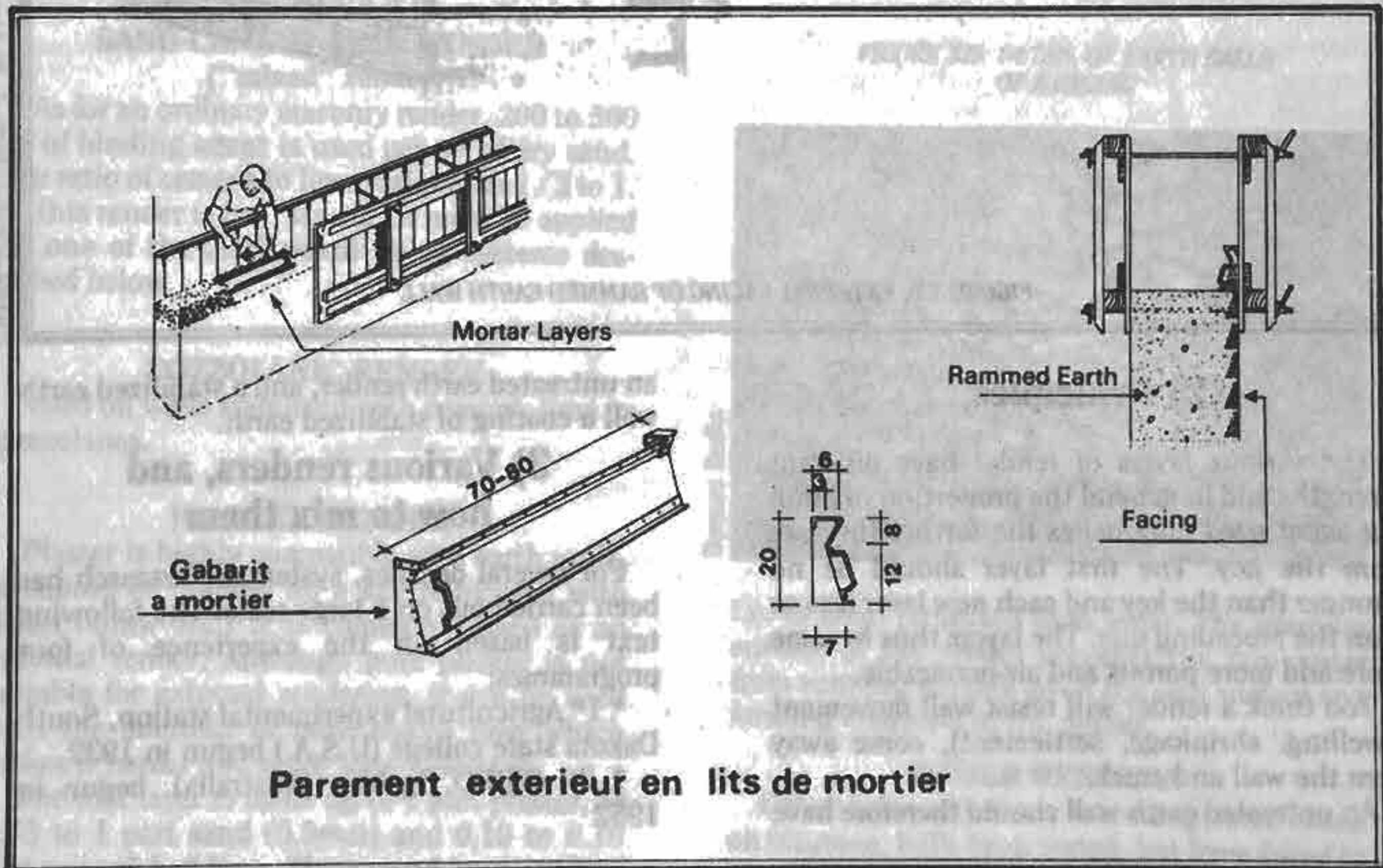

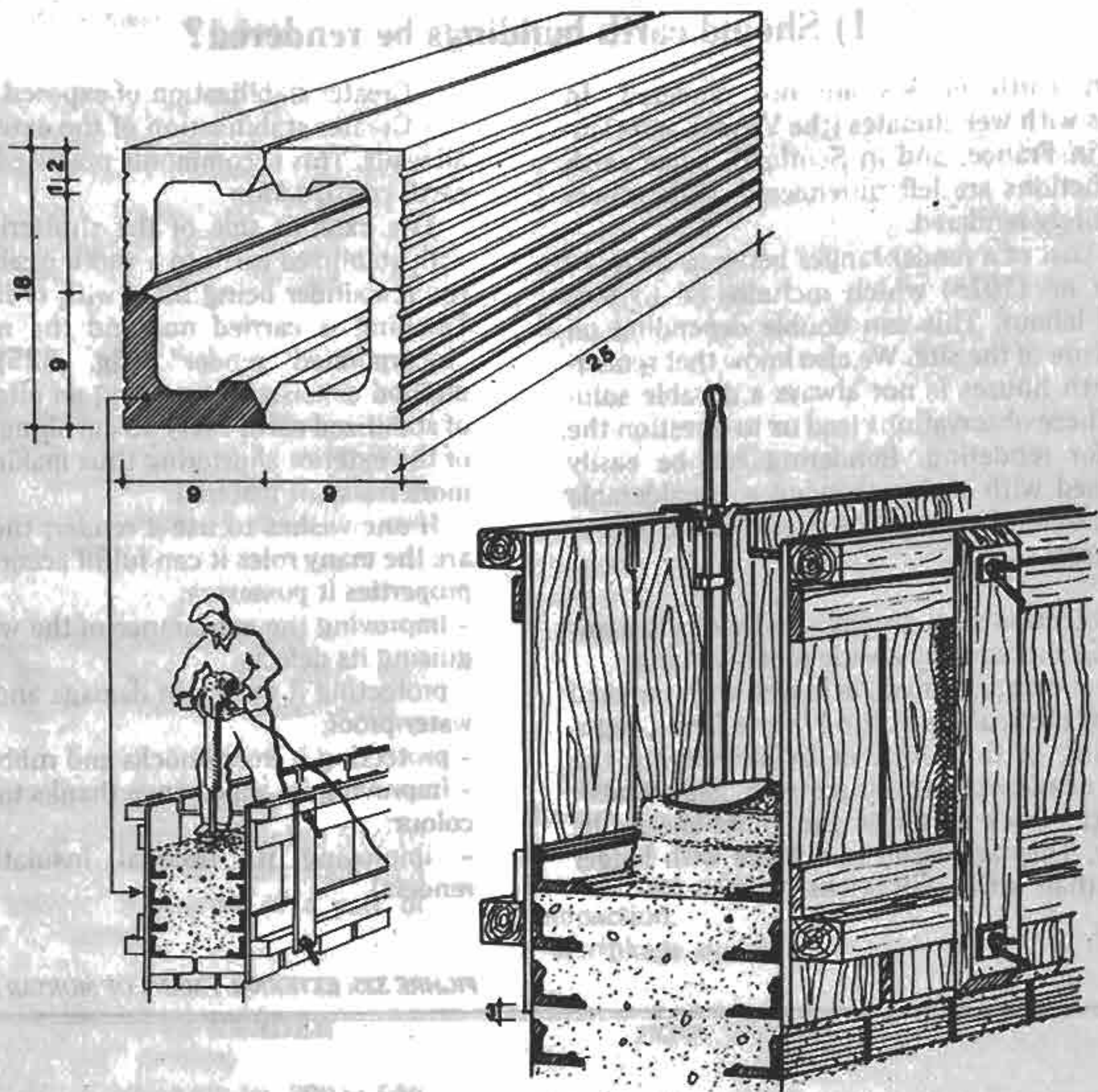

FIGURE 326: EXTERNAL FACING OF RAMMED EARTH WALL

2) Principles

The various layers of render have different strengths and in general the proportion of binding agent used diminishes the further they are from the key. The first layer should be no stronger than the key and each new layer less so than the preceding one. The layers thus become more and more porous and air-permeable.

Too thick a render will resist wall movement (swelling, shrinkage, settlement), come away from the wall and crack.

An untreated earth wall should therefore have

an untreated earth render, and a stabilized earth wall a coating of stabilized earth.

3) Various renders, and how to mix them

For several decades, systematic research has been carried out on a large scale. The following text is based on the experience of four programmes:

- * 1° Agricultural experimental station, South Dakota state college (U.S.A.) begun in 1932
- * 2° CSIRO, Sydney (Australia), begun in 1952

• 3° National Laboratory of building and public works, Dakar (Senegal) begun in 1954

• 4° National Laboratory of Public Works, Brazzaville (Congo), begun in 1955.

All renders should be made from soil containing 50% less clay than that used for the wall. A greater proportion of sand will avoid cracking.

Lime-based renders are a great deal less plastic than those stabilized with cement. They "craze" much less and are therefore more waterproof.

SOIL RENDER (DAGGA)

The same soil as that used for the walls is used with a little more sand. It can be stabilized with natural products. Vegetable fibres are particularly recommended.

CEMENT-EARTH RENDER

One part cement to ten parts earth, this render is intended for cement-stabilized walls.

LIME-EARTH RENDER

Mix one part lime (pure if possible) to 5 to 10 parts earth. This render is for walls stabilized with lime or cement. A quarter of a part of cement can also be added.

SAND-CEMENT-LIME RENDER ("mixed" render)

As for an ordinary masonry render, 200 to 500 kg of binding agent is used per m² of dry sand. The ratio of cement to lime varies from 1/3 to 1. As this render is too "strong" it must be applied on one of the mechanical fixing systems described below.

POZZOLANIC RENDER

Used on walls stabilized with cement, lime or pozzolanas.

PLASTER RENDER

Plaster is highly compatible with earth walls. It should be applied on a key reinforced with fibres (straw etc.) It is commonly used as an external render. Although pure plaster is not suitable for external rendering, it can be used with the addition of pure slaked lime which makes it harder and more water-resistant.

The first layer is made up of 1 part plaster, of 0.75 to 1 part sand (0.5mm) and 0.10 to 0.15 part pure slaked lime. The second layer is iden-

tical to the first but contains no sand. A fluosilicate solution sprayed onto the wall a few days later improves the render's impermeability.

FIBRE REINFORCED RENDER

Renders can be reinforced with natural or artificial fibres (fibreglass, polypropylene). These increase the render's ability to withstand knocks and wear-and-tear and lessens the appearance of tiny cracks. They are generally added in quantities of 20 to 30 kg per m³ of earth.

LIGHT RENDERS

These are industrially produced renders made up of a mix of cement, lime, small gravel and auxiliary products (water repellents and air entraining agents). They are very supple and insulating but need a fixing system.

BALLS OF EARTH

Balls of earth 5 to 7 cm in diameter are thrown forcefully against the wall, where they flatten out. The wall is thus covered with 10 cm hemispheres which have undergone dynamic compaction.

Shrinkage occurs only between the lumps,

FIGURE 328: DETAIL OF EARTH BALLS OF A FACING

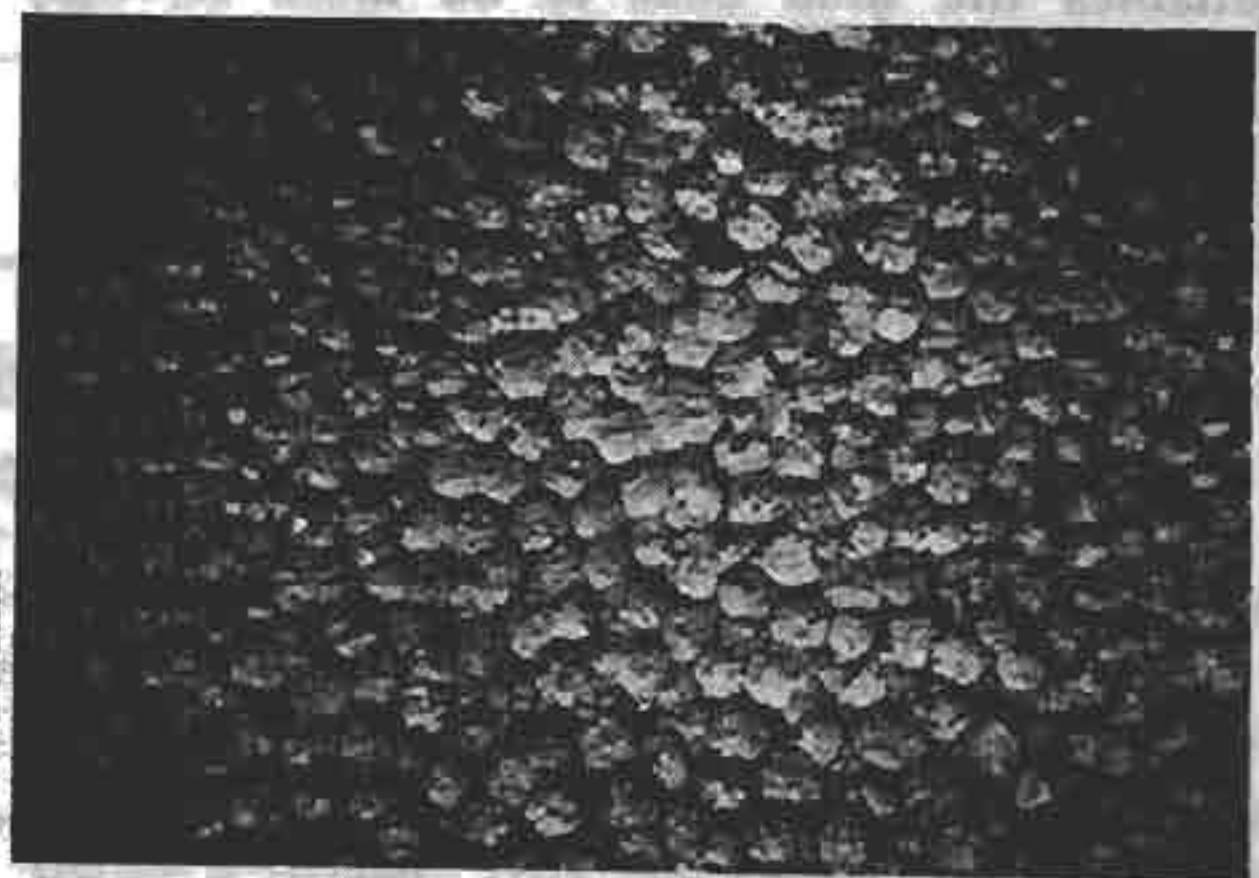

Bernard Ruffin

i.e. in areas protected from water. The irregular surface of the render prevents the rain water from running quickly down the wall surface and forming channels in the render.

OTHER RENDERS

Other types of render, including some based on bitumen, have been tested, but have failed to give good results.

4) Preparing the wall

Renders are applied to dry, stable walls which are prepared in the following ways:

BRUSHING TO REMOVE DUST

A hard or wire brush is used to remove all surface dust working down from the top of the wall and starting with the windward side. This operation should be carried out after each of the other preparation stages.

SCORING

The wall is scored in a crisscross pattern with a rake taking care not to penetrate the main body of the material.

CHISELING

A mason's chisel or pneumatic chisel fitted with a wide indented blade is used to chisel the wall. This is a long process but gives additional compaction to the surface.

BASE COAT WITH HOLES

Once the surface has been scored and brushed down a fairly liquid first layer of slurry is applied. When it is nearly dry, a second thicker layer, reinforced with fibres, is thrown on to a depth of 1.5 cm. An appropriate tool is then used to poke oblique holes 2 cm in diameter and 7 cm apart in this second layer. This enables the final coat to be more strongly stabilized.

EMBEDDED NAILS

Nails are placed in conical holes 4 cm in diameter in the surface of the bare wall. Alternatively, wide-headed galvanized nails are driven into a first layer 7 mm thick every 12 cm in an irregular pattern to avoid long cracks forming.

WIRE "NET"

Every 20 cm a 7 to 10 cm nail is driven in and left to project 5 to 8 mm above the surface of the wall. 0.5 to 0.7 mm galvanized iron wire is then attached to the nails to form a kind of net.

CHICKEN WIRE

Galvanized chicken wire, with 5 cm hexagonal meshes is fixed to the wall using 7 cm hooks. Ceiling mesh can also be used (without the cardboard) or bonded metal.

POTTERY WASTE

In the case of rammed earth walls, broken pieces of pottery can be placed every 15 cm along the shuttering during tamping. After drying, the earth around the ceramic pieces is scratched away enabling the render to adhere to them.

SCORED JOINTS

For masonry walls, the joints between bricks are carefully scored to a depth of 2 cm.

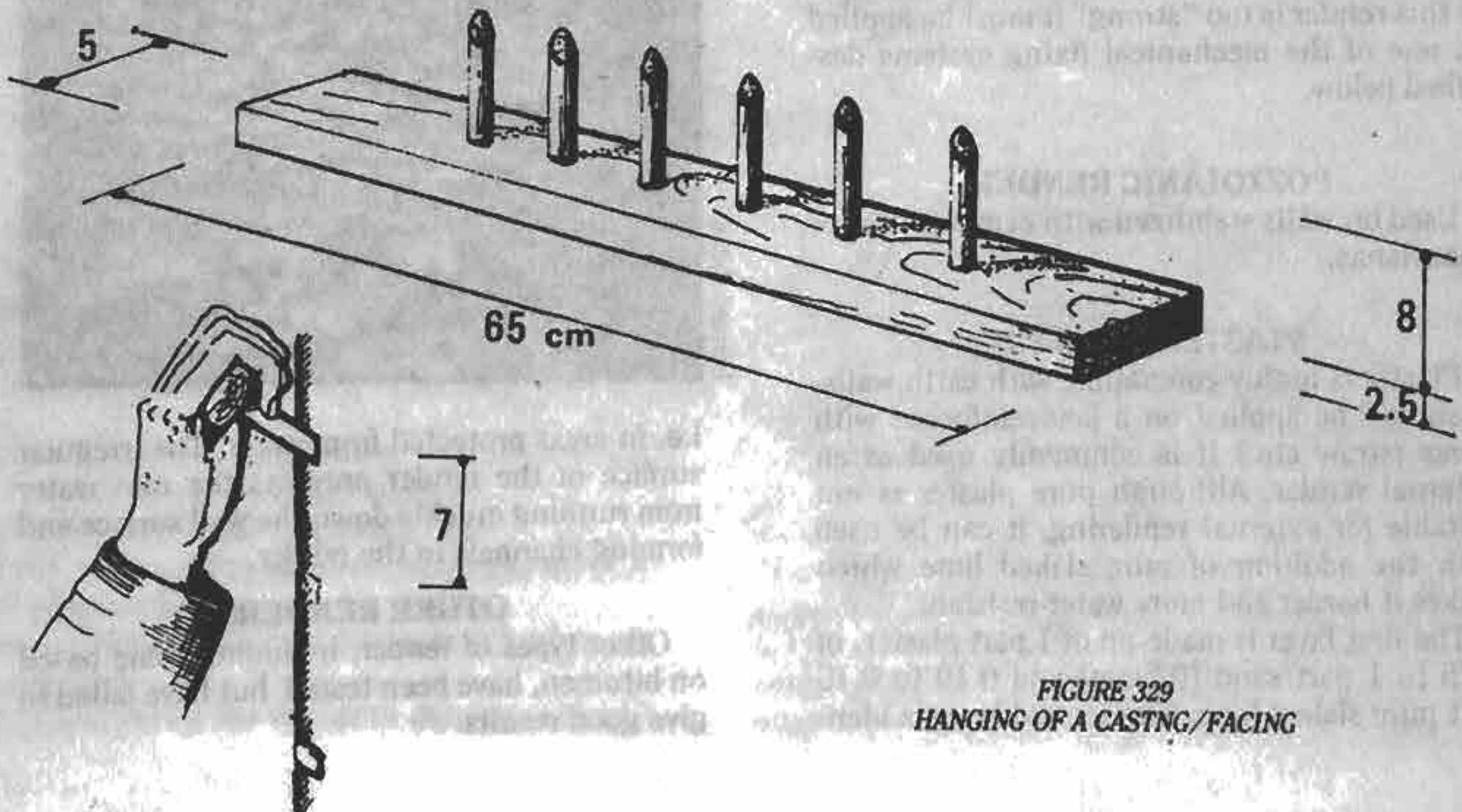

FIGURE 329
HANGING OF A CASTING/FACING

HOLLOWED OUT BLOCKS

Blocks which have been hollowed out are laid in such a way that their "hollow" sides are to the outside of the wall and allow the render to hold.

WOODEN ELEMENTS

Any wooden elements (lintels, ring beam, etc.) to be rendered should be covered with craft

paper nailed into place. Wire netting overlapping by 20 cm is then nailed to the wall.

In short, in our view more attention should be paid to the fixing method than to the composition of the render itself.

SYSTEMS USED TO PROVIDE A KEY FOR RENDERS

Processes	Construction method	Comments	Efficiency
scoring	rammed earth	to be done in all cases	mediocre
chiseling	rammed earth	laborious	mediocre
base coat with holes	rammed earth	specially for stabilized renders on unstabilized walls	very good
embedded nails	rammed earth/ adobe	laborious	medium
wire "net"	any	expensive; for use mainly with soft walls	very good
chicken wire	any	very expensive; for use mainly with soft supports	excellent
pottery waste	rammed earth	the pieces have to be well embedded	good
scored joints	Adobe compacted blocks	more efficient with small blocks	very good
hollowed out blocks	compacted blocks	requires special blocks	good

5) Applying the render

PRECAUTIONS TO BE TAKEN

Renders should be applied neither in very cold weather (below 5°C) nor in very hot weather (over 30°C).

- Avoid direct sun and too high a wind.
- Thoroughly wet the wall before applying the key.
- Make horizontal and vertical joints in order to work in 10 to 20 m² single sections.
- Finish each facade in a single day.
- Take care with the edges of openings and door and window frames.
- Do not apply renders to footings or horizontal elements.
- Avoid allowing the render to dry too quickly.

APPLICATION

Traditionally, the render consists in three layers each with a different role to play:

a) **key or fixing layer:** on a well-prepared surface, a fairly liquid mortar is thrown with force using a trowel. This layer must form a bond between the wall and the body of the render. Its thickness varies between 2 to 4 mm. It does not need to be very smooth; the surface must simply be "dirtied".

b) **body of the render:** this is applied 2 or 3 days after the key in one or two layers to reach a depth of 8 to 20 mm. This layer is strong and water-proof and is smoothed with a straight-edge. After allowing time for it to set, it is gone

over again with a trowel to improve its compactness and close up any tiny cracks. This layer is then scored in different directions with a trowel or brushed down to improve the adherence of the final layer.

c) **finishing layer:** this is the decorative layer, 3 to 6 mm deep. It can be treated in various ways depending on the desired effect:

- Left as it is as a rough-cast finish of more or less gravelly texture ("Tyrolien" render).
- Working on it before it has hardened: rotating brush finish, plastering, brushing, scoring (ribbed finish). Decorative effects can be achieved by scoring some sections, whilst leaving others smooth.
- Working on it after it has hardened: honey-comb or speckled finish.

PARTICULAR TECHNIQUES FOR PROJECTING RENDERS ONTO WALLS

The average daily rate for a very skilled worker

working by hand is 10 to 20 m of render. This can be increased with the help of various mechanical processes:

- **"Tyrolien" box:** this is a metal box fitted with a hand-turned paddle which projects the mortar onto the wall;

- **pneumatic spray-gun with funnel:** the mortar is poured into the funnel at the bottom of which is a hand-held spray-gun which projects the render. The spray-gun is linked to a pneumatic compressor;

- **appliance for mixing and applying renders:** these machines mix the mortar which is then driven under pressure through flexible tubes to the projection head. Their pumps will operate up to heights of 30m and at distances of 70 m. Their output varies between 80 and 120 m² per hour for the body of the render. A team of 3 or 4 men can thus realise 150 m² of wall per day.

6) Stabilizers

The three usual stabilizers, cement, lime, and bitumen, can be suitable. In general, one should use exactly the same proportion as that of the walls. For a more highly stabilized render, it is better to use an efficient fixing system.

NATURAL PRODUCTS

A number of stabilizers sometimes used in particular regions are listed below. Although these have not been subject to any systematic research on their durability, as the only local materials available they are nevertheless used:

● **Agave:** The juice of this Mexican plant can be used to make both alcoholic drinks and a stabilizer...

● **Shea (Karité) "butter":** This is a kind of vegetable fat sometimes known as "golam butter". It is extracted from the edible almond of the fruit of the Karité tree, native to tropical Africa (Sapotacean genus). A mature tree can produce approximately 350 kg of almonds per annum. The crushed almonds are thrown into boiling water and the oil which floats to the surface is skimmed off. This solidifies at around 37°C and forms "Karité butter". The use of an edible product to stabilize a soil is perhaps wasteful, but it is often possible to obtain it as waste. It is often used in association with gum

● **Cow dung:** used as a binding agent to increase the cohesion of the render.

● **Cactus Optuntia:** a sappy plant similar to the Barbary fig-tree: its juice is toxic.

● **Flour:** with 15 litres of flour boiled in 220 litres of water one obtains a paste which is then added to the soil.

● **Euphorbia latex:** these ligneous herbaceous plants (of the Euphorbia family) contain a white latex. This is a powerful antiseptic and is dangerous if it comes into contact with the eyes, as it can lead to temporary blindness lasting 2 or 3 days. Its efficiency as a stabilizer is debatable.

● **"Néré":** the dark red juice used is obtained by diluting the powder found in the fruit in July.

● **Peulh soap:** this is casein diluted and beaten into a paste. It resembles tree gum. Before adding to the soil it should be carefully mixed with brick dust.

Finally the **urine of cattle** is sometimes used together with fibres.

Paint

Two types of paint deserve particular attention because of the value for money they represent:

white-wash and banana juice.

1) White-wash

Unsophisticated and cheap as it may be, whitewash is certainly the most appropriate form of paint for earth walls. It reflects the sun's rays well and is a good antiseptic, resistant to alkali and the excrescences of bitumen. Additives are, however, needed to improve its weather-resistance as it is not very durable. It is

applied by spraying or with a brush and is easily dyed. It is generally accepted that white-washing should be done twice a year: before the autumn and after the winter, or before and after the rainy season.

See page [244] for table giving 12 alternative white-wash mixes with quantities.

2) Banana juice

This is obtained by cooking the finely chopped leaves and stalks of the banana tree in water, stirring constantly. When the liquid

thickens, it is strained. It can be used undiluted or mixed with laterite. This paint can last from 1 to 3 years and withstands torrential downpours.

3) Industrial paint

- **Distemper:** usable on all walls except those most liable to crumble. Should be completely removed before applying any other kind of paint.

- **Silicon paint:** does not always give good results.

- **Latex paint:** very efficient on cement-stabilized soil.

- **Cement paint:** can last up to 8 to 10 years on cement-stabilized walls.

- **Oil-based paints:** a first coat is needed to neutralize the alkaline in the wall and eliminate bitumen excrescences.

- **Resin-based paints:** often efficient.

- **Cut-backs:** can be applied directly onto the wall turning it grey or black.

4) Chemical products

Some chemical stabilizers for clay usually used to treat the body of the wall or the render can be applied as a paint. Instead of incorporating them into the soil during mixing, they are simply used to coat the surface of the walls. These products penetrate the material to a greater or lesser extent, but do stabilize the surface.

- **Sodium silicate:** a brush is used to spread one part sodium silicate (40° baume) in solution

with 3 parts water. Two succeeding coats are needed.

- **Paraffin:** paraffin is diluted in benzine and spread at a temperature above 21°C.

- **Water repellents:** these are silicone-based products: HYDROSOL, SECO SEAL, CONSIL, CONSERVADO 5.

These products are expensive and have to be used in large quantities.

5) Natural products

Natural stabilizers used for renders can be used as paint. To the list of products given above can be added soft cheese paste and household soap. The latter is made up by dis-

solving a bar of soap containing stearic acid in 15 litres of water. Two litres of cement and two litres of sand are then added to obtain a paint.

TWELVE ALTERNATIVE WHITE-WASH MIXES

INGREDIENTS

Products	Unit	Previously dissolved in	1	2	3	4	5	6	7	8	9	10	11	12
quicklime	kg		20	20	20	20	20				20			
slaked lime	kg							20	20	20		20	20	20
water	ltr		47	40	40	49	40	24	24	52	40	50	50	40
tallow	kg	hot water	2											
coarse salt	kg			5	0.6	0.8						1	2	
Portland cement	kg			2										10 to 20
zinc sulphate	gm	3.2 ltr. water			320									
skimmed milk	ltr				6.5									
rye flour	gm	1.6 ltr. + 6.5 ltr. water				800								
animal glue	kg	10 ltr. boiling water					1.4							
cosein glue	kg	8 ltr. hot water							2					
trisodium phosphate	kg	4 ltr. water.							1.2					
formaldehyde	ltr	12 ltr. water							1.5					
alum	kg	boiling water								0.15	1	0.45	0.45	
linseed oil	ltr									0.8				
molasses	ltr											6.2		

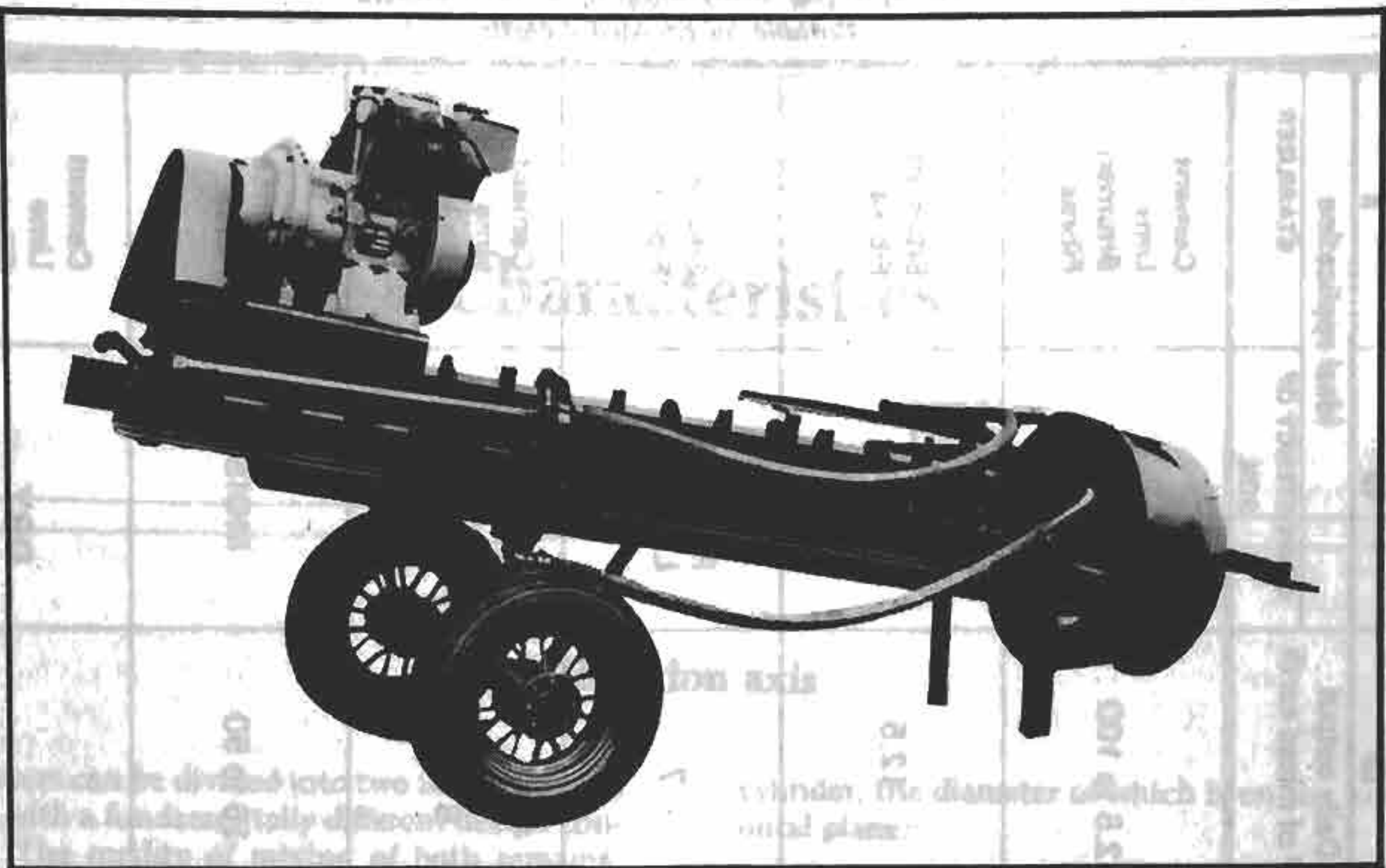



11. MECHANICAL MIXERS

This chapter lists some mixers which can be used to prepare earth. They are classified in a table according to six types: an explanation of their characteristics is given together with the addresses of manufacturers.

It should be noted that soil concrete, whether stabilized or not, does not behave in the same way as normal cement concrete. This is because it has considerable intrinsic cohesion, which ordinary concrete does not. Some of the material to be mixed, the clay element, naturally contains a not insignificant amount of water which makes a homogeneous mix difficult, particularly a thorough mix of earth and stabilizer.

On no account should normal cement-mixers be used: i.e. those with horizontal drums rotating in alternate directions or with inclinable rotation drums. It may be possible to use them for adobe after a sufficiently long soaking period.

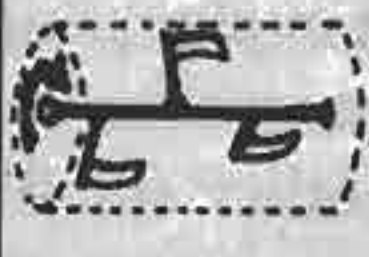
The table (fig. 330) suggests a list of mixers suitable for preparing earth.

1	2	3	4	5	6		7
					ROTATION AXIS	MIXING SYSTEM	
VERTICAL ROTATING SHAFT MIXERS 	BLADES 	① TURBO-MIXER	250/180 to 3000/2500	12.5 to 100	DRY	Cement Lime Bitumen Fibres	
	GRINDSTONES 	② VERTICAL MIXER	250/180	12.5	PLASTIC LIQUID	Bitumen Fibres	
HORIZONTAL ROTATING SHAFT MIXERS 	GRINDSTONES 	③ GRINDSTONE MIXERS	80	7	PLASTIC LIQUID	Bitumen Fibres	
	BLADES 	④ HORIZONTAL BLADE MIXER	200/130 to 350/230	8 to 19	DRY PLASTIC LIQUID	Cement Lime Bitumen Fibres	
	DISCONTINUOUS HELICAL SCREW INTERROMPUE 	⑤ MIXER LINEAR	16 to 50	MOIST	Bitumen Fibres		
	MILLING CUTTERS 	⑥ MOTOR-CULTIVATORS WITH MILLING CUTTERS			DRY	Cement Lime Fibres	

Characteristics

1. Rotation axis

Mixers can be divided into two main families, each with a fundamentally different design concept. The quality of mixing of both remains, however, very satisfactory.

MIXERS WITH A VERTICAL ROTATING SHAFT

The mixing is done on a horizontal plane, whereas the rotation axis of the mixing mechanism is vertical. The container itself is a

cylinder, the diameter of which is on the horizontal plane.

MIXERS WITH A HORIZONTAL ROTATING SHAFT

Here the mixing is done in a basin or a distorted horizontal cylinder, the diameter of which is on a vertical axis. The mixing mechanism itself is driven by a horizontal axis.

2. Mixing system

BLADES

Blades of various shapes and sizes depending on the size of the container, are propelled by arms fixed to the rotating shaft. They are inclined at different angles in order to obtain the maximum amount of movement in the material being mixed. They are manufactured in very strong steel and are interchangeable. Some of the blades should reach right to the bottom and the sides of the container in order to ensure that it is completely clean when it is emptied.

The shafts propelling the blades often have a suspension system in order to avoid jamming and overloading the motor.

A number of relatively small blades cannot be linked together to form a single helical blade.

GRINDSTONES

Grindstones, sometimes ballasted, turn at the bottom of a container where they crush the

material to make a homogeneous substance. A secondary blade system ensures that the material is thrown back under the grindstones to avoid segregation.

DISCONTINUOUS HELICAL SCREW

Blades soldered directly onto the rotating axis and reaching from the axis to a few millimetres from the sides of the container are mounted in such a way as to create a true discontinuous Archimedes screw.

A few blades are sometimes mounted facing in the opposite direction to slow the movement of the material.

MILLING CUTTERS

(on motor-cultivators)

4 cutters are mounted on the horizontal axis and penetrate the soil under the weight of the appliance.

3. Name of type

To make identification of the various mixers easier, manufacturers have given them different names. Sometimes these differ for mixers using systems which are virtually identical. We have

retained the most common names. After a general description, an example of each type of mixer is presented.

4. Normal volumes

The volumes quoted are in litres. The first figure indicates the volume of aggregates which can be loaded into the mixer.

The second indicates either the volume of concrete to emerge from the mixer, or the volume of concrete used and vibrated.

In the first case the relationship is 1.33, in the second, 1.5. These figures have been greatly rounded up or down.

For earth, the volume loaded can be the same, but the volume of soil cement used has a relationship of 1.70. For example, a mixer which can load 500 litres will produce 375 l of

concrete, 333 l of vibrated concrete, and 294 l of applied earth.

Small mixers with a capacity of up to 375/250 litres are often available with petrol or diesel motors.

From 375/200 to 3000/2000 mixers are exclusively equipped with 3 groups of electrical motors: 1 for the mixer, 1 for the hopper, and 1 for opening the unloading trap. The motors must be provided with effective protection from dust and with a so-called "tropical" insulation if they are to be used in hot climates.

5. Daily output

Outputs vary enormously with the rhythm of loading of the mixer and the consistency of the material to be mixed (dry, plastic or moist). We have therefore made a serious attempt to indicate outputs which correspond to a simple infrastructure and which take account of the optimum functioning of the mixer depending

on the consistency of the earth.

For type (1) turbo-mixers and (2) vertical mixers, the approximate daily output can be obtained by dividing the loaded volume by 20. For example, a 750/500 litre mixer will have a daily output of approximately 37.5/25 m³.

6. Ideal application depending on the consistency of the earth

DRY

The earth has the consistency of a dry paste and resembles cracked wheat semolina (water content at the Proctor optimum: 14%).

PLASTIC

To be in a plastic state, the mix obtained has the consistency of dough (water content = W_p).

LIQUID

When the mix is liquid, the result corresponds to the consistency of freshly-made adobe bricks, i.e. the material keeps its shape immediately after the mould has been removed like a thick purée (water content > W_p).

7. Stabilizer

The stabilizers mentioned correspond to the consistency of the earth indicated above. Our

concern here is only with conventional stabilizers.

Mixer models

An impressive number of mixers are commercially available. For the five types we have discussed, we simply give a few addresses of some of the best known manufacturers with a well-established reputation among civil engineering companies. Prices are not given, since they will depend on the nature of the infrastructure the mixer will be equipped with.

For very approximate forward budgeting purposes, however, some idea of the price of a mixer alone, including hopper, can be obtained by multiplying the figure given for the capacity of the mixer by 180 FF.

Example: a mixer 750/500 will cost approximately:

$750 \times 180 \text{ FF} = 135,000 \text{ FF}$ (delivered to port, ready for embarkation)

1. Turbomixer

Turbomixers, which are very common, are made by a great number of manufacturers. Some operate on concentric action and some on forced action. Some models have a rotating tank, but mostly the tank is stationary. Unloading is done through to a central or lateral trap.

These mixers are nearly always equipped with electrical motors. Some manufacturers provide models with a maximum capacity of 350 ltr with diesel motors (fig. 331).

Manufacturer: Rock (France) - Route de St. Pierre - 07200 Aubenas



FIGURE 331

Rock

2. Vertical mixer

This type of mixer is particularly suitable for



FIGURE 332

Villers Pervin

adobe brick production. It can be manual or mechanical (fig. 332).

Manufacturer: Les Ateliers de Villers Perrin (Belgium), 210 rue Emile Gossieux

3. Grindstone mixer

Grindstone mixers are ideal for manual adobe brick production (fig. 333).

Manufacturer: LINER (England), B.P.O. Box 12, Park Road, Gateshead NEB 344.

FIGURE 333

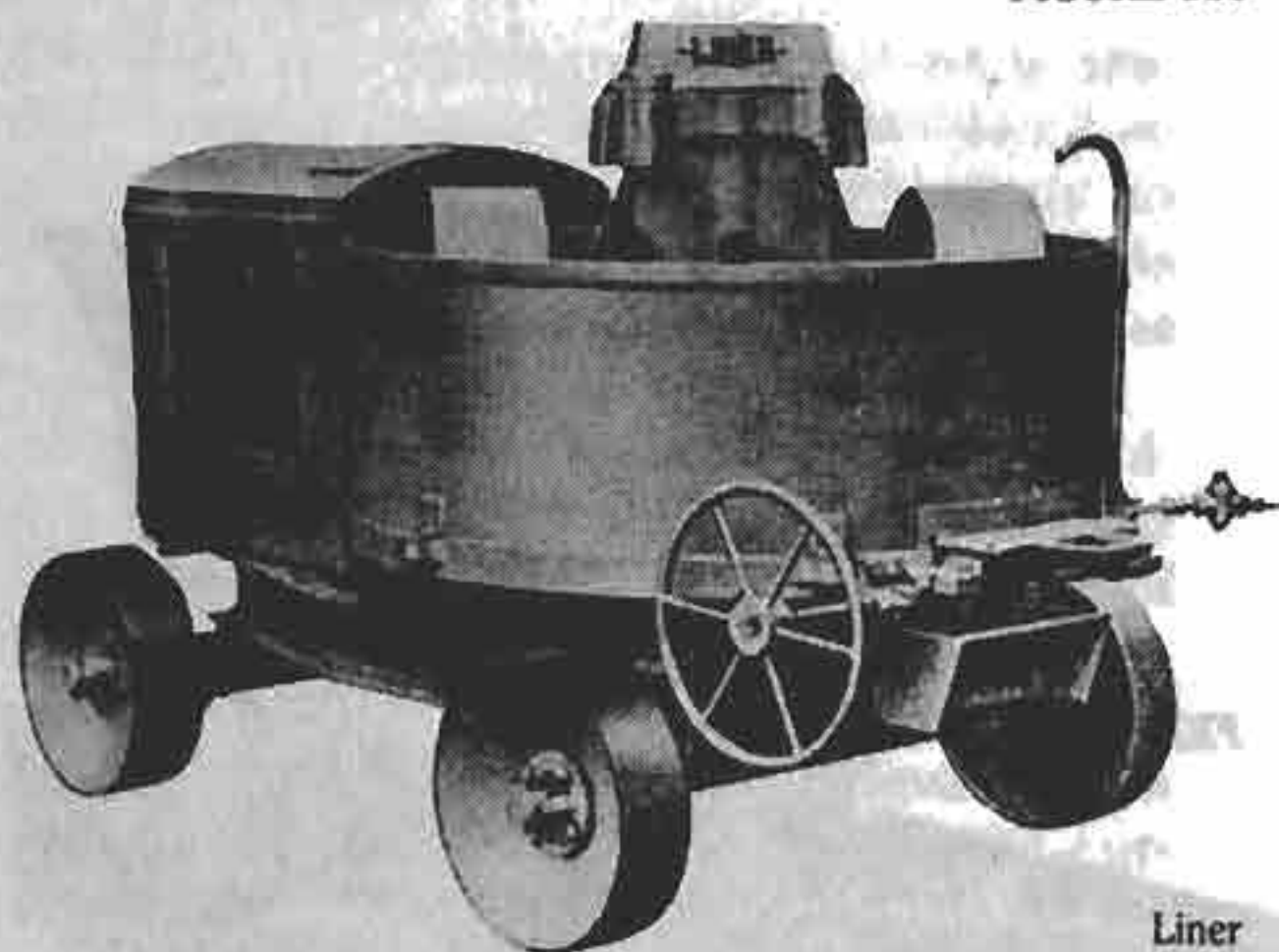

Liner

4. Horizontal mixer with blades

These mixers are the easiest to handle and the most convenient to use. This type of mixer is mounted on the CLU 2000 press (fig. 334).

Manufacturer: MULLER Machinery Company (U.S.A.) Netighen - New Jersey 08840.

FIGURE 334



Muller

5. Linear mixer

These mixers have a continuous output. A synchronized system enables the necessary amount of water and bitumen to be added (fig. 335).

Manufacturer: CREUSOT-LOIRE (France) Division Ermont, 16 rue Chauveau Lagache, 75383 Paris.

FIGURE 335



Creusot-Loire

6. Motor-cultivator with milling cutters

This machine has been used in G.D.R. and although it was not originally designed for mixing can be suitable for mixing dry soils. There is less handling as the earth is processed on the spot. The machine ensures a deeper and faster result than that achieved by manual mixing (fig. 336).



Manufrance

WHAT IS NEW AT CRATERRE?

Established in 1979 by the five co-authors of "Building with Earth", CRATERre has since been joined by three new members:

- BELMANS Dirk, architect — town planner
- DAYRE Michel, engineer
- GUILLAUD Hubert, architect.

Currently the association is developing three main fields of activity:

● **RESEARCH:** laboratory research is left to specialist organisations. CRATERre undertakes fundamental research and focuses particularly on knowing what has happened in the past, what is happening now and what will happen in the future.

● **TRAINING:** in the context of promoting building with earth, training remains an essential stage. With the collaboration of the School of Architecture of Grenoble, CRATERre has developed training programmes from 2 days to 6 weeks in length, suitable for all levels, from builder to planner. A 6-month course is currently in the course of preparation.

● **IMPLEMENTATION:** without implementation, research and training remain sterile activities. Similarly, implementation without training and research is doomed to failure. CRATERre is out on site, designing and managing projects and providing technical assistance.

At present our two sister organisations, geographically distant from each other, work independently: CRATERre and CRATERre Peru.

CRATERre

- Historical and technical research as well as on standardization of tests, analyses and adequate trials.
- Preparation of manuals for various clients:
 - *Recommandations pour la conception*, 205 pp.
 - *Recherche exploratoire*, 470 pp.
 - *Earth construction manual*, 200 pp.
 - *Protection du matériau terre*, 300 pp.
- Professional training programmes at Grenoble, and in Belgium, Senegal, Mexico etc.
- Technical assistance on projects including:
 - Building programme for 63 "H.L.M." (moderate rent public housing) units in earth at Isle d'Abeau (Isère, France).

- Setting-up and monitoring of 25 brick-works, building of 8 social housing units and assistance with the building of 350 housing units per year by craftsmen and self-help builders - with the S.I.M. of Mayotte.

- Technical assistance to professional builders, material manufacturers, contractors and architects, in Europe as well as in Africa etc.

CRATERre Peru

(see pages 262 to 272 for details)

- Research on earthquake-resistant building systems.
- Design, start-up and running of a research, analysis and testing laboratory.
- Setting-up of a workshop manufacturing production materials.
- Development of a manual press.
- Professional training in a rural environment.
- Construction of silos, dispensaries and health centres, community centres, agricultural warehouses etc.

Specialized documentation center

- Bibliographic index of more than 3,000 titles.
- Library containing over 1,000 titles.
- Slide-library of more than 10,000 slides covering 15 building techniques, hundreds of buildings, dozens of projects and building sites in over 40 countries.

Memberships

- IAHS: International Association for Housing Science (California - USA).
- AGRA: Association Grenobloise de Recherche Architecturale (Grenoble, France).
- REII: Rammed Earth Institute International (Colorado -USA).

CRATERre
Centre Simone Signoret
B.P. 53
F- 38090 Villefontaine,
France

CRATERre Peru
Apartado Postal 399
Huancayo
Peru

RECENT, CURRENT AND FORTHCOMING EVENTS

"Earth architecture or the future of a thousand-year old tradition". This major exhibition at the CCI of the Georges Pompidou center, plateau Beaubourg, Paris, was designed by the architect Jean Dethier and ran from October 1981 to January 1982. The current revival of interest in mud building and its architecture has undoubtedly much to owe to this extraordinary exhibition. Apart from paying tribute to earth as a building material, its historical, plastic and aesthetic genius, it also drew attention to the extent of popular knowledge and the practical responses of earth architecture to the energy wastefulness of international-style building as well as to the immense need for housing for the underprivileged. Above all, it stimulated the revival of a genuinely argued international debate.

The full exhibition is currently touring several European cities, including Frankfurt and Rome; a 5-year world tour is planned, which will take in the continent of Africa, Algiers, Tunis, Fez and Nairobi, before returning to Brussels, then Montreal and probably other capital cities. An important technical dimension is soon to be added to the original content of the exhibition and will provide specialized information in response to demand from many visitors, keen to learn more. An abridged version, appropriately dubbed the "mini-expo", consisting in nearly 80 photographic panels with text, has enabled the essential documentation of the CCI to circulate through most of the regions of France, stimulating local debate on the building heritage, its maintenance and rehabilitation as well as on the revival of regional earth architectures. This mini exhibition can be counted a genuine success, if we consider that it has completely escaped the control of its promoters; only recently it was to be found on its foreign itinerary on the sino-soviet border in Tashkent in Ujbekistan. Several international symposia have been organized around this exhibition as it continues to circulate, bringing together numerous acknowledged experts and stimulating very high-level debate on all matters touching on the many uses of earth as a building material.

RILEM (International Union of Testing and Research Laboratories for Materials and Structures)

The RILEM general council which met in September 1982 has officially formed a new technical committee 63-LBM on "Laterite-Based Materials", devoted, as its name suggests, to the experimental study of laterites as building materials and to the possible definition of testing methods for them.

A number of national and international competitions on earth architecture have recently been launched.

- in 1981, *the Provence-Côte d'Azur region (France)* organized a competition for the creation and building of a center for technological research, within the premises of the School of Architecture of Marseille-Lumigny. The center was also to be an experimental center for low-cost housing. This project was one aspect of Marseille's aspiration to place itself in the economic and scientific vanguard of France, with particular reference to north African countries. The adobe brick, or compressed, or extruded bricks, as well as rammed earth, were all materials used in the earth technology exploited by the various original architectural propositions, of which one is soon to be built.

- Also in 1981, *EPIDA*, which promotes and manages the development of the new town of Isle d'Abeau, south-east of Lyon (France), launched a competition for the building of 63 moderate cost housing units.

The OPAC of Isère, the principle contractor, has shown itself to be commendably responsive to these experimental technologies, if one concurs with the historical fact that this is a revival of construction methods long-forgotten on these shores. Plan-Construction, co-funder of the operation, underlines its wish to stimulate experimentation and provides an outlet for the considerable amount of research work already undertaken. The Isle d'Abeau operation will demonstrate the potential of earth as a material acceptable to builders and public alike as a technically and economically feasible building method. The architectural proposals selected

DID YOU KNOW?

The most massive and heavy building ever to be built by man was built with earth. It is the Hauca del Sol, in Peru. In his book, "Inca", Enrico Guidoni describes the research done into this extraordinary pyramid, the gigantic ruins of which still dominate the sacred site. Built on a base 1,000 x 500 m, the building must have been nearly 35 m high. Its structure contained no less than 130,000,000 adobe blocks, its volume was approximately 5,800,000 m³, and it is estimated to have weighed 8,800,000 tons. This represents 3,000,000 tons more than the official record holder (in the "Guinness Book of Records 1982") the Pyramid of the Sun at TEOTIHUACAN, near Mexico, which weighs "only" 5,940,000 tons for a volume of 3,300,000 m³.

Earth is the most widely used building material in the entire world. At least 1,500,000,000 people, or one third of the human race, occupy and live in earth dwellings. (Dr. Uppal, CBRI).

The official summer residence of Ronald Reagan, former President of the USA, the "Summer White-house", is a 5-room Mexican ranch located at Santa Inez, California. This building of approximately 170m² was built in adobe almost a century ago. (Round up, 22 February 1981 - "Rocky Mountain News", 22 March 1981).

The longest construction in the world, which is also the only one visible from the moon, is partly built with earth. The Great Wall of China is 2,250 km long and its structural core is built in rammed earth over numerous sections. This earth structure was then covered with stone cladding (Christopher Fagg and A. Sington in "Autrefois les batisseurs").

through the competition also testify to the determination to provide a very modern and vigorous adaptation to the climate and the site, with a resolutely bio-climatic aspect, enhanced by a regionalist or post-modernist approach. Despite various difficulties attributable to the technical and economic constraints imposed on the designers and the associated companies and contractors, the 63 earth housing units are today being built.

The campus of the University of Meknès, in Morocco, is currently the subject of an international competition and will be built in earth. Accommodation for 400 students in a 2 or 3-storey building will exploit rammed earth technology, a traditional local building method, witness the numerous kasbahs and the prestigious ksours of the valleys of Draa, Dades and Rherif of the Moroccan heritage.

Building with earth is now also the prerogative of specialized building companies.

● In the USA, and more particularly in the south-west (Texas, New Mexico, Arizona, California) a number of companies, material manufacturers and designers, are exclusively concerned with building with earth. The Albuquerque magazine "Adobe Today" specializes in this building method and regularly reviews research into the subject and the latest technical and architectural news. The same region boasts more than 48 adobe brick production units, from workshop to industrial scale. These produce nearly 4,000,000 blocks a year which flood the local building market at very competitive prices, challenging the established technologies of concrete and wooden frames. New neighbourhoods, such as La Luz or Tramway Road Albuquerque, eminently residential, are virtually completely built with earth. In Arizona, the Smith Brothers company has spearheaded the promotion of rammed earth solar passive architecture. In the USA, earth building has now been awarded its own Uniform Building Codes, its official credentials.

In Australia, RAMTEC is reviving the embattled tradition of rammed earth construction which up till the beginning of the century produced many buildings as well as various publications, the relevance and technical soundness of which are internationally respected by specialists and informed enthusiasts of earth building.

In France, at present the "Terre et Soleil" company, the Corsican group "A Volta", and a Toulouse group "Archéco" promote the use of rammed earth and compressed block building, no doubt soon to be followed by others, perhaps in response to demand from an increasing

FIGURE 338: "SOFT HOUSE". SOLAR HOUSE BUILT BY COLZANI J.H. OF THE ARCHECO GROUP OF TOULOUSE. THE HEAT RETAINING INTERIOR WALLS ARE IN STABILIZED EARTH WALLS.



Colzani J.H.

number of self-help builders. Companies specializing in the restoration of old rammed earth or mud-brick buildings are legion in the Dauphin and the south-west regions. Finally, the companies tendering for the Isle d'Abeau operation, with this first experience under their belts, will perhaps now swell the ranks of their predecessors, following in their resolutely professional footsteps.

Interest in earth is growing among industrialists. This is an entirely new phenomenon in the history of building with earth. In several countries, Algeria, Brazil, USA, France, massive investment can be observed both in the development of production materials suitable for domestic needs as well as export and in the setting up of an industrial production process for materials, mechanically moulded, compressed or extruded bricks, crushers, mixers, presses, mobile or integrated production units. This is now a truly viable market. This makes it reasonable to claim that the current interest in earth is not simply a temporary passing phase, but is here to stay; the thoroughness, determination and seriousness with which it is approached testify to a presence of hitherto unknown vigour and energy.

NEW PROJECTS

We review here some recent or current projects of particular interest from a wide range of points of view including their prestige, esthetic qualities, social and economic housing function, and other criteria of interest.

- **La Luz Residential Area:** a suburban neighbourhood of Albuquerque (New Mexico, USA) of 100 deluxe housing units built in adobe brick. Designed by American architect Antoine Predock and completed in 1975.

- **La Vereda 2:** an estate of some fifteen passive solar adobe houses, regarded as the state of the art in this field; built on the heights of San Francisco (New Mexico, USA) by Wayne and Susan Nichols and completed in 1981.

- **National Museum of Mali:** a stabilized mud brick building, built for demonstration purposes, designed by French architect Jean-Claude Pivin. Completed in Bamako in 1981.

- **Project for permanent EDF** (European Development Fund) representative at Kigali, Rwanda; by the Architechna group, 1982-83.

- **Building of the campus of PID** (Pan-African Institute for Development) at Ouagadougou, Upper Volta, by ADAUA.

- **Mayotte island operation:** CRATerre in collaboration with SIM ("Société Immobilière de Mayotte") for the setting up 25 brickworks, the building of 8 houses in stabilized brick and a programme for 350 buildings per year to be built with self-help, 1981-82.

- **Building of 10 social housing units in Bancoul, outskirts of Bamako, in Mali:** undertaken on the context of the Rexcoop programme by the ACA, 1982.

There are of course very many projects in various countries of the world; we note some from France:

- **a bus-shelter and sports-ground changing-room** under the auspices of the National Mountain Park of Reims.
- **various houses being built with self-help near**

Rennes, in the Dauphine, and in the Toulouse area; bioclimatic housing near Toulouse, near Marseille and in the Var department.

- **a community house** in Pigna, an organ production workshop and several houses in Lumio in Corsica.

- **63 "H.L.M."** (moderate rent public housing) units at Isle d'Abeau, near Lyon under the auspices of Plan-Construction with the Isère OPAC and EPIDA ("Etablissement Public de l'Isle d'Abeau").

STUDIES

Several study and research programmes have recently been launched.

UNITED STATES

- **The Southwest Thermal Mass Study,** jointly undertaken by the Pueblo of Tesuque, the DOE, HUD, NMEI Members and Associates and the Bickle Group (New Mexico). This programme aims to provide adobe designers and builders with a complete package of thermal data based on a series of scientific and not just empirical tests. The first results are expected towards the end of 1983.

FRANCE

- **Exploratory research on earth as a building material:** this research commissioned by Plan-Construction and undertaken by CRATerre aims to establish the current state of the art relating to earth and its use for construction purposes and determine the most pertinent areas of research for further study.
- **Renders and protective measures for earth in**

buildings: this research draws on field experience and scientific knowledge of the behaviour of traditional earth building renders and presents an inventory of current protective solutions suitable for use with earth. This research is being carried out by AGRA under the auspices of Plan-Construction.

- **ENTPE:** The National School of Public Works at Lyon in collaboration with CRATerre is undertaking fundamental research, financed by Plan-Construction, into the behaviour of vaults in unstabilized and stabilized mud bricks. Full scale vaults and domes will be analyzed under stress. Mathematical models will then be worked out, as well as tables freeing architects from the need for a laborious calculation and enabling them to build with complete confidence. One of the principle advantages will be to exploit to the maximum the advantages, structural, mechanical and static, of various earth vault forms in order to further their use in building and make them fully acceptable to monitoring and insurance building services.

COURSES

In south-west USA, and more particularly in New Mexico, courses on adobe technology are run several times during the summer. The editorial team of "Abode Today" notably initiated a programme of several Summer Adobe Workshops. Amongst the most important workshops to be

run in the last few years the one organized by "Abode Today" and the Dal Al Islam foundation in the context of the construction of the Islamic village of Abiquiu (north-west of Santa-Fe) stands out. Hassan Fathy was invited in person to the workshop and was present for a fortnight accom-

panied by two Nubian master-masons who instructed the Abiquiu abode builders on how to build catenary vaults and domes on squinches or pendentives. In other parts of the world such accelerated or specialized training courses are quite exceptional. Recently France has seen the launching of short public training courses by ENTE at Montpellier, the ERSOL group, CAUE of Mont-de-Marsan and The National Mountain Park of Reims. In West Germany, at the University of Kassel, Eindhoven in Holland, Bokrijk in Belgium, various research groups have deve-

loped the concept of short courses accompanied by practical workshops. In France and abroad, CRATerre has participated in or directly organized courses on earth building in collaboration with ENDA of Ziguinchor in Senegal, Conescal in Mexico and Tlaxcala, and the Architecture Teaching Unit of Grenoble. The latter course at the School of Architecture in Grenoble (10 Galerie des Baladins, 38100 Grenoble) is run annually and consists in two distinct parts, each 3 weeks long, one theoretical and the other involving practical work on site.

PRESSES

The technological progress of earth construction is most apparent in the extraordinary extent of the development of presses. A great number of presses are now available on the international market. We give here some examples of new models which are most representative of current trends.

Note: *Bearing in mind that this type of material comes onto the market and disappears again at a frenetic pace and that certain manufacturers are real sharks totally lacking in scruples, including a list of addresses which would probably be out-of-date within a year would serve no useful purpose. For general information on production equipment, please contact CRATerre.*

The new manual presses which have been developed for the most part address various problems posed by the older versions. Hence an improved CINVA press, one by MEILI (hinged cover-plate), and one by BRE (manual com-

mands coupled with a hydraulic mechanism), etc. CRATerre Peru has recently designed a new press and opened a production workshop in the Andes region of Huancayo (see figure 339).

The TERSTARAM press is now available in a



FIGURE 339

motorized version, the SEMI-TERSTAMATIC. Its efficiency has therefore dramatically improved. The testing and running in of prototypes is now complete and the machines are being produced in their final form (more compact). This type of machine is extremely robust and has a simple mechanism allowing every-

FIGURE 340: PLATBROOD-BERGER EQUIPMENT

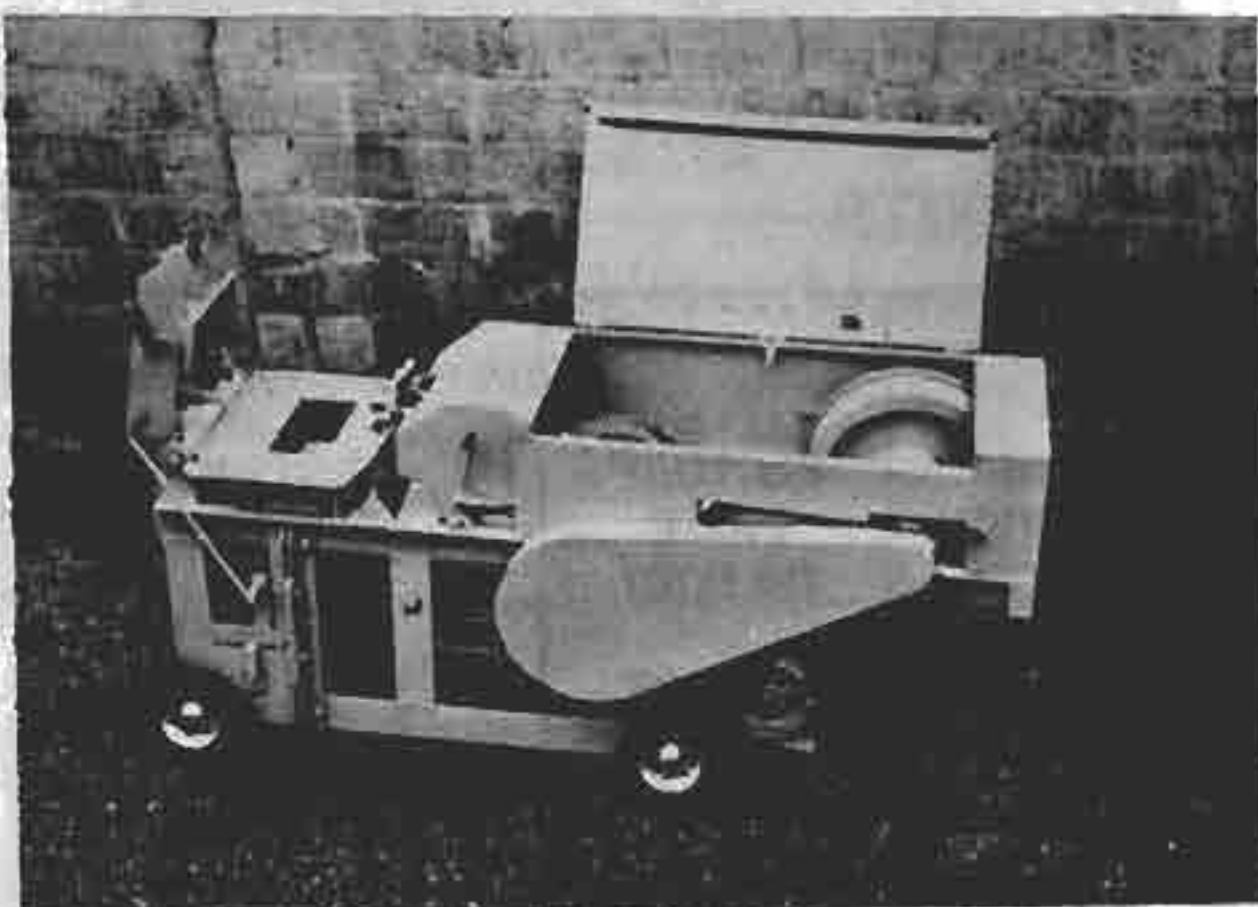

Platbrood F.

thing to be easily repairable in craft workshops.

Integrated mobile production units appeared on the market a few years ago. Sales of this type of equipment continue to grow as the concept is a very attractive one. In the USA and in France, this type of machinery is now available for hire. If all the optimum work conditions prevail, the number of bricks needed to build a medium-sized house (approximately 10,000 blocks) can be produced in 2 to 3 weeks. This major advantage is only really viable, however, in a precisely defined economic context and it is important to check its feasibility for each individual case.

In France, production of presses is at last attracting interest among manufacturers. The first prototypes meriting attention are on the

FIGURE 341: EARTH-RAM EQUIPMENT



Adobe Adobe.

testing bench and will be operational towards the middle of 1983. Small mechanical presses

FIGURE 342: "ATELIERS MEDITERRANEAN EXPERIMENTAUX" EQUIPMENT



Turquin.

(PACT 315) will prove competitive on the market.

The idea of complete production units has become a reality. These presses work, however, under extremely restricted economic conditions. The larger the units, the smaller the margin of usefulness. In most developing countries, this type of production unit (not all, thankfully) is not economically viable according to the feasibility studies which have been undertaken.

FIGURE 343: SOVEN PROTOTYPE EQUIPMENT

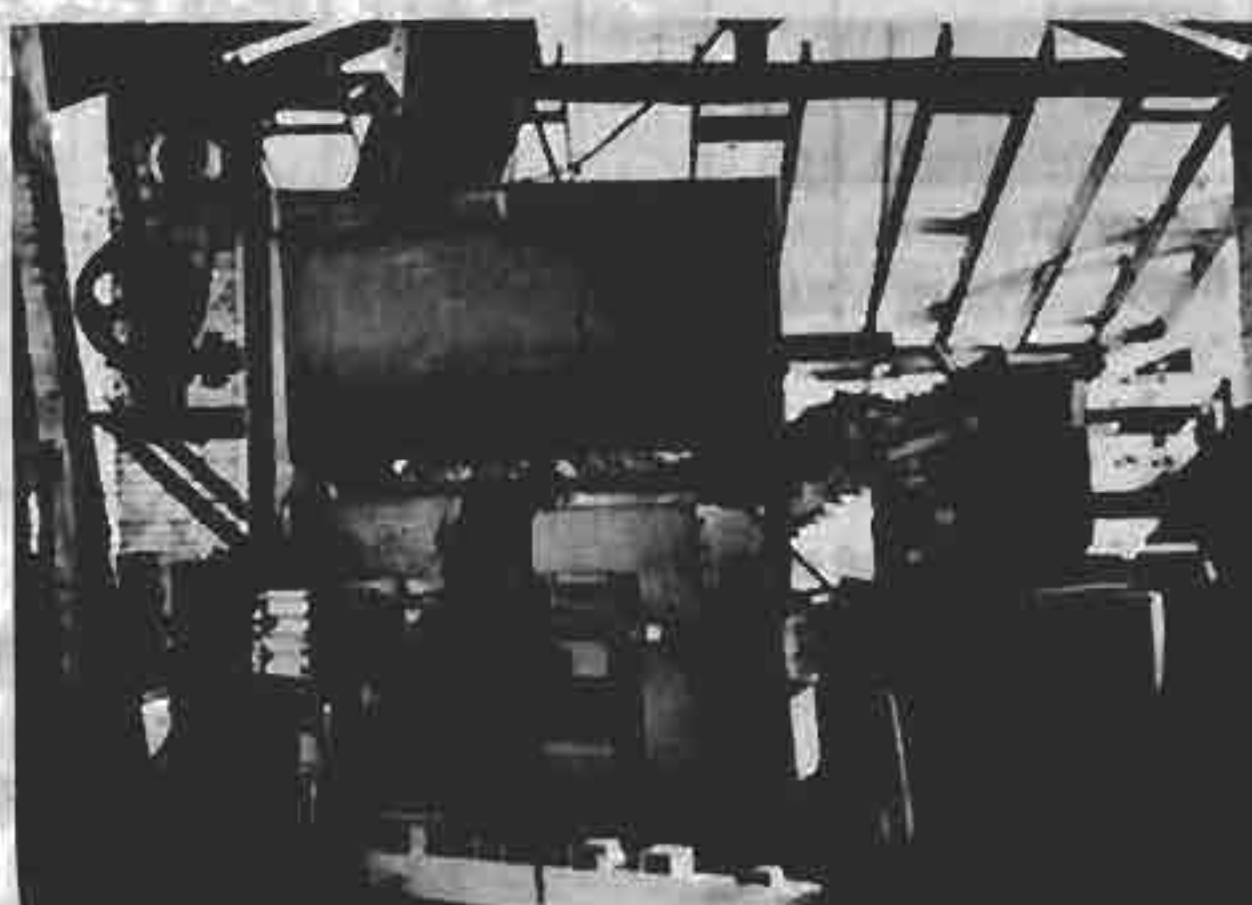

Colzani J.H./ARCHECO.

Complete industrial space-saving units are now available in various shapes and sizes. They are supplied ready for production but their economic viability should be closely studied if unfortunate experiences are to be avoided. Nevertheless, in realistic conditions, these machines can be very worthwhile. They are hydraulically powered, and they therefore need an appropriate technical environment to ensure a smooth operation.



FIGURE 344: TECMOR EQUIPMENT ►

RANGE OF PRODUCTION UNITS

TYPE OF INSTALLATION (TRADE-MARK) ★	PROTOTYPE OR PLANS	TESTED	FIXED UNIT	MOBILE UNIT	PULVERIZER	SIEWING UNIT	SWEING UNIT	PRESS	ANNUAL PRODUCTION CAPACITY	FACTORY PRICE OR FOB?	SYSTEM
									(BRICKS 29.5 x 14 x 9) ★★ ★★★	(NET OF TAXES, FF) ★★	
Cinva Ram Ellson Blockmaster		○	○					○	100 000 to 200 000	1 500 to 3 000	● Manual
Terstaram CRATerre Perou Pact 315	○	○	○					○	200 000 to 400 000	6 000 to 25 000	● Manual
Pact 315 motorisée Semi-Terstamatique	○	○	○					○	600 000 to 800 000	35 000 to 70 000	● Mechanic
MMH 2 000		○		○				○	750 000	85 000	● Hydraulic
Bernat-Saullere BG.2S CLU 3 000	○	○		○				○	250 000 to 1 000 000	70 000 to 120 000	● Hydraulic
Souen Soterem PPB RAFFIN	○			○	○	○	○	○	500 000 to 1 000 000	80 000 to 400 000	● Hydraulic ● Hypercompression
TECMOR HCR 3 HCR 5 ACCETTA		○	○		○	○	○	○	2 500 000 to 8 500 000	450 000 to 900 000	● Dynamic Compression ● Hydraulic Double-Compression
Latorex 13 Krupp	○	○	○		○	○	○	○	2 500 000 to 9 500 000	3 600 000 to 12 000 000	● Hydraulic ● Hypercompression ● Double-Compression ● Compensated Comp.

★ This list is not exhaustive.

★★ The figures given do not necessarily correspond exactly to the installation of this particular make. The make is given to allow the type of installation to be identified.

★★★ Production capacities are those given by manufacturers. In most cases they are completely theoretical and do not generally correspond to production rates obtaining on site, which are often lower by 50%.

RANGE OF PRODUCTION UNITS

	COMPACTION						
	STATIC			DYNAMIC			
	Manuel	Mechanical	Hydraulic	IMPACT		VIBRATION	
Manuel				Mechanic Hydraulic	Mechanical		
Simple press	○	○	○	○	○	○	●
Press integrated into mobile production unit	□	●	○	□	□	□	●
Press integrated into fixed production unit	●	●	○	□	□	□	○

○ Has existed in the past, currently exists or has been designed and will soon be on the market
 ● Interesting system but relatively little explored. Will probably be on the market before 1985.
 □ Appears to be of little interest.

EXTRUDED PRODUCTS

A new production technique has been developed in France by researchers of the INSA at Rennes and the CTTB. It consists in an extrusion process of alveolar unfired bricks or tiles. The earth is cement-stabilized with other less importance additives. All the normal ceramic industry equipment can be obtained. This technology is very similar to that of fired brick production, except that it omits the firing process.

Thus stabilized extruded bricks consume 50% less energy than fired bricks. The capital investment for the setting-up of a production unit is smaller and the break-even point is lower. The products are commercially available in France at prices between 7 and 10 % lower than those of fired bricks. The risk of frost-damage is still causing some problems, doubtless soon to be resolved.

PULVERIZERS

The study of the production technology of compressed blocks highlights the major importance of their preparation of the soil. Thus the finer the pulverization of the particles (up to a certain point!), the more efficient the stabilization. A whole range of pulverizers can therefore now be found on the market. Without a specially designed machine, the soil can always be pulverized with a tamper but this is a very laborious process. Machines to chop up waste material can also be used, similar to those available to shred garden waste; these machines should however be tried out before purchase as only the most powerful and robust models will be suitable.

Manual grinder derived from ground-nut grinders. This equipment works well for fine soils free of aggregates or from which aggregates have been removed. It is manually operated

(fairly hard work). Can be motorized on request. An illustrated example can be found on the following page (fig. 345).

FIGURE 345: PLATBROOD EQUIPMENT

Platbrood F.



Small motorized pulverizer. A squirrel-cage turns at high speed within a cylinder. The soil is pulverized on impact with the bars. This process often requires an additional sieving stage. The efficiency of the system can be increased by having two synchronized cages turning in opposite directions (figure 346).

FIGURE 346: TECMOR EQUIPMENT

Rodriguez I.M.

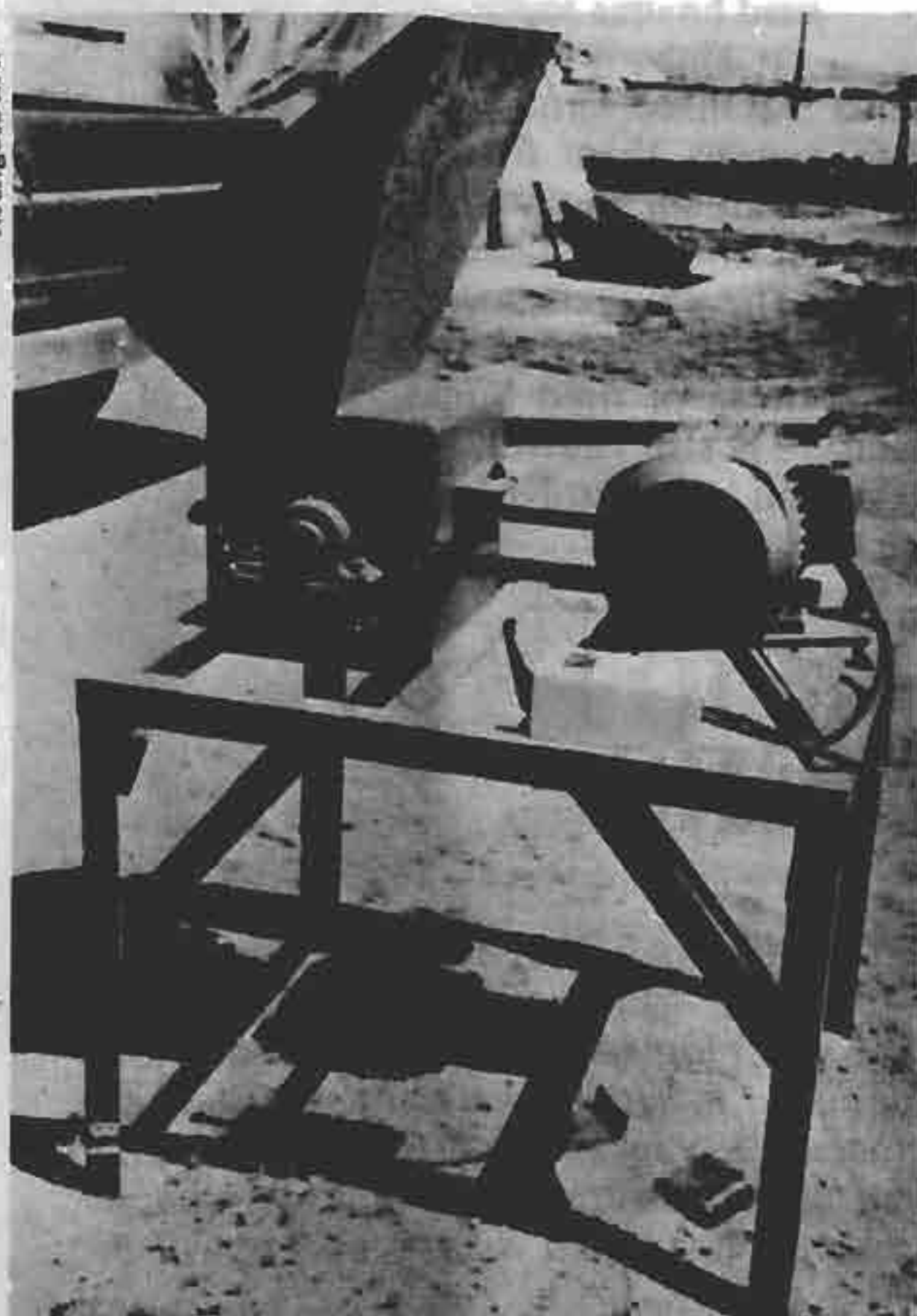

CARR system pulverizer. Two disks weighing 100 kg, each fitted with two series of bars, turn at high speed in opposite directions. The earth

is pulverized between the two. This model is available manually operated (very laborious to use) and motorized (figure 347).

FIGURE 347: PLATBROOD EQUIPMENT

Platbrood F.



Propeller pulverizers work in a very simple and efficient way. A whole series of propellers can be fixed onto the axis. Another process consists in shredding the earth with a conveyor belt studded with dipped steel prongs which turns at high speed. This system is particularly suited to pulverizing wet earth (Royer).

FIGURE 348: CONSOLID EQUIPMENT

Consolid.

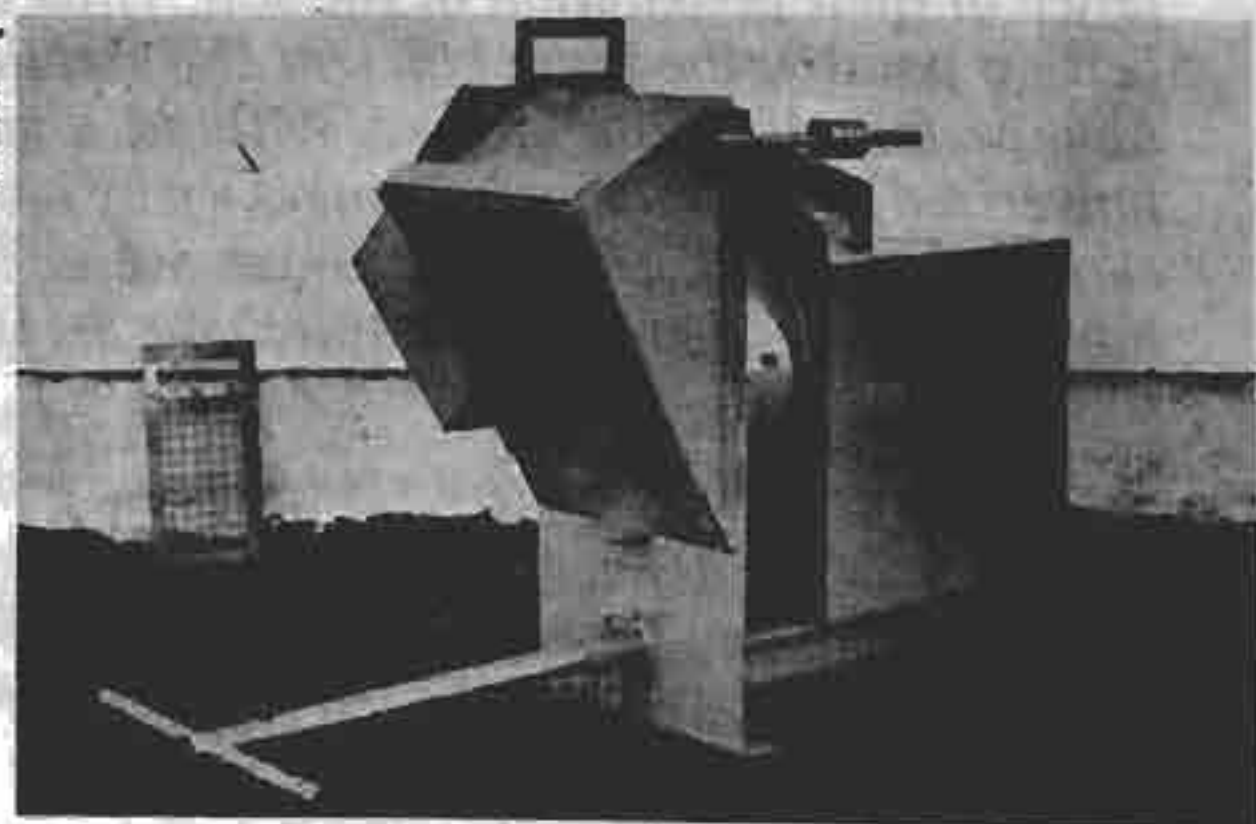

MIXERS

One of the main stages in the chain of production of earth materials is good mixing. For compressed blocks or rammed earth, the turbomixer remains the most viable machine. The turbomixer is widely known but does not solve the problem of finding small low-volume mixers fitted with thermal motors.

A small range of very attractive free-standing turbomixers is commercially available. These can be bought in different versions, fixed or mobile, with or without hopper, with electric or thermal motor.

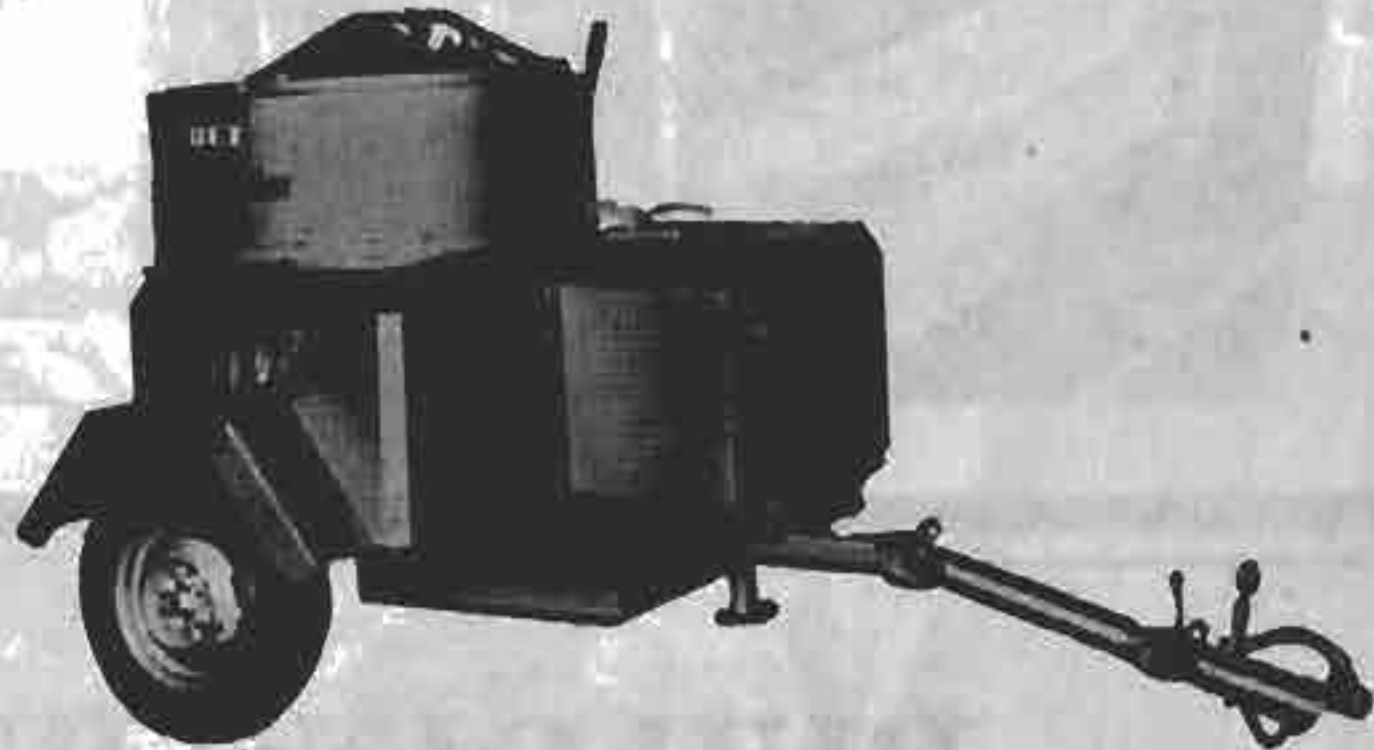

Uez, Lecha.

FIGURE 349: UEZ EQUIPMENT

With regard to our chapter on Mixers, it has emerged that we were not sufficiently specific. We therefore append here some important additional comments.

- The installed power of a diesel motor will always be at least 1.5 times greater than that of an electric motor.
- For "dry" earth, a horizontal blade mixer will need at least 1 HP diesel per 10 litres of earth volume introduced. A tur-

bomixer will need at the most 3/4 of this power.

- For "dry" earth, a horizontal blade mixer will have to be extremely robustly made.
- More and more firms and owner-builders are using motor-cultivators. They are efficient and not too expensive, easy to maintain and above all usable for other purposes after building work is complete.

FORMWORKS

The types of formworks which have been used are as varied as they are numerous, depending on geographical, technological and historical circumstances. With the revival of rammed earth, two types of formwork reappeared, one for horizontal displacement of the shuttering (the traditional French system, for example), and the other for vertical displacement (Australia and USA).

Light formwork for horizontal displacement. Prototype developed by "Terre et Soleil", France. This formwork, still in the development stage, represents one point in the search for a contemporary adaptation of an outmoded traditional technology (figure 350).

Vertical displacement formwork. Sections of wall are built and then linked together by con-

crete posts, inset bays, doors, windows or simply dilation joints. The lower part of the formwork is moved up before the top of the second part of the formwork is reached. This avoids the problem of horizontal joints. This system is fairly widely used in the USA, (see Figure 351, following page).

FIGURE 350: "TERRE ET SOLEIL" EQUIPMENT

FIGURE 351: MILLER-REH EQUIPMENT

Gumbau, J. Terre et Soleil.



Miller D. et L., REIL.



BUILDING WITH EARTH IN PERU

At the end of 1979 when the first edition of this book had appeared (in French), our main ambition was to put the work it synthesized at the disposal of the underprivileged populations of a country built with earth.

Three of the founder members of CRATerre resolved to take up the challenge. Overcoming many administrative hurdles and thanks to the support of European non-government organisations as well as the French Ministry for External Relations, the team set off in February 1980 for Peru.

For the past three years we have been based at the observatory of the Geographical Institute of Huayao, near Huancayo, at an altitude of some 3,000 m in the heart of the Andes Cordillera. We have created a Technical Support Network: a structure capable of undertaking effective work directly with the peasant communities of the Andes. Our researches and studies aim to improve earth-built housing in liaison with official organisations such as the National Institute of Research and Standardization of habitat (ININVI, formerly OIN) and the Geophysical Institute of Peru (IGP) which can ensure that the results obtained are nationally disseminated.

Our main objective is to further the reappraisal of local knowledge by bringing to it new technological elements in the field of earth construction. Our interventions are such as to create a new set of relationships between technicians and local people, gradually to break down the barriers between the "Technico-Scientific" world and that of "Local knowledge

and Tradition". Thus we have deliberately chosen not to develop technological systems which might give excellent results in the laboratory but which would not have evolved from a real understanding of the major problems to be tackled and above all which would not be tested and debated from the very first by the peasant community. This approach is bound to take time, since we have to know in detail not only the thinking of the Andes peasant when he builds, but also the social organisation which governs his life, and the technological problems which endure as well as those which are not relevant. An exchange of knowledge is indispensable. We have to learn before we can advise.

The production and control of their own environments must remain in the hands of the local people. The peasant communities of the Andes have managed to preserve over the centuries their original system of mutual help; the existence of this system remains to this day an essential ingredient for survival. Earth as a

building material is one of the many elements which still promotes social cohesion. With the incipient infiltration of conventional materials (bricks, concrete...) the collective system is under threat: the "monetary" system is taking root. The peasant wishing to build his house in "noble" materials will have considerable difficulty in rallying the village community to his aid. He may have been able to pay "dear" for

these materials, but he will also have to find the price of a mason and his helpers. Earth itself is not for sale: it belongs to the place just as the people themselves do.

We have chosen two examples illustrating the way we work. The first is the construction of a medical center at Colpar; the other that of an agricultural warehouse at La Punta.

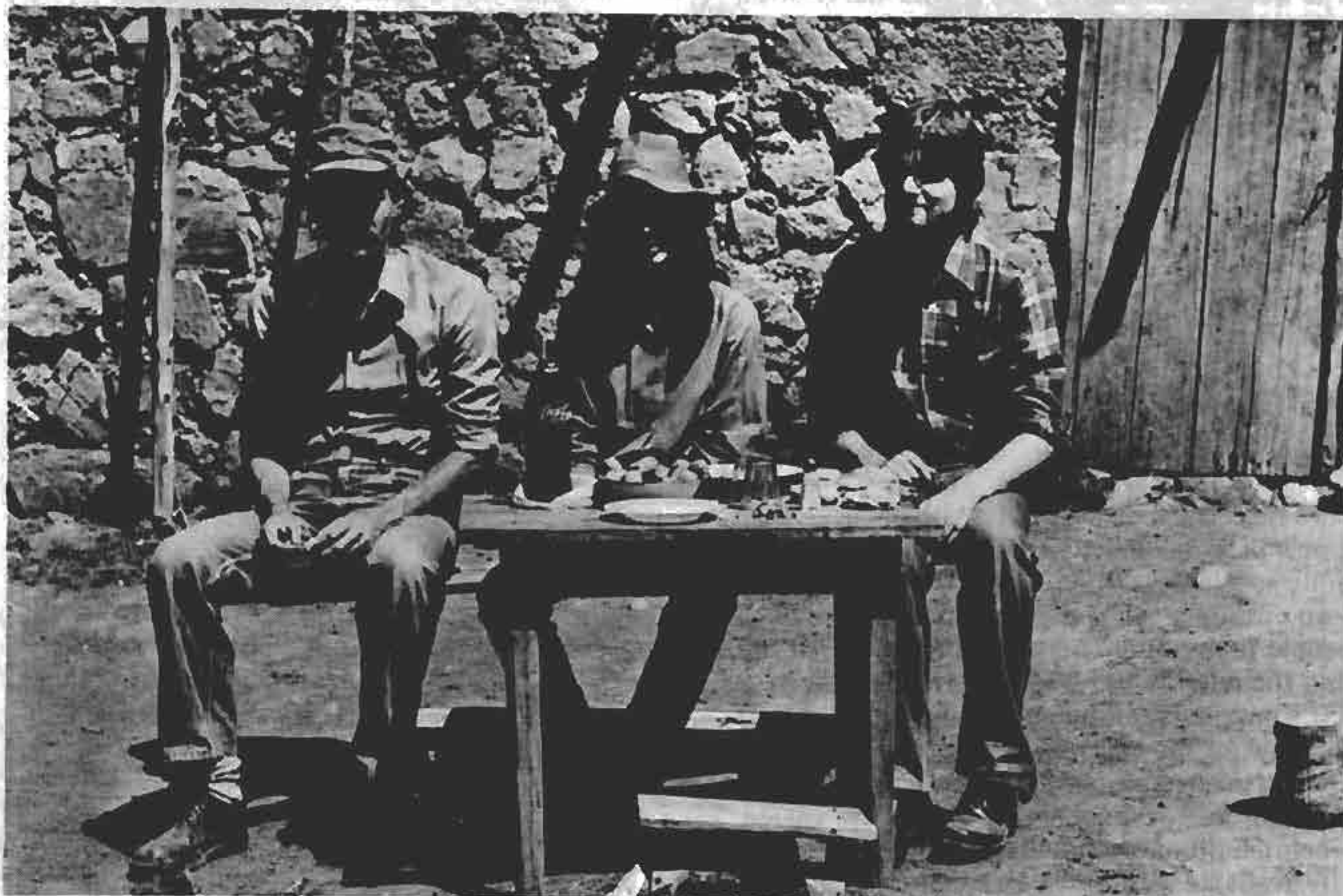

CRATerre Pérou

FIGURE 352: IN THE HEART OF THE ANDES CORDILLERA SINCE 1980: FRANCOIS VITOUX, SILVIA MATUCK, ALAIN HAYS.

A medical center in compressed earth blocks: the introduction of a non-traditional technology

The 70 families which make up the peasant community of Colpar, in the Huancayo zone, live mainly by agriculture (subsistence). They own small plots of land on which they cultivate potatoes, maize, wheat etc. One section of the population lives by raising animals (cows, horses, sheep, lamas, alpacas) and by craft textiles. A significant proportion of "young people" get jobs as miners in the area. The term "community" is used to designate a "village" with a particular legal status which gives it a certain degree of freedom in its activities. This autonomy is generally linked to a very strong group

consciousness. The community spirit is seen at its most spectacular in the "faena".

Communal work or the "faena" has its roots in pre-Inca tradition: the whole community comes together for major works of common benefit: road maintenance, irrigation ditches, the construction of public buildings. "Faena" days are compulsory. Any "comunero" who cannot attend will have either to find someone to stand in for him from his own family, his wife or one of his children (girl or boy over 16 years of age), or to pay a fine in money or in kind.

What work is to be done and which days are declared faena is decided by a simple majority of the comuneros present at meetings. Community officials assume responsibility for organizing the work. Individual building work is sometimes based on a mutual help system similar to the faena and can involve - according to the owner's standing - over a hundred people, friends, family and neighbours. The owner is duty bound to provide music, meals and drinks. It is not uncommon to see a reasonably sized house (sometimes with a first floor) "grow out of the earth" in a single weekend. It was thanks to the faena that the medical center of Colpar was to be built.

The decision process: the idea of providing the community with a medical center originated with the authorities. CRATerre's team declared

itself willing to assume technical responsibility, which left the need to discuss it in a general meeting and agree on the approach. On the appointed day the comuneros came to the meeting, the project was explained, and each gave his opinion. Views were divided, and a problem emerged: the rainy season was approaching and it was a practical impossibility to produce adobe bricks before the first rains. One comunero, however, recalled that the first time he had met a member of the team the previous year, he had seen a presentation of the various ways of building with earth and that there was a technique, compressed earth blocks, which posed less of a drying problem. This option was put forward and debated. Put to the vote it was accepted and two days of faena per week were agreed. Whether for or against, all had to bow to the majority decision.

Producing a new press: the search for a suitable tool

In response to demand, the idea of developing a new press emerged. This tool needed to meet quite specific demands, in particular:

- an output capable of matching the work of 15 people (extracting and preparing the earth, filling the moulds and removing the blocks);
- the possibility of the producing special shapes to allow for the masonry to integrate horizontal and vertical reinforcing elements (earthquake-resistant features);
- being built of components which were regionally available with a view to enabling small craft or semi-industrial production if it proved a success.

There being no press on the market which met these requirements, we had to innovate. A wooden scale 1 model of the prototype was made in order to allow us to subject the working principle we had chosen to careful analysis.

One of the members of our team then built the first prototype of the press in the workshop of the IGP observatory. The tools used for this were very simple: a drill, a welding area, a grinding wheel and a small bench lathe. All the metal was cut by hand. The use only of metal profiles (corners, flat irons and tubes), each of the same size, simplified production and minimized errors resulting in an economic unit production.

CRATerre Pérou

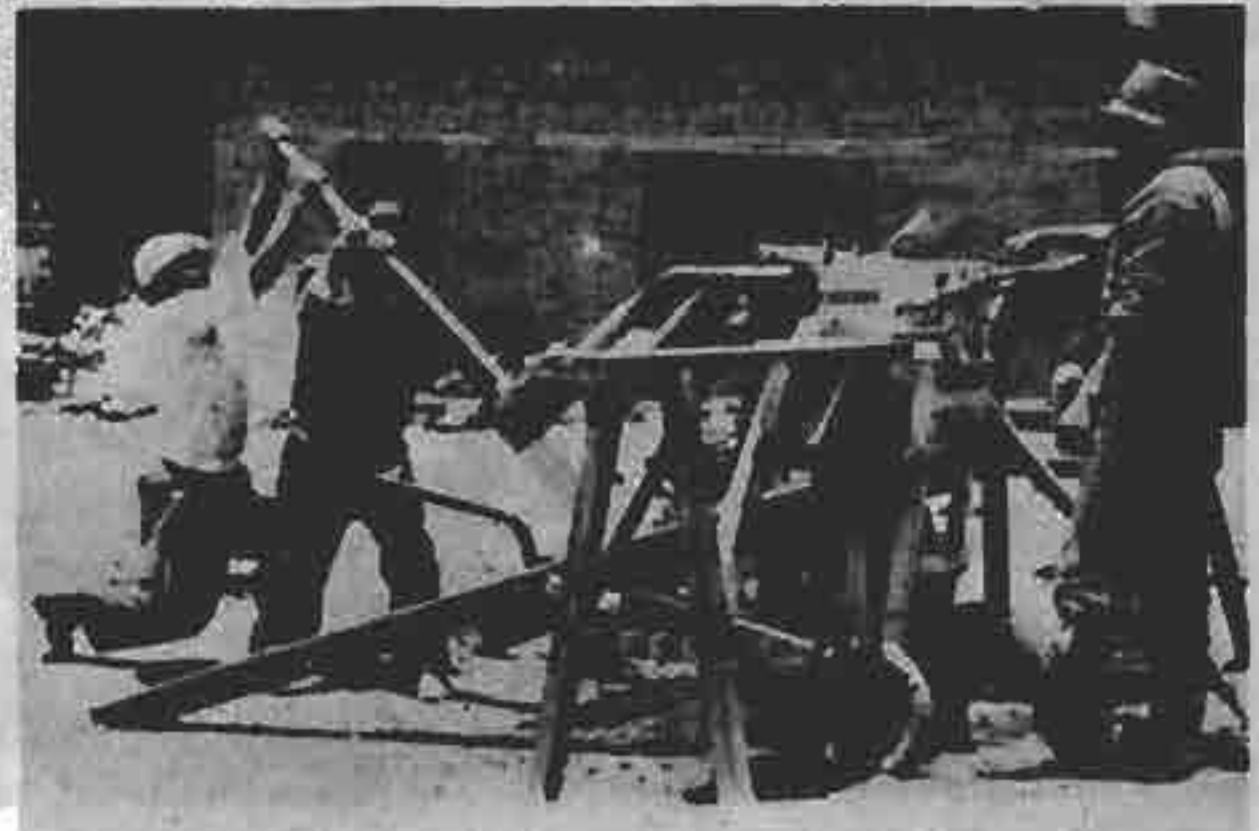

CRATerre Pérou



FIGURES 353 AND 354:
PRODUCTION OF 5,500 BLOCKS
WITH THE "CRATerre"
PRESS; PEASANT COMMUNITY OF
COLPAR. LOWER PHOTO: DETAIL.

THE "CRATERRE" PRESS: SPECIFICATION

CRATERRE Pérou

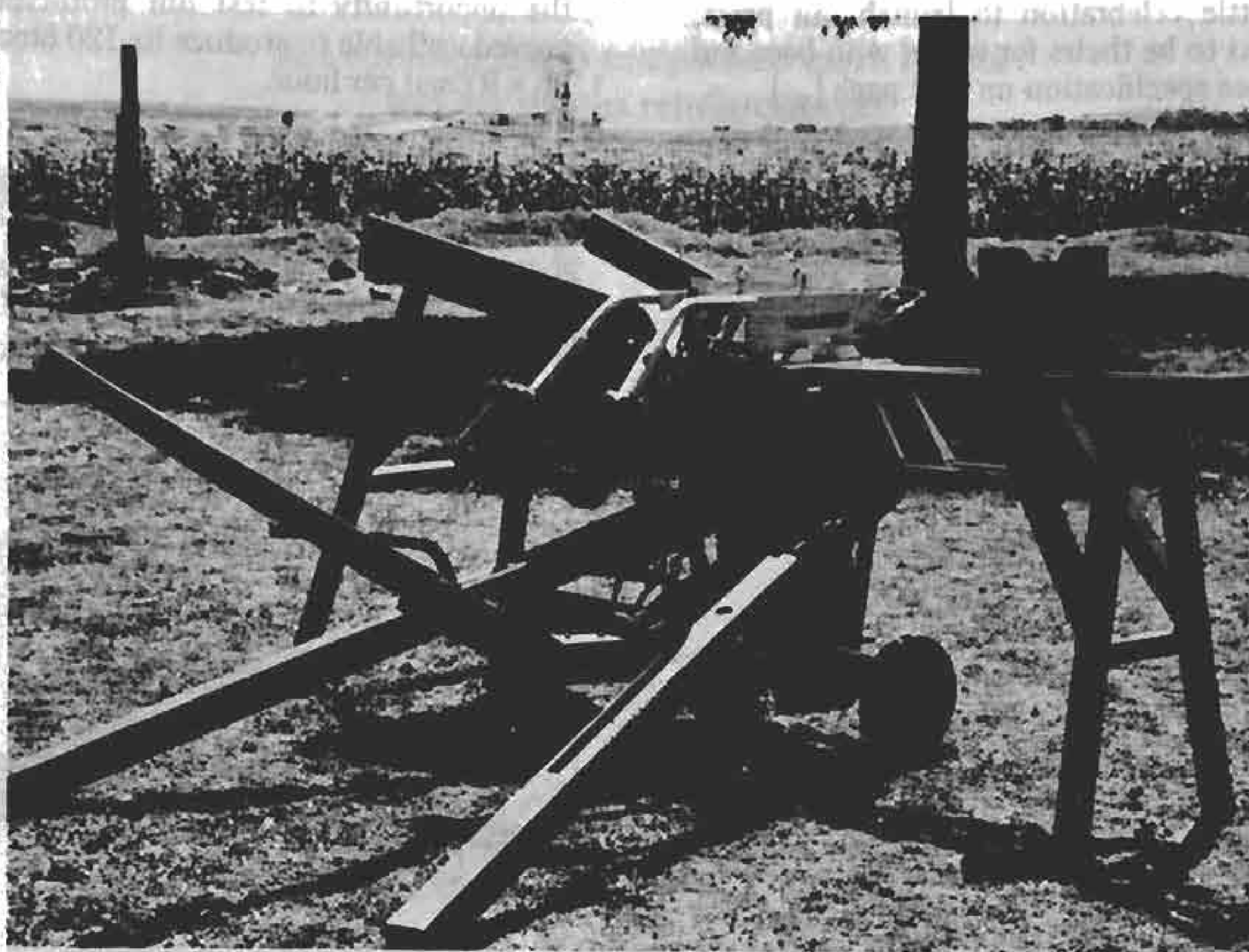

- *Static pressure manual press.*
- *Filling mould-box, automatic raising of cover-plate and emptying mould-box results from lowering the lever in one smooth continuous movement.*
- **Dimensions:** *press alone: Length = 230; width = 163; height = 124. Fully equipped press: length = 230; width = 280; height = 124.*
Weight: *press only: 230 kg; press fully equipped: 280 kg.*
- **Compaction pressure:** *15 to 20 kgf/cm².*
- **Compressive ratio:** *1.67.*
- **Maximum mould-box depth:** *160 mm.*
- **Maximum plate travel:** *70 mm.*
- **Block sizes:** *variable - interchangeable moulds: 1 block 28 × 28 × 8 cm; 1 block 28 × 28 × 8 cm with lateral groove; 2 blocks 28 × 12.8 × 8 cm; 2 blocks 28 × 12.8 × 8 cm with lateral grooves.*
- **Number of blocks/hour:** *120 blocks 28 × 28 × 8 cm.*
- **Daily possible compacted volume:** *4.23 m³.*
- **Number of operators:** *minimum 2 to 3.*
- **Maintenance:** *oiling ??*
- **Accessories:** *1 table holding 60 kg of earth; 1 table to remove blocks; 10 plywood boards to transport the freshly compacted blocks for each type of mould.*

This press was patented in 1982.

While they were waiting for the "machine" the Colpar community dug the foundations and built the footing of the medical centre. On the day of its inauguration, the community organized a little celebration to launch our press, which was to be theirs for while, with beer and chicha (see specification on that page [...]).

The comuneros very quickly grasped the way the press worked and the 5,500 blocks needed gradually piled up in the church which served as a depot as the faena days allowed. This gave us the opportunity to test our prototype which proved well able to produce its 120 blocks (28 × 28 × 9 cms) per hour.

FIGURE 355: BLOCK PRODUCTION WITH THE "CRATerre" PRESS

- a) Bringing moist earth to the press. The women carry 15 to 20 kgs of earth at a time.
- b) Another woman at the end of the work-bench helps unload the earth.
- c) The press mould-box is filled, and the cover-plate closed. When the block has been compressed the same worker slides it to one side on the work-bench.

- d) Operating the lever handle in order to fill the mould to compress, open the cover-plate and eject the block.
- e) Carrying the blocks to the drying and storage area. (Each block of 28 × 28 × 9 cm weighs 12 kg).

CRATerre Pérou

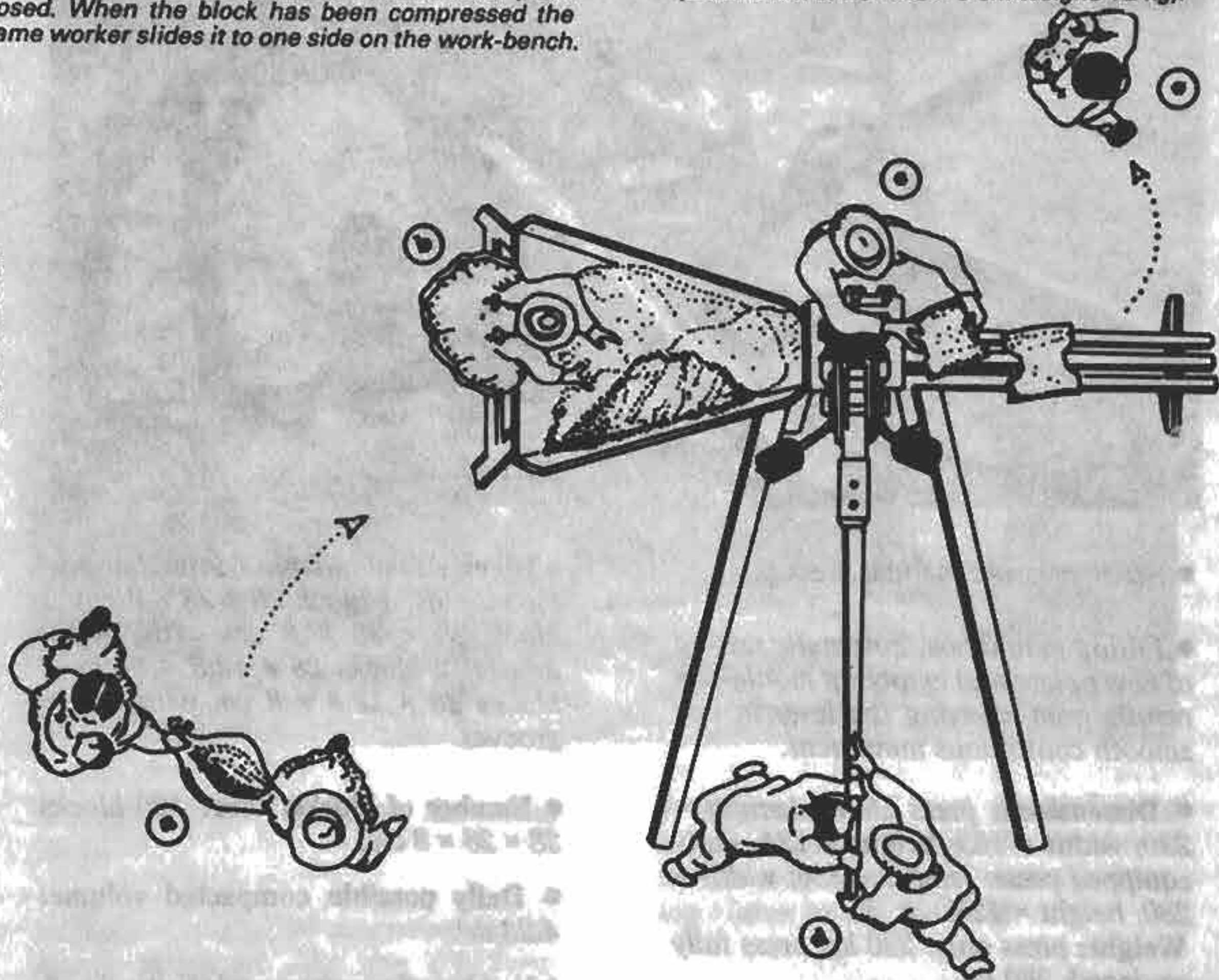

A typical faena day

A faena day at Colpar starts at about 9 in the morning, once the children have gone off to school, the morning household chores have been done and the animals driven to pasture. The comuneros assemble on the main square where they wait for the village officials. After a few details of the work to be done have been gone over, the work starts and goes on till the middle of the morning when a break is allowed.

Coco-Cola and a bottle of spirits are passed round (paid for by the fines of those who have not appeared). The faena goes on till midday.

Another break and more Coca-Cola and spirits, while the women produce from their "mantas" a little grilled maize and cooked potato which they share with their children as their meal. The men talk amongst themselves without eating.

Work starts up again and generally finishes around 4 in the afternoon, when a meeting is held to discuss the next faena day and any

community issues. The decisions put to the vote are scrupulously recorded in a register by one of the officials.

The building stage: compressed earth blocks and eucalyptus reinforcements

As earthquakes are a permanent risk in the Andes Cordillera, it was essential to use a particular building system with the earth blocks

produced. The medical center was designed around the findings of ININVI experimentation on adobes and "canas". Putting up a building in

SPECIFICATION OF THE MEDICAL CENTER

CRATerre Pérou



- **Foundation - footings:** flat stone masonry.

- **Walls:** Unstabilized compressed earth blocks produced with the CRATerre press. Stabilization restricted to the first two courses: a lime-cement mix.

- **Vertical reinforcements:** young eucalyptus trees of approximately 5 cm in diameter.

- **Horizontal reinforcements:** Wood bundles 2.5 x 2.5 cm held together by 3 mm ϕ irons.

- **Mortar:** same earth as the blocks.

- **Tie-beams:** 9.5 mm ϕ reinforcing bars in a cement mortar, the number of horizontally reinforced courses increasing higher up the building.

- **Lintels:** eucalyptus beams.

- **Roofing:** Traditional roof structure in eucalyptus beams squared with an adze.

Under-roof in "quinual" branches (local shrub).

Covering in locally produced semi-circular Roman tiles.

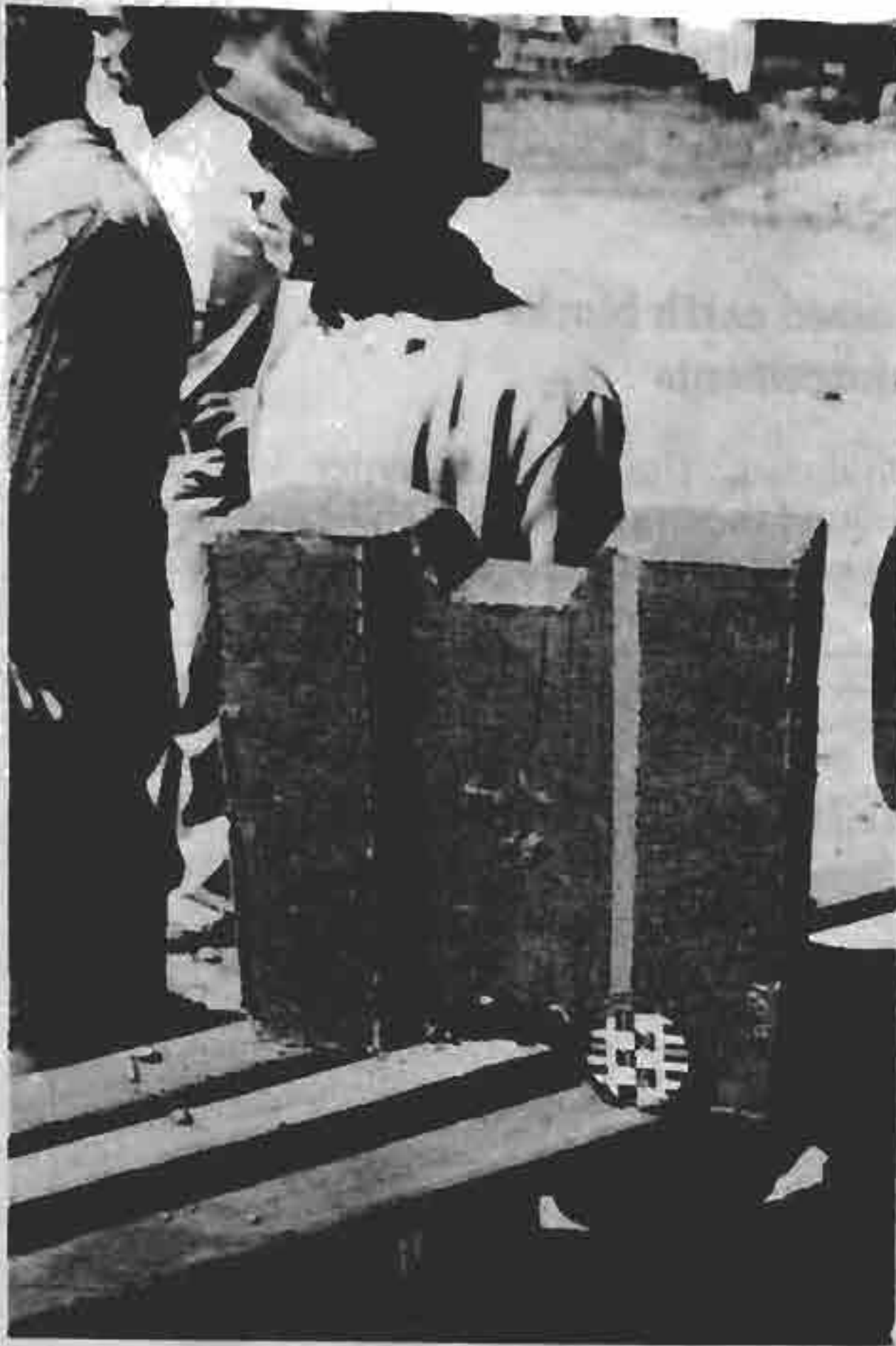

FIGURE 356: FRESHLY MADE COMPRESSED EARTH BLOCK

Its special shape allows to incorporate in the masonry, vertical and horizontal reinforcements.

accordance with earthquake resistant recommendations (see pages 131, 132, 135, 136) is not too easy for a group of non-professional builders. The community was determined to overcome any problems. The foundations, given the sloping site, had to be stepped; the footing was built in stones roughcast in an earth mortar - far from the best solution, but the cheapest. The buttresses at each corner complicated the plan of the building as well as the bonding pattern.



FIGURE 359: COLLECTIVE WORK AMONGST THE PEASANT COMMUNITY OR FAENA: An andes tradition still very much alive

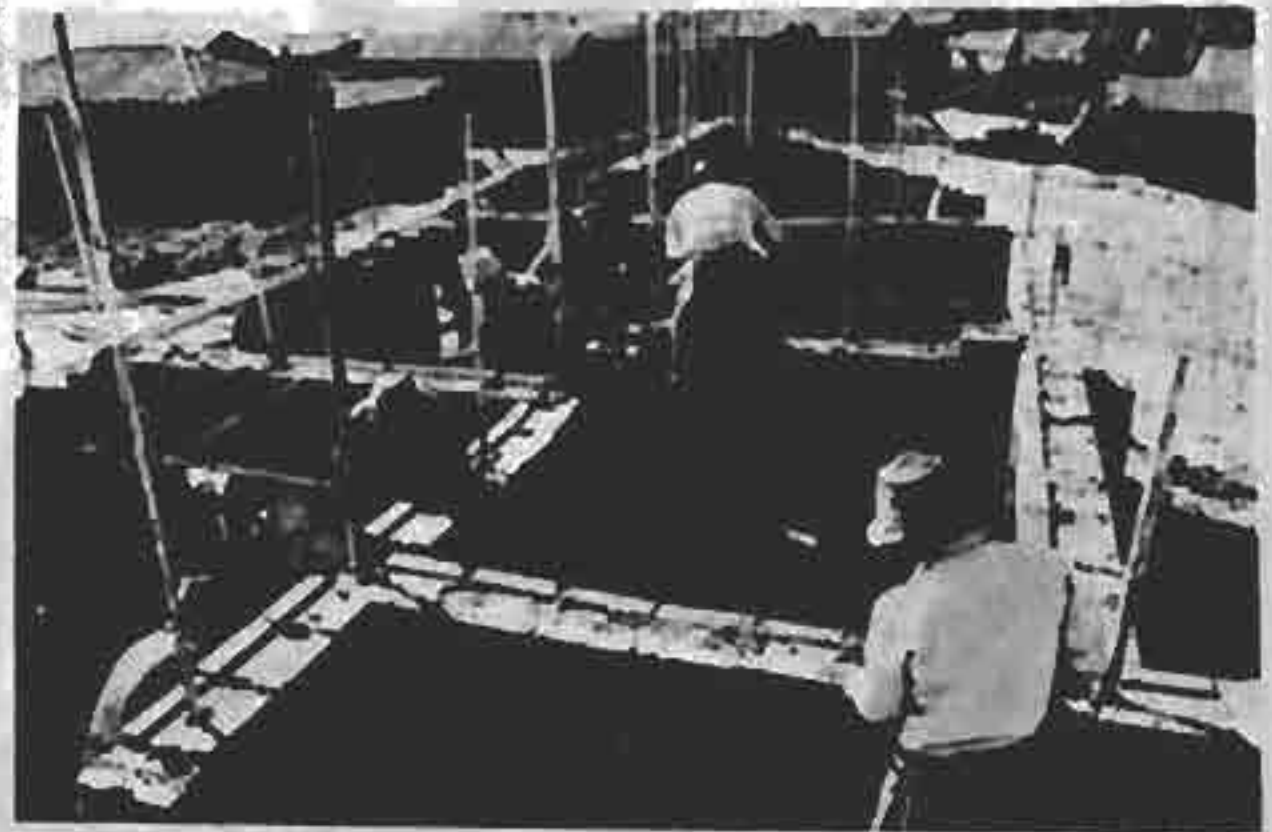

FIGURE 360: MASONRY IN COMPRESSED EARTH BLOCKS REINFORCED WITH EUCALYPTUS WOOD. Careful work, carried out by non-professionals.

ern. The first two courses were in lime- and cement-stabilized blocks to improve the ability of the building to withstand any rising damp. Eucalyptus wood, which is very widespread in the area was used for vertical reinforcing and lintels provided horizontal reinforcing "tie-beams" every 4 courses. The special shape of our blocks made it much easier to incorporate these reinforcements. The experimental nature of the work made the comuneros all the more diligent

FIGURE 357: DIMENSIONS OF "SPECIAL" BLOCKS; WHOLE BLOCK AND HALF-BLOCK

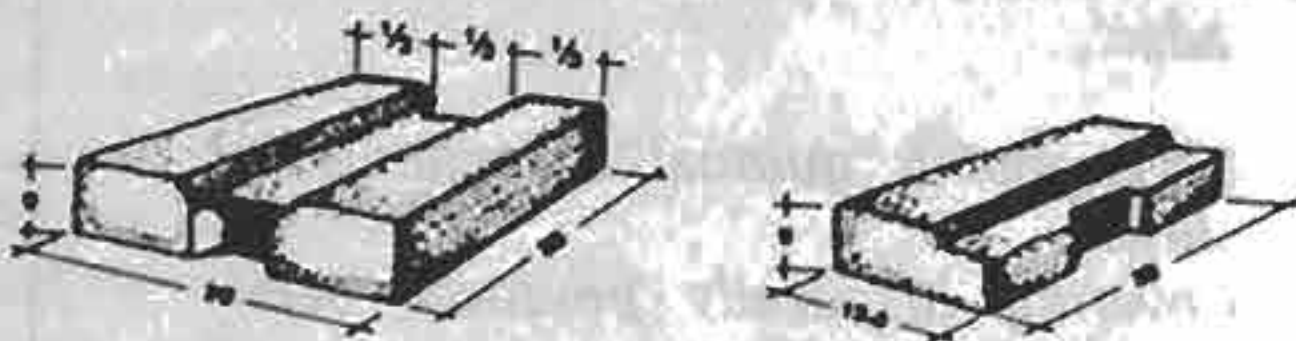

FIGURE 358: HOW TO INCORPORATE VERTICAL AND HORIZONTAL REINFORCEMENTS WHILST KEEPING A GOOD BLOCK BONDING PATTERN.

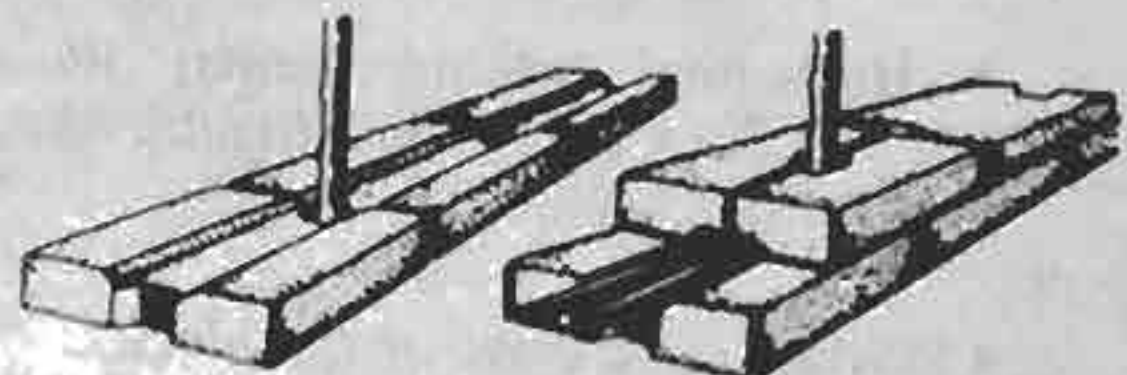
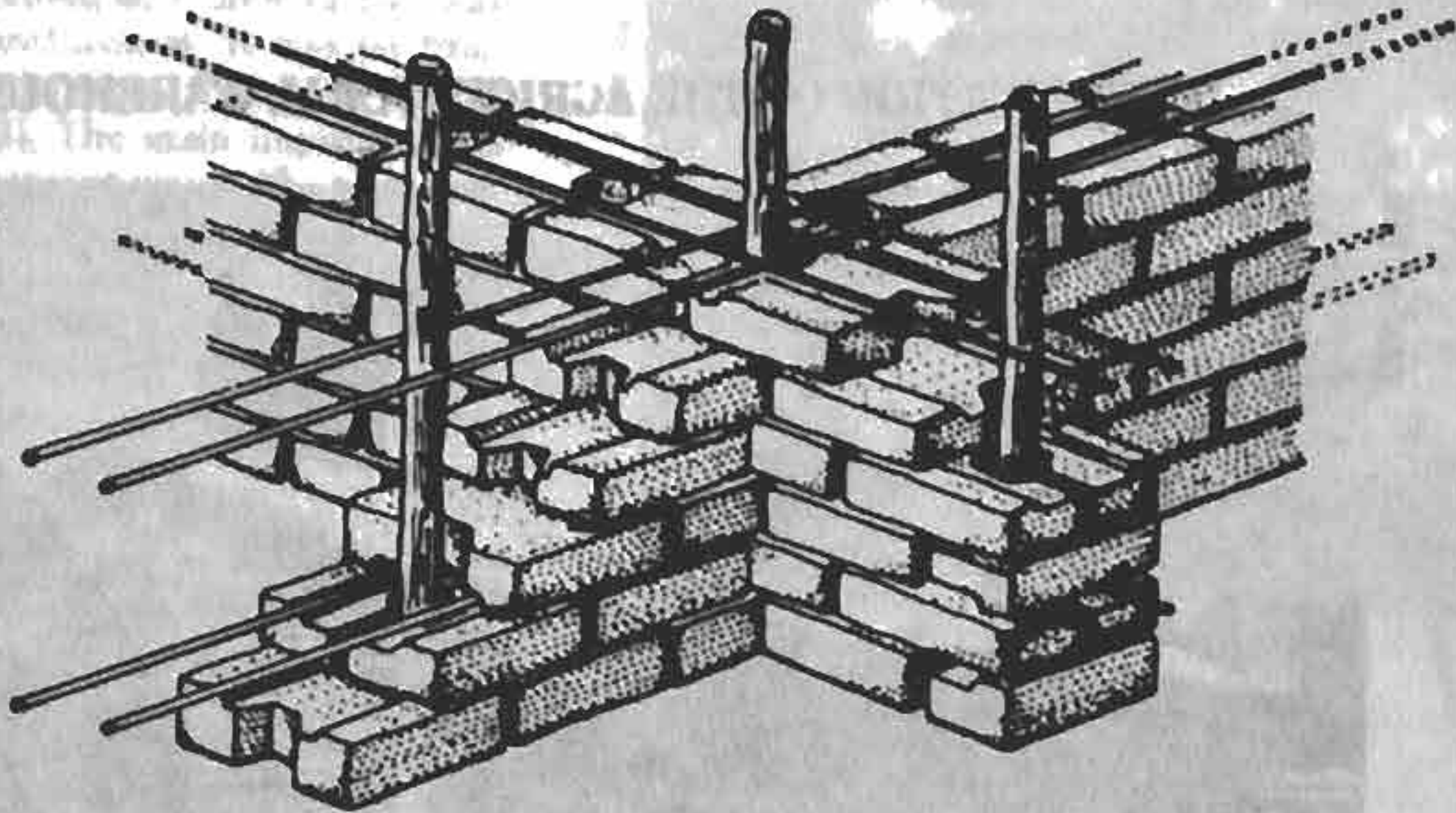

FIGURE 361:
REINFORCED
EARTH BLOCK
MASONRY:
JUNCTION OF
TWO WALLS.



and proud. One of the factors leading to the success of the operation was the attitude we had decided to adopt during building work. The scale of the changes required in local building habits and the determination to use the traditional system of organisation ran the risk of posing insurmountable problems: either we would be cast in the role of "foremen", which the comuneros committee could not have accepted; or the technological changes which went against tradition would be rejected. The first obstacle was removed by allowing the community total freedom in how to organize the site work. Any attempt to change the work organisa-

tion, given that the men always undertake the most glamorous jobs (operating the press, putting up the walls) whilst the women are left to carry materials, would have been very badly received and rejected. In order to resolve the second problem, and ensure that the technological changes were understood, it was essential that the team to be permanently represented on site on each faena day. New solutions were explained often by demonstration then debated. Modifications could be improvised on site and in the final event the comuneros meeting had the right to veto.

La Punta: An adobe agricultural warehouse: improving a traditional technology

For the Andes people, who have a tradition of building with adobe bricks and rammed earth, changing the way in which bricks are produced by using a press and modifying the normal building system is in effect equivalent to introducing a new building material. The construction of a cooperative potato warehouse in La Punta was to pose the dual problem of modifying the shape of the adobe bricks, and introducing special building elements.

The building enabled the application of an audio-visual training course using video, pre-



FIGURE 362:
FILLING ADOBE
MOULDS THE
"WATER IMPACT"
WAY, LA PUNTA.

SPECIFICATION OF THE AGRICULTURAL WAREHOUSE

CRA Terre Péru

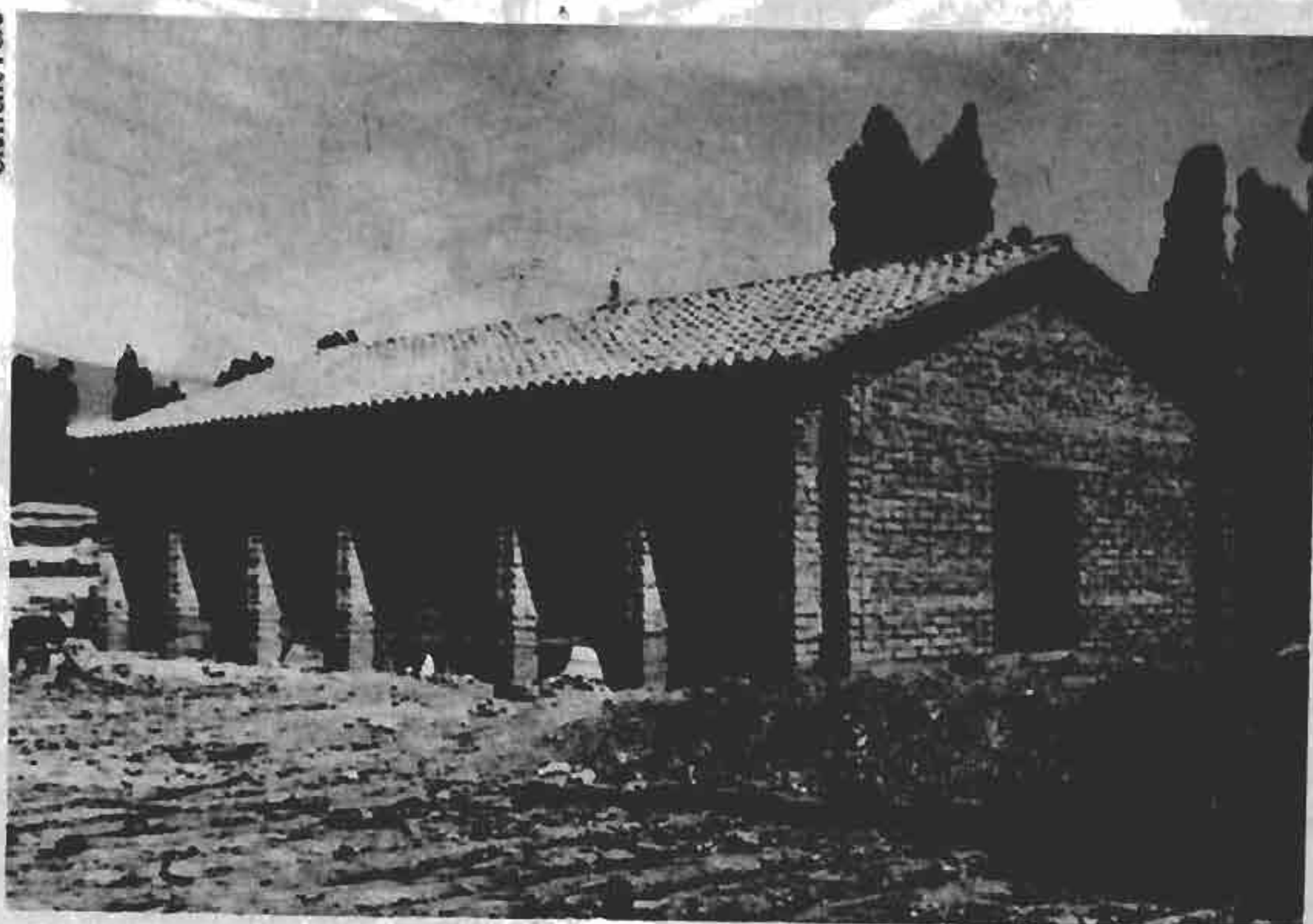

Foundation: in cyclopean concrete.

● **Footing:** in cyclopean concrete, with ventilation holes.

● **Lintels for ventilation holes:** reinforced concrete.

● **Walls:** in adobe $40 \times 40 \times 10$ cm reinforced by masonry buttresses. Height: 3 m. Gable-ends: 4.75 m.

● **Door and window lintels:** Eucalyptus rafters.

Ring-beam: Eucalyptus rafters.

Roof covering: traditional quarry tiles.

Special features: ventilation through 10 air-vents 1.2×0.40 m moistening the air thanks to two containers 1.80×7.20 m and 20 cm deep.

Potatoes stocked on ventilated wood floorboards.

pared by CESPAC and ININVI. The course was intended to give a theoretical and practical introduction to adobe masonry and facilitate the dissemination of the suggested building system (see p. 136). Some twenty comuneros and cooperative members - men and women who were not professional builders - decided to chance it.

In the first place the blocks had to be made square ($40 \times 40 \times 10$ cm). Their weight (approx. 24 kg) meant that they had to be moulded in the traditional way on the ground in a bottomless mould (see p. 113). The earth was mixed at least one day ahead with straw and water until it reached the consistency of mud. The change in

dimensions of the adobe block (those of the Huancayo area measured $40 \times 30 \times 12$ cm) was not met with any enthusiasm. It was far from obvious to the participants that such blocks could be made at all. The main improvements the average Andes peasant would like to see are as follows:

- easier work (particularly mixing);
- higher output for the same amount of work;
- obtaining a material with a more "noble" appearance.

To a large extent this is what we achieved with the compressed earth blocks. At La punta it was more the behaviour of an adobe building in a possible earthquake which was called into question. But this was a secondary consideration as far as the comuneros, who had to be convinced, were concerned. A hundred tonnes of potatoes for consumption had to be stored in the 16.80×9.20 m building. Starting from the recommendations of the C.I.P (Centro Internacional de la Papa-Huancayo), we had to think up a natural ventilation and refrigeration system through moist air circulation. The structure of the warehouse was designed according to the reinforced masonry principles described on page p. 136. This experimental warehouse was to serve as a model for the World Food Programme: 10 similar buildings in adobe (slightly) were built by peasant communities in the regions of Apurimac, Huaraz, Caraz, Huanuco, Lta, Junin, Puno and Cuzco.

On page 272 we reproduce one of the pages of our site note-book showing the work organisation of the comuneros as the walls were going up.

Building with earth in Peru is not subject to passing phases: it is a frequently hard reality for millions of Andes comuneros. We continue to give our support to peasant communities. Our center has available a stock of tools which can be borrowed and complement the 10 or so presses currently being built.

Mindful of our objectives we hope that the communication network between the various groups and organisations involved which already exists in Peru, in the countries of the Andes and at international level will grow stronger: the Technical Support Network we run is one link in the chain of exchanges to



FIGURE 363:
A YOUNG "COMUNERA"
CARRIES UP THE EARTH MORTAR
FOR THE ADOBE WALLS OF
THE AGRICULTURAL WAREHOUSE.

which readers are invited to contribute from their own experience and knowledge.

Huayao, 25th November 1982.

CRATerre's projects in Peru are supported by:

- C.C.F.D. (France)
- Ministry of External Relations (France)
- Agro Accion Alemana (West Germany)
- Trocaire (Ireland)
- Vastenaktie (Netherlands)
- C.I.M. (Switzerland)
- UNESCO

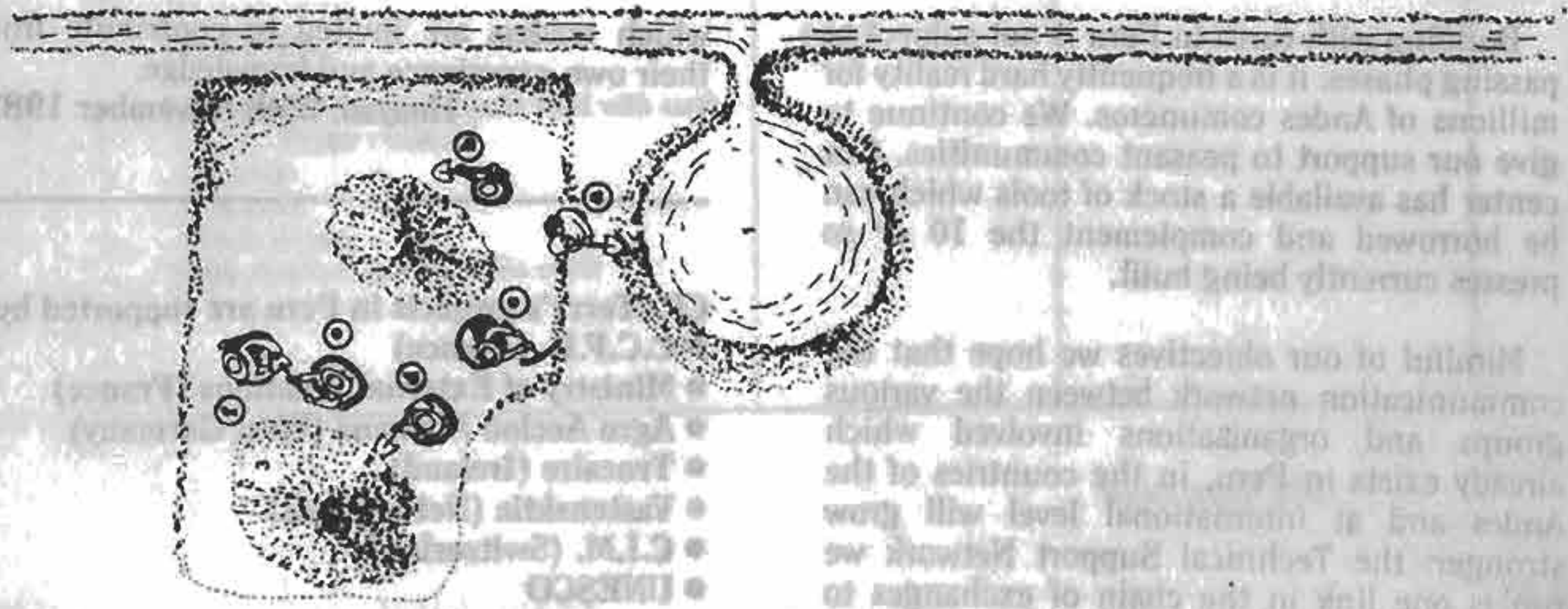

FIGURE 364 AND 365:
CONSTRUCTION OF THE
AGRICULTURAL WAREHOUSE,
ORGANISATION OF COLLECTIVE
WORK OF THE COMUNEROS OF LA PUNTA,
FRIDAY 5TH SEPTEMBER 1980.

Preparing the mortar:

- a.b. Two men shovel the mud from the edge of the basin 1 and pile it up into pile 2.
- c. A woman digs the edges of the preparation area and adds this drier earth to the mix.
- d.e. Two women make pile 3 from pile 2 and load the women carrying (2 shovelfuls each).

Carrying the mortar:

- f.g.h.i.j. 5 women load the mortar onto their shoulders (an empty cement sack covered with plastic over a wide jute cape). They climb up the scaffolding or directly up the walls on ladders.

Carrying the adobe blocks:

- k.l. 2 men carry blocks from the piles stocked to the building in wheelbarrows (3 or 4 blocks at a time).

Trimming the adobe blocks:

- m.n. A man and a woman trim, if necessary, the blocks with a pick and chisel.

Building the adobe walls:

- o.p.q.r. 4 men using shoulder bags and a sheep skin pad bring blocks to those laying them. They climb on the scaffolding or on the walls up ladders. (Weight of a block: approximately 25 kg).

Laying the adobe blocks:

- s.t.u.v. 4 men lay the blocks starting from the 4 corners. It takes two shovelfuls of mortar to lay 1 1/2 to 2 blocks. Vertical joints are filled with handfuls of mortar.

N.B.: The women fill in the external points, when the wall has barely been completed.

RECENT, CURRENT AND FUTURE RESEARCHES AND ACTIVITIES - AN OVERVIEW

La liste qui suit n'est pas exhaustive et ne donne qu'un aperçu général sur quelques-unes des activités en cours dans le domaine de la recherche sur le matériau terre.

COUNTRY	SUBJECT	CLIENT	EXECUTIVE AGENCY
Australia	World review of earth architectural models		HOWARD
Belgium	Production equipment Earth building technologies suitable for developing countries	AGCD UNCHS	UNATA PLATBROO
Brazil	Compressed block production equipment		TORSA - TECMOR
Denmark	Laterite lime stabilization Compressed block production equipment		LATOREX LATOREX
England	Lime stabilization Hydraulic press Renders (cement - sisal)		BRE BRE ITDG
France	Exploratory research - Definition of research areas Cold crystallization Cement-stabilized hollow extruded bricks Definition of earth production processes Production of earth Francois Cointeraux - Study of the evolution of rammed earth during the 18th and 19th centuries in Europe Presses + Production equipment Optimization of rammed earth application Reinforced stabilized earth - Beams - Floors - Ring-beams Earth housing in the city of Lyon Thermal Stabilization Insulating hollow cork blocks filled with earth Arches - Vaults - Domes Standards Formworks Modern renders Earth architecture around the world	PLAN CONSTRUCTION PLAN CONSTRUCTION PLAN CONSTRUCTION PLAN CONSTRUCTION DIRECTION DEL'AR PRIVATE PLAN CONSTRUCTION PRIVE	UPAG CRATERRE CTTB INSA AGRA CRATERRE GROUPE PISÉ AGRA UPAG-CNRS-UPA LYON UNDER PREPARATION CUST UTI - BTP CMRS

Next page 274

COUNTRY	SUBJECT	CLIENT	EXECUTIVE AGENCY
Germany	New application methods Compressed block production equipment Ethnology - Earth dwellings		GESANTHOCHSCHULE KASSFC KRUPP FROBENIUS
India	Architecture Renders		CBRI CBRI
Indonesia	Detecnologization of Latorex process		UN
Ivory Coast	Compressed blocks		IBTP
Kenya	Renders (cement - sisal)		
Mexico	Presses Review of existing documentation	PRIVE N.U.	N.U.
Nigeria	Stabilized laterite beams		UNIV. OF LAGOS
Peru	Earthquake resistant architecture Adobe press Methods of introducing new techniques etc. Standards Stabilized blocks		VIVIENDA CRATERRE PERU CRATERRE PERU VIVIENDA COBE COBE
Senegal	Renders		CEREEQ
Switzerland	Production equipment: - Mixers - Pulverizers - Presses Compressed blocks with external surface in fired earth Domes		CONSOLID MEILI EPFL EPFL
Togo	Compressed blocks Renders (natural stabilizers)		CCL CCL
Turkey	Standards		
Upper Volta	Architecture		ADAUA
U.S.A.	Thermal Adobe production equipment Compressed block production equipment Rammed earth production equipment Stabilization Adobe: - Identification - Restoration etc Earthquake-resistant housing		BICKLE GROUP QUIXOTE ADOBE SMITH BUILDERS REII DEPT OF COMMERCE INTERECT

GLOSSARY

ADOBE: Spanish word often used in English (and French) to refer to a mud brick. This technique consists in moulding earth bricks without compaction and allowing them to dry in the sun, hence their also being commonly known as Sun-dried bricks.

ASPHADOBE: Bitumen-stabilized adobe.

ATAKWA: Wall made up of thick bands of courses approximately 40 cm high by 20 to 30 cm thick. The earth is puddled with the feet and put into place and shaped by hand. This type of building work is still carried out by builders in Togo, Upper Volta and Benin.

BANCO: Synonymous with adobe and by extension used to mean any vertical wall which includes some processed earth. The walls can be made up of a crisscross framework of wood, reeds, bamboos held together with creepers, the gaps being filled in with worked earth and then smoothed on both sides and generally rendered with an earth render.

BITUDOBE: Bitumen-stabilized adobe (American origin).

CAJON: Type of earth construction in which panels are built with a mix of earth. The technique is similar to that used in Wattle and Daub or Hollow Frame Infill. 275

CHIKA:	Used to designate a render made of an earth and straw mortar. Amharic origin, Ethiopia.
COB:	A mixture of earth and straw used to build walls without formwork. A mix of water and crushed chalk was also used in the same way. - FRANCE ("bauge") - A fairly thick mix of sandy clayey soil, water and straw, applied in successive layers and without formwork; the walls are smoothed as work progresses. (Direct moulding).
COMPRESSED EARTH BRICKS OR BLOCKS:	The earth is tamped in a mould or compressed using a press.
CUT EARTH BLOCKS:	The block is cut directly from a pit without preparation or mixing of the soil.
DAGGA:	Mix of clay, sand and water used as a mortar to lay compressed earth blocks and as a render to protect the walls. A stabilizer is often added.
DAUB:	An earth mortar applied with a trowel or by hand to both sides of a lattice framework to make a thin wall. (See Wattle and daub).
DIRECT MOULDING:	See Cob, Atakwa.
GEOCONCRETE:	Soil cement used according to the GEOTEK process for earth construction.
HOLLOW FRAME WITH INFILL:	Wooden double-layer framework, the gap between the layers being filled with mud infill, rubble, or any other suitable material. In this process the earth is not load-bearing, but serves only as an infill.
JLOOS:	Earth construction of Sudanese origin.
KACHA:	Earth construction of Indian origin.
LATH AND PLASTER:	Mix of soil and water bonded by fibres used with a wooden structure to build walls. (In French: "torchis".)
MECATER:	Other name for stabilized soil concrete.
MUD BALLS:	Mud often mixed with straw, prepared in a similar way to adobe, except in this case there is no mould, the balls are shaped and left to dry on the spot and then used to build walls.
276 MUD BLOCKS OR BRICKS:	See Adobe.

- PISE:** See Rammed earth.
- POURED EARTH:** Earth in a liquid state poured between two forms, either along the whole length of the wall or gradually. Shrinkage cracks are filled in after drying.
- RAMMED EARTH:** A technique enabling one to build walls in single sections with earth which is compacted in a formwork with a rammer. Often known by its French name Pisé.
- RAMMER:** Heavy weight used to compact earth between shuttering, also known as a Tamper.
- SOD OR SODDYS:** See Turf-building.
- SOIL CEMENT:** Recent term regarding the material as a correctly proportioned mix of gravel, sand and silt bound by clay. S.S.C.: Stabilized soil concrete.
- STABILIZED EARTH:** Refers to the mixture of sandy clay, water and a given quantity of stabilizing agents such as lime, cement, bitumen emulsions etc. These stabilizers increase water-resistance. Used for making walls, bricks... Also used to mean the mix used in road construction.
- STABILIZED SOIL CONCRETE:** Soil concrete in which a stabilizing agent (cement, lime, bitumen...) improves its quality (compressive strength, impermeability, etc...)
- SUN-DRIED BRICKS OR BLOCKS:** See Adobe.
- SWISH:** Refers to the laterite - swish-crete = mix of laterite and cement - Ghana.
- TAIPA:** Wattle and daub of Portuguese origin.
- TAMPER:** See Rammer.
- TAPIA:** Term used in Peru for rammed earth.
- TAUF:** Arabic for rammed earth.
- TERONI:** Process similar to adobe bricks and soddys: turf blocks are cut out of the soil, sun-dried, and used to build walls. A church built using this method in 1621 in New Mexico is still in good condition.

TERRACRETE:
TORCHIS:

Cement-stabilized soil cement. American origin.
French term referring both to the infill material used during the process known as Lath and plaster (see above) and the process itself.

TOUB:

Mud brick - Arabic and French.

TUBALI:

West African name for pear-shaped bricks, hand-moulded from a mix of earth, water, and pieces of fresh or dry grass. The Tubalis are placed three or four deep, their swollen end laid in mortar; the following layer is laid so that the swollen ends are facing the same way as the pointed end of the previous layer. Nigerian origin.

TURF-BUILDING:

Houses in which the walls and occasionally the roofs are built out of turf; the grassy side is generally placed facing downwards. This type of building was widely used in the United States, where it was known as SOD or SODDYS. Nebraska and Kansas origin.

WATTLE AND DAUB:

Method in which an earth render is applied to a wooden structure to which a lattice of interlaced twigs and osiers has been attached. The process is repeated until all the gaps have been filled.

LIST OF ORGANIZATIONS

Algeria

CNERIB
Cite Mokrani Nouvelle - Souidania - Wilaya Tipaza
Earth in general

LNBTP

Route des 4 Canons - Alger
Compressed earth blocks

Germany

CRATERRE

53 Jahnstrasse - 6100 Darmstadt
Straw - clay

GESAMTHOCHSHULE KASSEL
FORSCHUNGLABOR FUR EXPERIMENTELLES BAUEN
FB 12. Postf 101380 - 13 Menzellstrasse - Kassel
New technology and magazine

Belgium

CRA

UCL - DA VINCI
1, place du Levant - 1348 Louvain La Neuve
Case studies

CRATERRE BELGIUM

57, rue Franz Merjay - 1060 Bruxelles
Earth in general and iconographic documents

HET LEMEN HUIS

7 Sint Petrusstraat - 3404 Attenhoven
Wattle and dab

PGC HS

Kul Kasteel Arenberg - 3030 Heverlee
Case studies

Brazil

CEPED

Caixa postal 09 42800 - Camacari - Bahid
Rammed earth

Burkina Faso

ADAUA
BP 648 - Ouagadougou
NGO - Construction

Ivory cost

LBTP

BP 4003 - Abidjan
Compressed earth block and caracterisation

France

CEBTP

12 rue Brancion - 75737 Paris Cedex 15
White wash

CRATERRE

Les Rivaux - Brie et Angonnes - 38320 Eybens
Earth in general and international promotion

CSTB

24 rue Joseph Fourier - 38400 St Martin d'Herès
Fondamental mecanism

ECOLE D'ARCHITECTURE DE GRENOBLE

CEAA ARCHITECTURE DE TERRE
10, Galerie des Baladins - 38100 Grenoble
Post graduate course on earth wirst ruction

ENTPE

Rue Maurice Audin - 69120 Vaulx-en-Velin
Caracterisation

GROUPE PISE

Place Saint Vincent de Paul - 01400 Chatillon-sur-Chalaronne
Rammed earthx00

INSA DE LYON ET RENNES

20, avenue des Buttes de Coesmes - 35031 Rennes
Extruded earth and compressed earth blocks

Ghana

BRII

MATERIALS DIVISION
P.O. Box 40 University - Kumasi
Compressed Paterite blocks

Grande-Bretagne

BRE
Overseas Division - Garston Watford WD2 7 JR
Stabilization and compressed earth block

ITDG
Myson House - Floor 3 - Railway Terrace - Rugby CV 21 3HT
Earth in general

Guatemala

CENTRO DE INVESTIGACIONES DE INGENIERIA
Ciudad Universitaria - Zona 12 - Guatemala C.A.
Rammed earth and earth quakes

India

ASTRA
INDIAN INSTITUTE OF SCIENCE
Bangalore 560012
Characterisation

CBRI
Roorkee - Uttar Pradesh
Protection

Indonesia

INSTITUTE OF HUMAN SETTLEMENTS
BUILDINGS MATERIALS DIVISION
Ministry of Public Works - 84 Jalan Tamansari - Bandung
Compressed laterite blocks stabilized with lime Italia

Italie

ICCROM
13 via di San Michele - 00153 Roma
Preservation

Mali

ADAUA
B.P. 2470 - Bamako
Adobe and protection

Marocco

LPEE
B.P. 389 - 25 rue d'Azilal - Casablanca
Characterisation

Mexico

INSTITUTO DEL ADOBE
UNAP
21 Sur 1103 - CP 72000 - Puebla
Adobe

UNAM
CENTRO DE INVESTIGACION DE MATERIALES
Apartado postal 70-360 - Mexico 20, D.F.
Adobe and seisms

Peru

CRATERRE PEROU
Apartado Postal 399 - Huancayo
Earth in general

ININVI
PONTIFICIA UNIVERSIDAD CATOLICA DEL PERU
Apartado 12534 - Lima 21
Adobe and seisms

Senegal

CEREEQ
B.P. 189 - Dakar - Hann
Protection

Sudan

NCR
HOUSING AND ENGINEERING UNIT
P.O. Box 6094 - Khartoum
Compressed earth blocks

Thailand

THAILAND INSTITUTE OF SCIENTIFIC
AND TECHNOLOGICAL RESEARCH
Building Research Division - 196 Phahonyothin
Bangkhen - Bangkok 10900
Compressed earth blocks

Togo

CENTRE DE LA CONSTRUCTION ET DU LOGEMENT
CACAVELLI
B.P. 1762 - Lome
Earth in general

Tunisia

INSTITUT TUNISIEN DE TECHNOLOGIE APPROPRIEE
Sidi Bou-Ali 4040 - Tunisie
Earth in general

USA

ADOBE TODAY
2312 Central Avenue S.W. - P.O. Box 7460 - Albuquerque
New Mexico 87194
Magazine

ESDI
P.O. Box 1217 - Corrales
Magazine

IFEC
2501 M Street - Suite 450-N.W. - Washington D.C. 20037
International Promotion

INTERTECT
P.O. Box 10502 Dallas - Texas
Building in disaster-prone areas

REII
2319 21 ST. Avenue - Greeley, CO 80631
Rammed earth

VITA
3706 Rhode Island Avenue - Mt. Rainier - Maryland 20822
Faith in general

VOLUNTEERS IN ASIA
P.O. Box 4543 - Stanford - California 94305
Microfilm Library

BIBLIOGRAPHY

Many books and documents have been published over the last few years. We list here a selection of the best works easily accessible to the general public. If your library has any difficulty in obtaining them, please contact the following two groups which specialise in the distribution of buildings and architectural works; we can vouch for their diligence and efficiency.

● Editions Parentheses
Les Plâtrières - 13360 Roquevaire France

● Krauthammer
24 Obere Zäune - 8001 Zürich Suisse

GERMAN

Architektur der Vergänglichkeit Lehmbauten der Dritten Welt

Adam, J.A. et al
München, Die Neue Sammlung Staatliches Museum für angewandte Kunst, 1981

Wohn- und Siedlungsformen im Süden Marokkos

Adam, J.A.
München, Georg D.W. Callwey, 1981

Lehmarchitektur. Die Zukunft einer vergessenen Bautradition

Dethier, J.
München, Prestel, 1982.

Auch in Lehmhaus lässt sich's leben

Gardi, R.
Paris-Bruxelles, Elsevier Séquoia, 1974.

Lehmarchitektur, Rückblick-Ausblick.

Gate
Frankfurt am Main, Gate, 1981.

Lehmarchitektur in Spanien und Africa

Lender H., Niermann, M.
Langewiesche, Karl Robert, 1980.

Alternatives Bauen

Minke, G.
Kassel, Gesamthochschule, 1980.

Der Lehm, seine praktische « Anwendung »

Niemeyer, R.
Griebenstein, Oko, 1982.

Am Anfang die Erde-sanfter Baustoff Lehm

Schneider, J.
Frankfurt/Main, Fricke im Rudolf Müller, 1985

Leichtlehm

Volhard, F.
Karlsruhe, CF Müller GmbH, 1983.

Die Lehmarchitektur der Pueblos

Wienands, R.
Köln, Studio Dumont, 1983

ENGLISH

Adobe codes from around the south west

Adobe News
Albuquerque, Adobe News, 1985.

Mud, mud

Agarwal, A.
London, Earthscan, 1981

Build your own adobe

Aller, P. and D.
Stanford, Stanford university press, 1978

Dirt cheap, the mud brick book

Archer, J. and G.
Melbourne, Compendium Pty, 1980.

The sod house

Barns, C.G.
Lincoln/London, Bison book, University of Nebraska press, 1970.

Making the adobe brick

Boudreau, E.H.
California, Fifth Street press, 1974

Spectacular Vernacular, a new appreciation of traditional desert architecture

Bourgeois, J.L. ; Pelos, C.
Salt Lake City, Gibbs M. Smith, 1983

Early architecture in New Mexico

Bunting, B.
Albuquerque, University of New Mexico press, 1976

Taos adobes

Bunting, B. et al.
Santa Fe, Fort Burgwin research center Museum of New Mexico, 1975

Of earth and timbers made

Bunting, B. ; Lazar, A.
Albuquerque, University of New Mexico press, 1975

Soil cement, its use in building

CINVA
New York, United Nations, 1964

African traditional architecture

Denyer, S.
New York, Africana, 1978.

Mud brick roofs

Department of housing and urban development
Washington, Office of International Affaires, 1973

Down to earth, mud architecture : an old idea, a new future

Dethier, J.
London, Thames and Hudson, 1982

The rammed earth experience

Easten, D.
Wilseyville, Blue Mountain press, 1982

Home sweet dome

Ebert, W.M.
Frankfurt am Main, Dieter Fricke GmbH, 1981

Architecture for the poor

Fathy, H.
Chicago, University of Chicago press, 1973

Manual on stabilized soil construction for housing

Fitzmaurice, R.
New York, United Nations, 1958

Rural shelter in Southern Africa

Frescura, F.
Pretoria, Sigma press, 1981

Adobe designs

Gano, E.J.
Pueblo, Gano, 1980

How to build adobe houses... etc

Garrison, P.
USA, Tab books, Blue Ridge Summit, 1979.

Mud space and spirit

Gray, V. ; Macrae, A.
Santa Barbara, Capra press, 1976

Adobe a comprehensive bibliography

Hopson, R.C.
Santa Fe, The lightning tree, 1980

Holy Adobe

Hughes, L.H.
El Paso, Hughes publishing Co, 1981

The manufacture of asphalt emulsion stabilized soil bricks and bricks makers manual

International Institute of Housing Technology
Fresno, IIHT, 1972

Local materials. A self builder's manual

Kahane, J.
London, Publication Distribution Co-operative, 1978

Rammed earth

Kern, K.
Owner builder publications California, 1980

The owner built home

Kern, K.
New York, Charles Scribner's Sons, 1975

We are what we stand on

Knox, A.
Eltham, Adobe press, 1980

Adobe, past and present

Lumpkins, W.
Albuquerque, University of New Mexico printing plant, 1974

Casa del Sol

Lumpkins, W.
Santa Fe, Santa Fe Publishing Co, 1981

Adobe and rammed earth buildings

McHenry, P.G.
New York, John Wiley and Sons, 1984.

Adobe, build it yourself

McHenry, P.G.
Tucson The University of Arizona press, 1974

Build your house of earth

Middleton, G.I.
Victoria, Compendium Pty, 1979

Manual for building a rammed earth wall

Miller, L. and D.
Greeley, REII, 1980

Rammed earth, a selected world bibliography

Miller, L. and D.
Greeley, REII, 1982

The owner-built adobe house

Newcomb, D.G.
New York, Charles Scribner's Sons, 1980

The adobe book

O'Connor, J.F.
Santa Fe, Ancient City press, 1973

Shelter in Africa

Oliver, P.
London, Barrie and Jenkins, 1971

Adobe craft, illustrated manual

Schultz, K.V.
Castro Valley, Adobe craft, 1974

The portalab manual

Scoggins, H.
Alamogordo, N.M. Appropriate technology program, 1982

Adobe bricks in New Mexico

Smith, E.W.
Socorro, Circular 188, New Mexico Bureau of Mines and Mineral Resources, 1982

Build with adobe

Southwick, M.
Chicago, the swallow press, 1971

Adobe architecture in New Mexico,
Stedman, M.L.
Santa Fe, The sunstone press, 1971

Adobe remodeling
Stedman, M.L.
Santa Fe, The sunstone press, 1976

Appropriate building materials
Stulz, R.
St. Gallen, SKAT, 1981

**Adobe, in the Americas and around the world history,
conservation and contemporary use.**
UNDP/UNESCO
Travelling exhibition. Lima, UNDP/UNESCO, 1984

Homegrown sundwellings
Van Dresser, P.
Santa Fe, The lightning tree, 1979

**So you want to see a solar building? A tour guide for
northern New Mexico**
Wells, M ; Williamson, J.
Santa Fe, NMSEA, 1983

Sod walls
Welsch, R.L.
Nebraska, Purcells Inc, 1968

Handbook for building homes of earth
Wolfskill, L.A. et al.
Greeley, REII, 1983

BRAZILIAN

Arquitetura de terra ou o futuro de uma tradicao milenaria
Dethier, J.
Rio de Janeiro, Avenir Editoria Limitada, 1984

SPANISH

Barro, Barro !
Argawal, A.
London, Earthscan, 1981

Arquiteturas de adobe
Bardou, P. ; Arzoumanian, V.
Barcelona, GG, 1979

Seguir construyendo con tierra
CRATerre
Lima, Mesa Redonda, 1984

FRENCH

Bâtir en terre
Agarwal, A.
London, Earthscan, 1981

Archi de terre
Bardou, P. ; Arzoumanian, V.
Marseille, Editions Parenthèses, 1978

**Le béton de terre stabilisé et son emploi dans les travaux
de construction**
CINVA
New York, Nations Unies, 1964

Construire en terre
CRATerre
Paris, éditions Alternatives et Parallèles, 1979

**L'Architecture de terre, Bâtiments caractéristiques de la
région Rhône-Alpes**
CRATerre ; Groupe Pisé
Bourg-en-Bresse, CAUE de l'Ain, 1983

**Des architectures de terre, ou l'avenir d'une tradition
millénaire**
Dethier, J.
Paris, CCI, 1981

Construire avec le peuple
Fathy, H.
Paris, éditions Jérôme Martineau, 1970

Manuel de constructions en béton de terre stabilisée
Fitzmaurice, R.
New York, Nations Unies, 1958

Maisons africaines
Gardi, R.
Paris-Bruxelles, Elsevier Séquoia, 1974

ITALIAN

Moschee in adobe, storia e tipologia nell'Africa Occidentale
Ago F.
Roma, Kappa, 1982

Le case di terra, memoria e realta
CLUA
Pescara, CLUA, 1985

Architetture di terra
Dethier, J.
Milano, Electra, 1982

Le meraviglie dell'architettura in terra cruda
Galdieri, E.
Roma, Editori Laterza, 1982



CON TIERRA

Realidad socio-economica de la construccion con tierra en zona andina — valle del Rio Mantaro — Peru

(Still earth construction : Socio economic reality of earth construction - Rio Mantaro Valley - Peru).

Abelardo Vildoso

Flor de Maria Monzon

CRATerre: Alain Hays, Sylvia Matuk, Francois Vitoux

Spanish, 1984, 310 pages, 140 illustrations.

Editor and distribution: CRATERRE — MESA REDONNA Antonio Roca 138 Santa Beatriz LIMA 1 — PEROU

Most of the time, earth construction is the only solution for peasants of Peruvian Andes to realise their homes, schools or community buildings. In urban areas earth offers an alternative to the difficult economic situation. Their study was launched through a series of questions: What are the factors enabling this building material to operate within the constitution of rural and urban habitat? How is their building material perceived and accepted and which tendencies can be observed in the further developments? In answering these questions the perception of the actual users was preferred: farmers, builders and local authorities express their opinions. Their study analyses, through site surveys, the problem from different points of view; social, economic and institutional considerations illustrate the potentials and constraints of the continuation of earth construction in rural and urban peruvian building sector. The document also indicates promotional activities taking into account the specificity, social and cultural identity of the people involved. As such one chapter is dedicated to the description of the working methodology and activities of the CRATERRE project for technical assistance. This project is intended to stabilize and upgrade indigenous earth construction technologies in the rural communities of the Montero Valley

LEICHTLEHMBAU

Alter Baustoff — Neue Technik

(Building with straw-clay: An ancient building material — a new technique)

Franz Volhard

in collaboration with Ute Shaver

German, 1983, 156 pages, 172 Illustrations

Editor and distribution: Verlag C.F. Muller Postfach 4320 D 7500 Karlsruhe FRG

This building technique of straw-clay, recently rehabilitated, combines structural properties, insulation and cohesiveness of three natural building materials: wood, straw, clay. This book explores all possible combinations of these three basic materials for the redisation of walls, floors and insulative roofs. The potentials for execution are diversified from publication to on job-site redisation. The properties of thermal insulation, lightness and flexibility in use make that straw-clay knows a rapid dissemination or well for new constructions or for rehabilitation of ancient walls and Haub structures. This book constitutes a real practical hand book for the design and redisation art is based on practical experience gained in several self-built projects. All this is accompanied by descriptions of the technical performances of the material: thermal, acoustic and fire resistance. One section is dedicated to surface protection and a complete chapter deals with cost considerations and duration of all execution phases.



(EARTH CONSTRUCTION PRIMER)

CRATerre: Hugo Houben

Hubert Guillaud

French, 1989, 355 pages, 675 illustrations

Editor and distribution: Ed. Parenthèses 72, Cours Julien, 13906 Morseille, France

Since the publication of "Construire en terre" which is actually upto its 3rd edition, CRATERRE, emphasizes its will for large dissemination of knowledge and accumulated experience dealing with earth construction. This dissemination is essential to assure appropriate project design and to promote strategic of information and training, both for professionals and universities. The earth construction primer was realized in 1984 on behalf of the United Nations for Human Settlements (UNCHS - Habitat; Nairobi, Kenya) and was published in French in 1969. This didactic manual provides the user with scientific background and basic technical information for information and training oriented towards a vast audience: decision makers, planners, architects, entrepreneurs, site managers, masons, self-builders. This handbook is the form for the theoretic and practical post graduated course on earth construction organised by CRATERRE within the School of Architecture in Grenoble. Twelve chapter and 165 information sheets contain all necessary fundamental knowledge essential for the theory and practical of earth construction. Therefore this document is unique. Hundreds of illustrations, original showings, tables and graphs create tools for operational design and execution. This handbook must be considered or an unavoidable incentive for indepth trainings leading to efficient and illustrative practice.

In trying to 'catch up with the West' many developing countries including those in Asia have imported inappropriate, energy-intensive, capital-intensive and anti-ecological technologies, the most notable are being our modern hi-tech construction industry. In this process local resources and local systems of knowledge-cum-practise underwent a systematic degradation and erasure. Natural renewable resources like mud faced this attack especially in the Industrial Age and earth construction became virtual taboo ... with it Asian countries lost their heritage.

Building with Earth not only explodes the myths about this natural material but shows the way of the *hows* and *whys* that go in this construction process. It spans different continents and time-frames right upto contemporary times. A versatile, lucidly written, prolifically-illustrated and well-circulated book that is authored by five professionals from CRATerre, the International Centre for Earth Construction in France. This 300-page book addresses itself both to the technical and non-technical persons.

The Mud Village Society, New Delhi, India brings forward the first English Edition of *Building With Earth* to its readers in the developing countries of South Asia. The Mud Village Society is an NGO engaged in appropriate and indigenous technology, art, architecture and energy conservation in consonance with the eco-system. It is actively involved in building natural habitats by working in harmony with Nature.

Publishers:

*the
mud village society*

Paperback Edition
Rs. 350/- only
(India)

CRATerre

Centre for Earth Construction - BP 43
34100 VILLFONTAINE - France